

Pathway towards achieving 100% renewable electricity by 2050 for South Africa

Oyewo Ayobami Solomon, Aghahosseini Arman, Ram Manish, Lohrmann Alena,
Breyer Christian

This is a Final draft version of a publication
published by Elsevier
in Solar Energy

DOI: 10.1016/j.solener.2019.09.039

Copyright of the original publication: © 2019 International Solar Energy Society

Please cite the publication as follows:

Oyewo, A. S., Aghahosseini, A., Ram, M., Lohrmann, A., Breyer, C. (2019). Pathway towards achieving 100% renewable electricity by 2050 for South Africa. *Solar Energy*, vol. 191. pp. 549-565. DOI: 10.1016/j.solener.2019.09.039

**This is a parallel published version of an original publication.
This version can differ from the original published article.**

Pathway towards achieving 100% renewable electricity by 2050 for South Africa

Ayobami Solomon Oyewo, Arman Aghahosseini, Manish Ram, Alena Lohrmann, Christian Breyer
LUT University, Yliopistonkatu 34, 53850 Lappeenranta, Finland
E-mail: solomon.oyewo@lut.fi and christian.breyer@lut.fi

Abstract

Transition to a cost effective and fossil carbon-free energy system is imminent for South Africa, so is the mitigation of issues associated with the ‘water-energy nexus’ and their consequent impacts on the climate. The country’s key fossil carbon mitigation option lies in the energy sector, especially in shifting away from the coal-dependent power system. Pathways towards a fully decarbonised and least cost electricity system are investigated for South Africa. The energy transition is simulated for five scenarios, assessing the impact of various factors such as sector coupling, with and without greenhouse gas (GHG) emission costs. South Africa’s energy transition is simulated using an hourly resolved model until 2050. This modelling approach synthesises and reflects in-depth insights of how the demand from the power sector can be met. The optimisation for each 5-year time period is carried out based on assumed costs and technological status until 2050. The modelling outcomes reveal that solar PV and wind energy, supplying about 71% and 28% of the demand respectively in the Best Policy Scenario for 2050, can overcome coal dependency of the power sector. The levelised cost of electricity increases just slightly from 49.2 €/MWh in 2015 to 50.8 €/MWh in the Best Policy Scenario, whereas it increases significantly to 104.9 €/MWh in the Current Policy Scenario by 2050. Further, without considering GHG emissions costs, the cost of electricity slightly increases from 44.1 €/MWh in 2015 to 47.1 €/MWh in the Best Policy Scenario and increases up to 62.8 €/MWh in the Current Policy Scenario by 2050. The cost of electricity is 25% lower in the Best Policy Scenario than in the Current Policy Scenario without factoring in GHG emissions costs and further declined to 50% with GHG emissions costs. The Best Policy Scenario without GHG emissions costs led to 96% renewables and the remaining 4% is supplied by coal and gas turbines, indicating pure market economics. The results indicate that a 100% renewable energy system is the least-cost, least-water intensive, least-GHG-emitting and most job-rich option for the South African energy system in the mid-term future. No new coal and nuclear power plants are installed in the least-cost pathway, and existing fossil fuel capacities are phased out based on their technical lifetime.

Keywords: South Africa, Coal, Energy transition, 100% Renewable energy, Decarbonisation

Nomenclature

A-CAES	adiabatic compressed air energy storage	LCOS	levelised cost of storage
BPS(s)	Best Policy Scenario(s)	LCOT	levelised cost of transmission
CAPEX	capital expenditures	OCGT	open cycle gas turbine
CCGT	combined cycle gas turbine	OPEX	operational expenditures
CCS	carbon capture and storage	PHES	pumped hydro energy storage
CHP	combined heat and power	PV	photovoltaic
CPS(s)	Current Policy Scenario(s)	RE	renewable energy
CSP	concentrating solar thermal power	RoR	run-of-river
		SNG	synthetic natural gas

DOE	Department of Energy	ST	steam turbine
GT	gas turbine	TES	thermal energy storage
GHG	greenhouse gas	VRE	variable renewable energy
HVDC	high voltage direct current	WACC	weighted average cost of capital
IRENA	International Renewable Energy Agency	ZAR	South Africa Rand
IPPs	Independent Power Producers		
IRP	Integrated Resource Plan		
LCOC	levelised cost of curtailment		
LCOE	levelised cost of electricity		

1. Introduction

South Africa is the fifth most populated country in Africa, with a population of 56.7 million in 2017 and an annual average population growth rate of 1.2%, occupying an area of 1.219 million km² (World Bank, 2017). The country's GDP is 349 b€ with a growth rate of 1.3% in 2017 (World Bank, 2017). The electricity demand is expected to increase from 245 TWh in 2015 to 522 TWh in 2050, with an annual average growth rate of 2.3% (Wright et al., 2017). South Africa, like any other coal-abundant country, is susceptible to huge environmental crises, due to over-reliance on coal-generated electricity (Baker and Sovacool, 2017; Klausbrucker, 2016). Coal-fired power plants account for over 90% of electricity production in South Africa (Menyah and Wolde-Rufael, 2010). The country is listed amongst the world's most fossil carbon-intensive economies and is ranked as the 7th largest emitter of greenhouse gas (GHG) per capita (Alton et al., 2014). In Africa, South Africa remains the largest CO₂ emitter and accounts for 42% of the continent's emissions (Alton et al., 2014). South Africa commits, as defined in national policy, a peak, plateau and decline GHG emissions trajectory range, with emissions by 2025 and 2030 in a range of between 398 and 614 Mt_{CO₂eq}, as per the 2015 intended nationally determined contribution (DEA, 2015). The country's main fossil carbon mitigation option lies in shifting away from its coal dependence in the power sector (DEA, 2015), which complies with the Paris Agreement on climate change (Delina and Sovacool, 2018). Transition towards renewable energy is highlighted in the Paris Agreement for mitigating climate change (Delina and Sovacool, 2018). Figure 1 shows the total active installed capacities, by the end of 2014 in South Africa, and illustrates the almost complete reliance on fossil fuel (Farfan and Breyer, 2017). Additional background information on South Africa is available in the Supplementary Material (section 1).

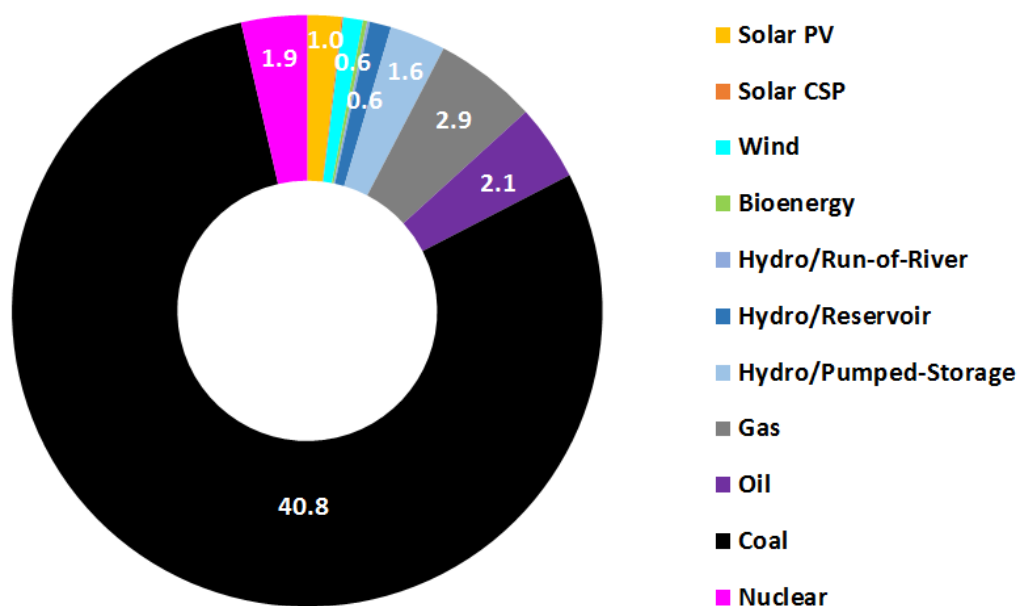

Figure 1. Total installed active power capacities (in GW) by the end of 2014 in South Africa (Farfan and Breyer, 2017).

A brief summary of various studies on the trend of RE share in the South African energy system is presented in Table 1.

Table 1: Studies on trends of renewable energy shares in the South African energy system

Reference	Findings
Greenpeace (2011a)	The Advanced Energy [R]evolution scenario projects a renewable electricity share in the South African energy system of 49% by 2030 and 94% by 2050. The installed capacity of RE will reach 59 GW in 2030 and 114 GW in 2050. Solar PV, wind energy and CSP dominate the shares of installed capacity, contributing 40 GW, 27 GW and 35 GW respectively by 2050.
IEA (2015)	The South African power system is dominated by coal with 54.2 GW and 42.9 GW in the Baseline and Efficiency scenarios respectively, by 2030. RE installed capacity is 20.1 GW (23%) of 86.6 GW in the Baseline scenario, and 23.7 GW (31%) of 77.4 GW in the Efficiency scenario.
IEA (2014)	The New Policy Scenario assumes RE installed capacity of 35 GW and fossil power plants of 73 GW by 2040. Coal dominates the installed capacity with 53 GW (49%). Coal and nuclear contributes 243 TWh (61%) and 47 TWh (12%) respectively of the total electricity generation at 401 TWh by 2040.
IRENA (2013)	Under the Renewable Promotion Scenario, South Africa's RE installed capacity reached 37.5 GW (43%) and fossil is 50.2 GW (57%). Coal dominates the installed capacity with 41.5 GW (47%), followed by wind energy and solar PV with 17.3 GW (20%) and 13.9 GW (16%) respectively by 2030.
Wright et al. (2017)	The least cost ('Expected' costs) scenario achieves over 70% RE penetration by the year 2050, with a significant investment in solar PV and wind energy as expected, with gas turbines providing system flexibility and adequacy with hydropower and biomass. Storage and remaining coal capacity assist in system adequacy. By 2050, energy mix is dominated by solar PV with 140 GW and followed by wind with 73 GW. Solar PV and wind dominate in this scenario due to a further cost reduction assumed for PV and wind. The decarbonised scenario achieves over 90% RE penetration by 2050. Solar PV and wind energy dominate the total installed capacity, with 84 GW and 83 GW respectively by 2050.

	In addition, solar PV and wind energy are complemented by biomass (16 GW), CSP (13 GW), hydro (9 GW) and gas turbines (43 GW).
WWF Vision 2030 (2014)	RE capacity of 35 GW (37%) and 18 GW (24%) is projected for the high-demand and low-demand scenarios respectively, by 2030. While, renewable electricity generation is 78 TWh (19%) for the high-demand scenario and 39 TWh (11%) for the low-demand scenario.

This article explores the paradigmatic and dynamic pathway to a fully decarbonised and least cost electricity solution for South Africa in the mid-term future. A 100% RE scenario for South Africa is simulated using an hourly resolved model, from 2015 to 2050, covering the power sector demand. Furthermore, the water-energy nexus is explored through analysing the water footprint of the different energy scenarios. In addition, another crucial aspect for South Africa is the creation of local employment, which is further analysed for the different energy scenarios in this research. The paper is structured as follows: the research methodology is described in section 2. Results are presented and analysed in section 3. In section 4, the results are discussed and compared with related studies. Conclusions and policy implications are presented in section 5.

2. Methods

2.1. Overview

The South African energy system was modelled with the LUT Energy System Transition Model described in (Bogdanov and Breyer, 2016; Breyer et al., 2018; Bogdanov et al., 2019). The energy system model is a linear optimisation tool developed to determine the optimal investment and generation technology mix required to meet the electricity demand in South Africa from 2015 until 2050. The main objective of this research is to understand the transition pathways to a fully RE-based power system for South Africa. The optimisation for each time period (5-year intervals) is carried out on the basis of assumed costs and technological status until 2050 for all energy technologies involved. The installed capacities of the different types of power plants from 1960 to 2015 is considered according to Farfan and Breyer (2017). Additionally, the water footprint analyses are based on Lohrmann et al. (2019) and employment creation is based on Ram et al. (2017a). After 2015, there are no additional capacities of fossil fuel resources allowed. The existing fossil power plants are phased out based on their lifetimes. However, gas turbines can be installed after 2015, due to their lower GHG emissions, higher efficiency, and the possibility to accommodate bio-methane and synthetic natural gas in the power system in a later phase. The RE capacity share increase cannot exceed 4% per year (3% per year from 2015 to 2020), in order to avoid disruptions.

2.2 Model overview

The power system used in this study was developed to match generation and power demand for every hour of the simulated year. The model is based on linear cost optimisation of energy system parameters under certain constraints. The model is compiled using MATLAB R2016a (MathWorks, 2016), while the optimisation is carried out in MOSEK version 8 (Mosek, 2017). The key target function of the model is to optimise the system, so that the total annual energy system cost is minimised. This cost is calculated as the addition of the annual costs of the installed capacities of each technology, operational expenditures, and costs of generation ramping. In addition, the energy system takes into account self-generation and consumption of electricity for residential, commercial and industrial end-users. Another mini-transition hourly model describes the PV prosumers systems and optional battery development capacity. The respective capacities of rooftop PV systems and optional batteries are installed by the prosumers. The target function for prosumers is the minimisation of cost of consumed electricity, calculated as the sum of self-

generation, annual costs, and the cost of electricity consumed from the grid. Excess electricity is sold to the grid at 0.02 €/kWh by prosumers, when their own demand is satisfied, but not more than 50% of total self-generation. The prosumer demand is limited to 20% of the total demand. The prosumer constraints ensure that the 20% is not reached within the first time step. Thus, the model determines a step-wise progression from a maximum of 6% in the first time step to 9%, 15%, 18% and 20% in subsequent time steps if the economic model of prosumers indicates benefits of PV self-generation. PV self-consumption is considered as an exogenous input into the system optimisation. The energy system is optimised in addition to the prosumer capacities, which avoid any distortion of the overall system. The model overview is shown in Figure 2. Detailed model description, equations and applied constraints can be found in (Bogdanov and Breyer, 2016; Breyer et al., 2018; Bogdanov et al., 2019).

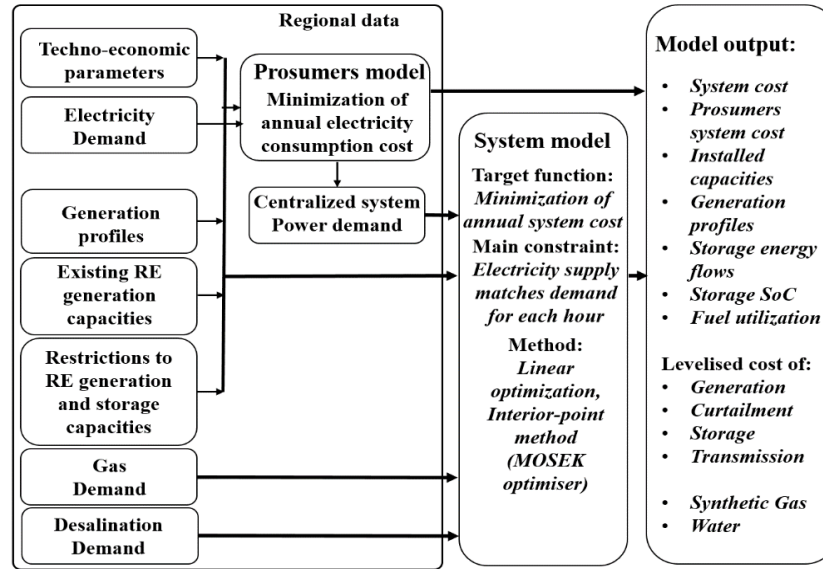

Figure 2. Main inputs and outputs of the LUT Energy System Model (Bogdanov and Breyer, 2016).

South Africa was structured into 9 sub-regions based on the existing provincial structure, namely, Gauteng (ZA-GT), Mpumalanga (ZA-MP), KwaZulu-Natal (ZA-NL), North West (ZA-NW), Limpopo (ZA-LP), Western Cape (ZA-WC), Free State (ZA-FS), Eastern Cape (ZA-EC) and Northern Cape (ZA-NC). All the sub-regions are interconnected with transmission grids as shown in Figure 3.

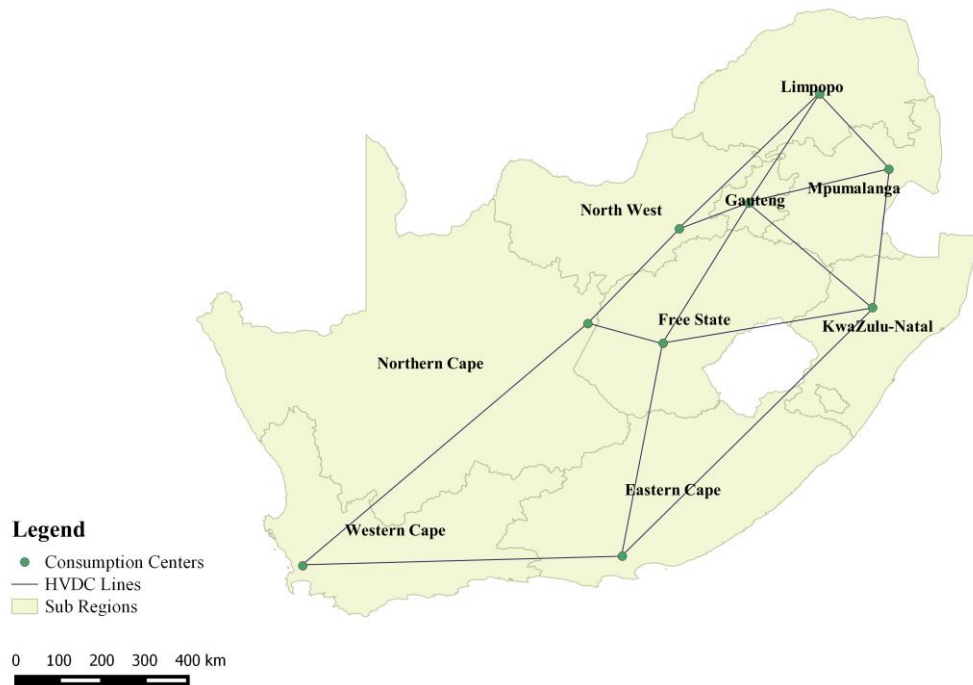

Figure 3. South African sub-regions and transmission lines configuration.

2.3 Applied technologies

The main technologies applied for the South African energy system modelling include electricity generation, storage, transmission and energy sector bridging technologies to provide more flexibility to the complete energy system. Figure 4 shows the block diagram of the energy transition model.

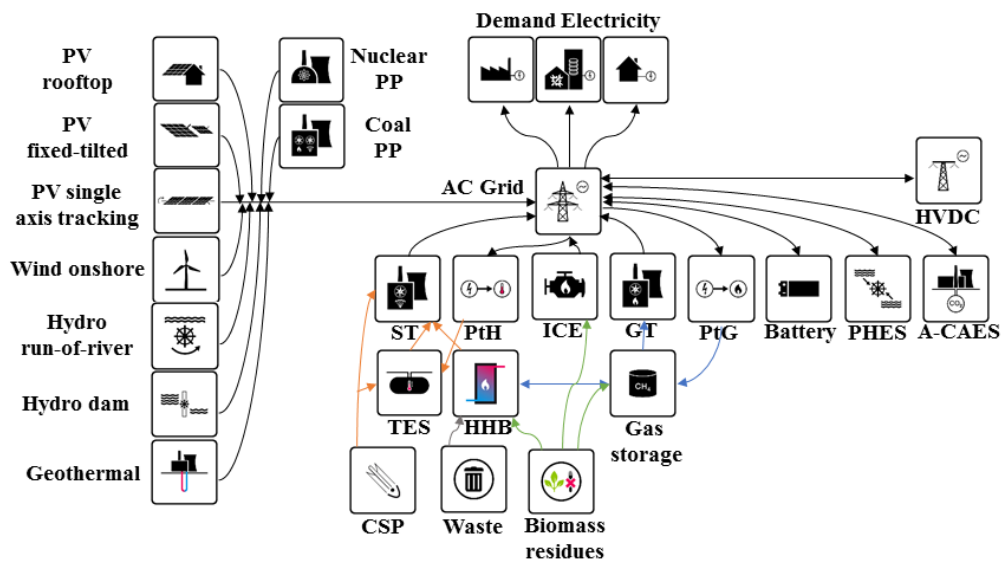

Figure 4. Block diagram of the LUT Energy System Transition model used for South Africa (Breyer et al., 2018). Abbreviations not introduced elsewhere include PP- power plant, ST- steam turbines, PtH – power-to-heat, ICE – internal combustion engine, GT gas turbines, A-CAES – adiabatic compressed air storage,

PtG- power-to-gas, PHES – pumped hydro energy storage, TES – thermal-energy-storage, HHB – hot heat burner, CSP – concentrated solar thermal power.

2.4. Modelling assumptions

2.4.1. Financial and technical assumptions

The financial and technical assumptions for all energy system components are applied in 5-year time steps. This includes operational expenditures (OPEX), capital expenditures (CAPEX) and technical lifetimes from 2015 to 2050 for the applied technologies, as provided in the Supplementary Material (Table S1). The technical assumptions concerning storage technologies (efficiency and power to energy ratio), fuels, and transmission grids can be found in the Supplementary Material (Tables S2-S4).

The weighted average cost of capital (WACC) is set to 7% in this study. However, for residential PV prosumers WACC is set to 4% due to lower financial return requirements. The cost recovery is mostly considered for a wider aggregate range of investors, which includes a mix of debt and equity financing. On this basis, the commercial and industrial investors require higher returns on equity margins than private investors. Therefore, WACC is split into two categories in this study. The WACC variation does not substantially alter the cost of the energy system (Breyer et al., 2017). Additionally, the risk profile of nuclear and coal is much higher than RE, which should result in a higher WACC level for nuclear energy and coal compared to RE technologies (Ram et al., 2018), however, these higher risks are not taken into account in the research.

The electricity prices for residential, commercial and industrial consumers for the year 2015 were retrieved from (Eskom, 2015). The electricity price was calculated until 2050 according to Gerlach et al. (2014) and Breyer and Gerlach (2013). The electricity prices during the transition are calculated according to the assumptions from Gerlach et al. (2014) that grid electricity prices rise by 5% per annum for <0.15 €/kWh, by 3% per annum for 0.15–0.30 €/kWh and by 1% per annum for >0.30 €/kWh. The electricity prices for South Africa are provided in the Supplementary Material (Table S5). An average currency exchange rate for a period of 5 years from 2013 to 2018 was considered, at 16.67 €/ZAR (equal to 0.06 ZAR/€).

The upper limits for all RE technologies were estimated according to Bogdanov and Breyer (2016) and lower limits are obtained from Farfan and Breyer (2017). Upper and lower limits of RE and fossil fuels are provided in the Supplementary Material (Tables S6 and S7). For all other technologies, upper limits are not specified. However, for solid biomass residues, biogas, and waste-to-energy plants it is assumed, due to energy efficiency reasons, that the available and specified amount of the fuel is used during the year.

2.4.2. Resource potential for renewable technologies

The feed-in profiles for solar PV optimally tilted and single-axis tracking ground-mounted power plants, wind energy and CSP are calculated according to Bogdanov and Breyer (2016) and Afanasyeva et al. (2018), based on resource data of NASA (Stackhouse and Whitlock, 2008; 2009), reprocessed by the German Aerospace Centre (Stetter, 2012). The obtained NASA dataset is in a temporal resolution of 3 h for the year 2005 and spatial resolution of 1° x 1°. An Enercon wind turbine (E-101) with a rated power of 3 MW and 150 m hub height is used to compute the wind feed-in profiles. The full load hours (FLH) feed-in profiles are calculated based on real weather conditions for the year 2005 on a 0.45° x 0.45° spatially and hourly temporally resolved data using a weighted average formula, this methodology is described in Bogdanov and Breyer (2016). It is assumed that 0-10% best areas are weighted by 0.3, 10-20% best areas

are weighted by 0.3, 20-30% best areas are weighted by 0.2, 30-40% best areas are weighted by 0.1 and 40-50% best areas are weighted by 0.1%. The hydropower feed-in profiles are computed based on the monthly resolved precipitation data for the year 2005 as a normalised sum of precipitation in the regions. Such an estimate leads to a good approximation of the annual generation of hydropower plants (Verzano, 2009). Full load hours of various resources are presented in the Supplementary Material (Tables S11-S13 and Figure S1) and visualised in an hourly resolution in Figure 5. Figure S1 shows the geographic diversity in wind and solar resources across the country.

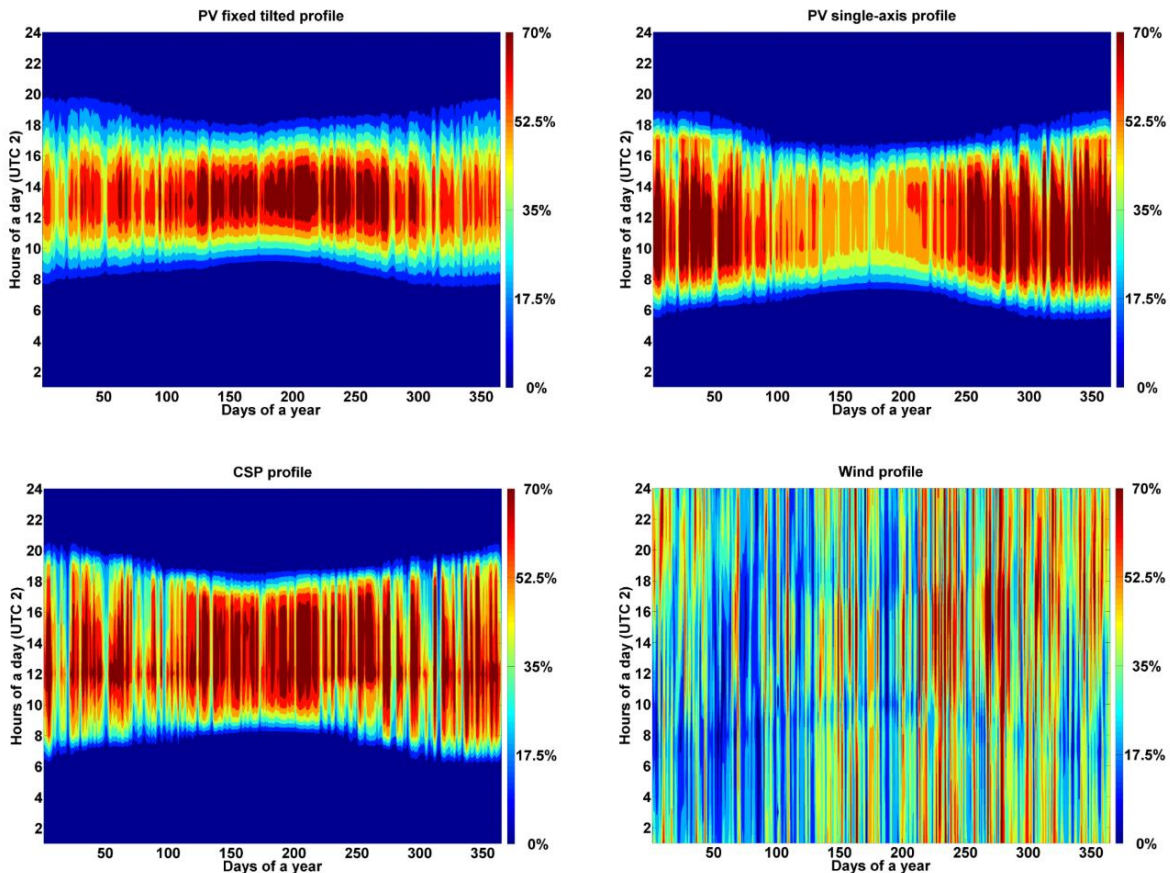

Figure 5. Aggregated feed-in profiles for optimally tilted (top left) and single-axis tracking PV (top right), CSP solar field (bottom left), and wind power plants (bottom right) in South Africa.

The potentials for biomass and waste resources are taken from German Biomass Research Centre (DBFZ, 2010) and are classified according to Bogdanov and Breyer (2016). The costs for biomass are calculated using data from the International Energy Agency (IEA, 2012) and Intergovernmental Panel on Climate Change (IPCC, 2011). For solid waste, a 50 €/ton gate fee was assumed for 2015, which increased up to 100 €/ton in 2050.

2.4.3. Electricity demand

The hourly electricity load profile is calculated as a fraction of the total demand for each sub-region based on synthetic load data weighted by the sub-regions population (Toktarova et al., 2018). Figure 6 shows the aggregated load curve and long-term electricity demand for South Africa. Electricity demand is taken from Wright et al. (2017). The population in South Africa is expected to grow from 54 million in 2015 to 66 million in 2050 (UN, 2015), while the average per capita electricity demand rises from 4.9 to 8.2 MWh as

shown in Figure 6 (right). The electricity demand until 2050 is provided in the Supplementary Material (Table S5).

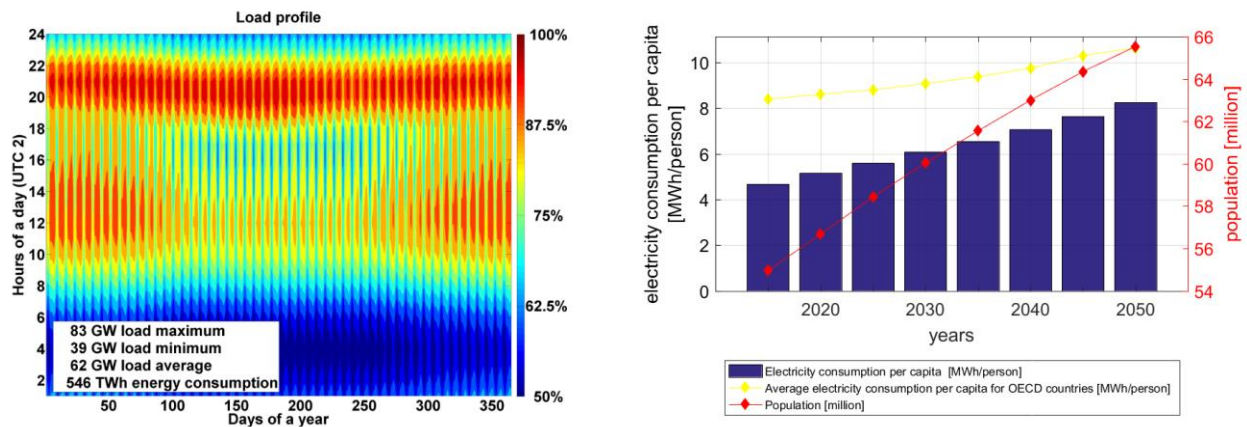

Figure 6. Aggregated load curve for South Africa for 2050 (left) and long-term demand from 2015 to 2050 (right).

2.4.4. Scenarios

In this study, five scenarios were studied for the South African energy transition analyses, which are briefly described in Table 2.

Table 2: Overview on scenarios

Scenario name	Description
Best Policy Scenario (BPS)	This scenario targets 100% RE by 2050. In addition, GHG emissions costs are considered and only electricity demand is covered. The Best Policy Scenario naming is considered on basis of 100% RE, zero GHG emissions, most job-rich and least-water intensive characteristics.
Best Policy Scenario no GHG emissions costs applied (BPSnoCC)	In this scenario, no GHG emissions costs are assumed.
Current Policy Scenario (CPS)	In this scenario, respective installed capacities according to the Integrated Resource Plan (IRP) from now until 2050 were taken into account, in modelling the South African energy transition in the mid-term future (Wright et al., 2017).
Current Policy Scenario no GHG emissions costs (CPSnoCC)	In this scenario, no GHG emissions costs are assumed. Thus, only the financial implications of this scenario are discussed.

3. Results

3.1. Analysis of financial outcome of the transition for all scenarios

The average financial results for the studied scenarios are expressed as levelised cost of electricity (LCOE), levelised cost of electricity for primary generation (LCOE primary), levelised cost of curtailment (LCOC), levelised cost of storage (LCOS), levelised cost of transmission (LCOT), levelised cost of import (LCOI), fuel costs and CO_{2eq} emission costs, as shown in Figure 7 from 2015 to 2050. The LCOE in the BPSs is observed as shown in Figure 7 (a-b). The LCOE increase until 2025, due to decommissioning of fossil

power plants and concurrent replacement with RE capacities. From 2025 onwards, the LCOE declines, as low-cost solar PV and wind energy dominate the system in the BPS. Whereas, the LCOE in the BPSnoCC increases until 2035 and gradually declines afterwards until 2050. By 2050, the LCOE obtained in the BPS is 50.8 €/MWh and 47.1 €/MWh in BPSnoCC, as shown in Figure 7 (a and b). The contrary trend is observed in the CPS, as the LCOE increases throughout the transition. By 2050, the LCOE obtained in the CPS is 104.9 €/MWh as shown in Figure 7c. Fuel and GHG emissions costs account for more than 50% of the LCOE in the CPS by 2050. Yet, the LCOE obtained in the CPS without GHG emissions costs (CPSnoCC) is 62.8 €/MWh as shown in Figure 7d, which is still higher in comparison to the LCOE obtained in the BPSs by 24% in 2050. Additional results on costs for all scenarios are available in the Supplementary Material (Table S14 and Figure S2-S4).

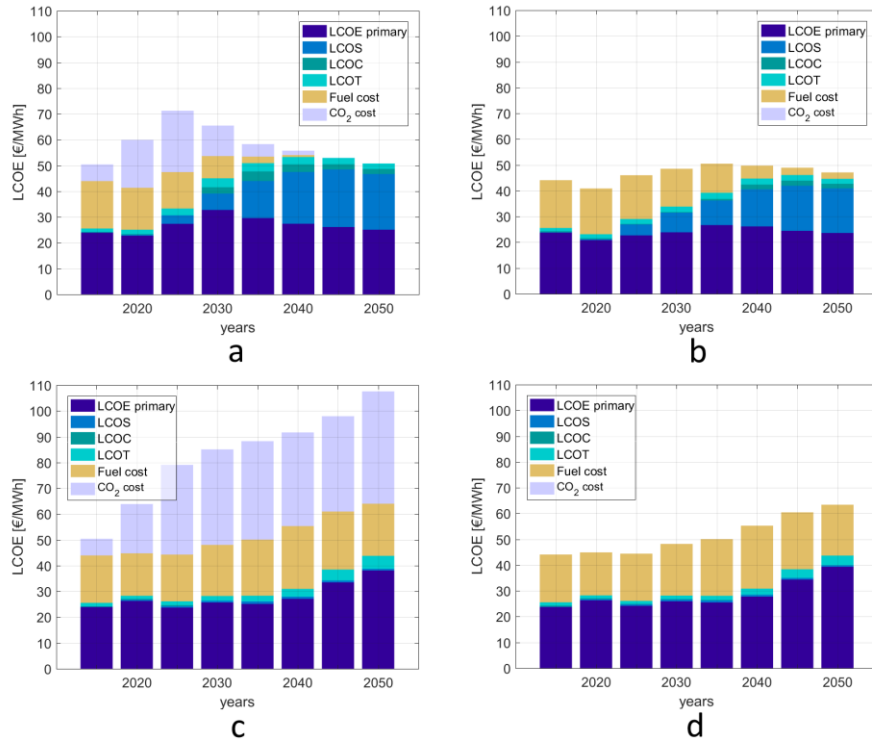

Figure 7. Levelised cost of electricity for BPS (a), BPSnoCC (b), CPS (c), and CPSnoCC (d).

3.2. Analysis of required installed capacities and electricity generation mix during the transition

The system architecture changes gradually as the fossil generators leave the system and are replaced by RE technologies, particularly in the BPSs. Figure 8 presents the installed capacities from 2015 until 2050 and absolute numbers are available in the Supplementary Material (Tables S8-S10) for all scenarios. By 2050, the total installed capacity is 321 GW, 295 GW and 134 GW in the BPS, BPSnoCC and CPS, respectively. In the BPSs, the solar PV and wind energy shares dominate the total installed capacity by 2050. The installed solar PV capacity is 241.7 GW, 233.4 GW and 15.8 GW in the BPS, BPSnoCC, and CPS respectively by 2050. While wind energy installed capacity is 51.2 GW, 36.8 GW and 30.4 GW in the BPS, BPSnoCC and CPS respectively by 2050. By 2050, the total installed capacity of thermal power plants is 26.6 GW, 23.8 GW and 81.3 GW in the BPS, BPSnoCC and CPS, respectively. The application of GHG emissions costs resulted in a fast and high penetration of RE installed capacities as observed in the BPS in comparison to BPSnoCC. The total capacity requirement in the BPSnoCC is low, due to the influence of

thermal plants operating on high FLH. Key power capacities required for the energy transition for South Africa are provided in the Supplementary Material (Tables S8-S10).

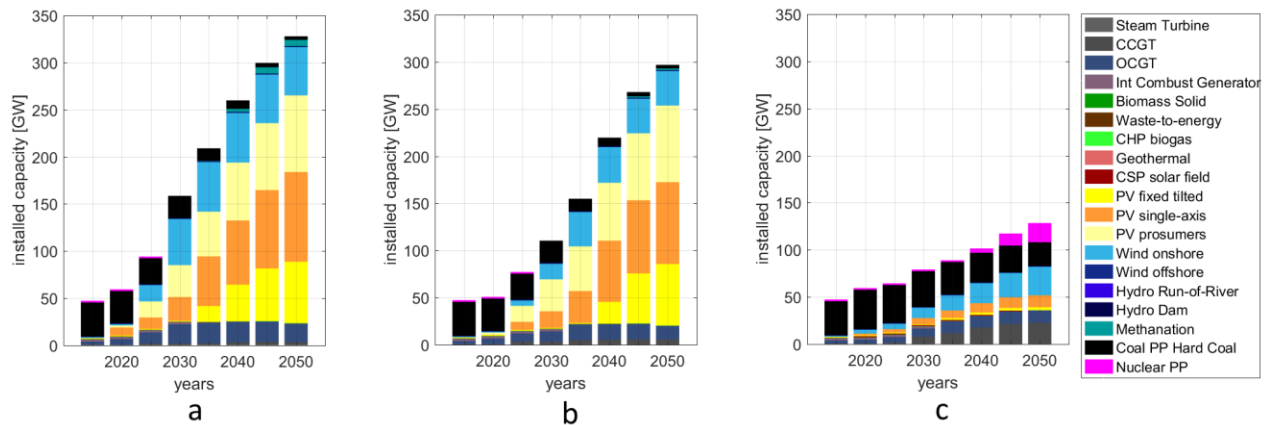

Figure 8. Installed generation capacities for BPS (a), BPSnoCC (b) and CPS (c) from 2015 to 2050.

Figure 9 depicts the electricity generation mix in all scenarios from 2015 to 2050. The coal-dependent power system can be substituted by a mix of solar PV and wind energy, complemented by hydropower and biomass as observed in BPS and BPSnoCC as shown in Figure 9 (a-b). The results of this research indicate that from 2035 onwards, solar PV and wind energy can drive the deep decarbonisation of the South African power system in the BPSs. By 2050, solar PV and wind energy contributes 459 TWh and 181 TWh in the BPS as shown in Figure 9a. Whereas, the solar PV and wind supply shares decrease to 441 TWh and 131 TWh respectively in the BPSnoCC as shown in Figure 9b, due to the influence of fossil power plants operating on higher FLH until 2050. Nevertheless, in the BPSnoCC the share of RE generation reaches 95.6% by 2050, which implies a high cost competitiveness of RE technologies, particularly solar PV and wind energy. Wind energy contribution remains constant from 2030 onwards, which is a consequence of the continued cost decline of solar PV and battery storage, also observed for the case of Turkey (Kilickaplan et al., 2017). Figure 9c shows the generation mix in the CPS. Coal, nuclear and wind energy dominate with 155 TWh, 152 TWh and 114 TWh of the total generation respectively by 2050. Coal-based electricity supply declines from 2030 onwards as the shares of RE capacities and gas turbines increase in the energy system, while nuclear energy contribution increases from 2040 onwards in the CPS. The share of electricity imports increases from 2030 onwards, as hydropower imports from Inga is considered according to the IRP (Wright et al., 2017). Additional graphical results of electricity generation by technology for all scenarios are presented in the Supplementary Material (Figure S5).

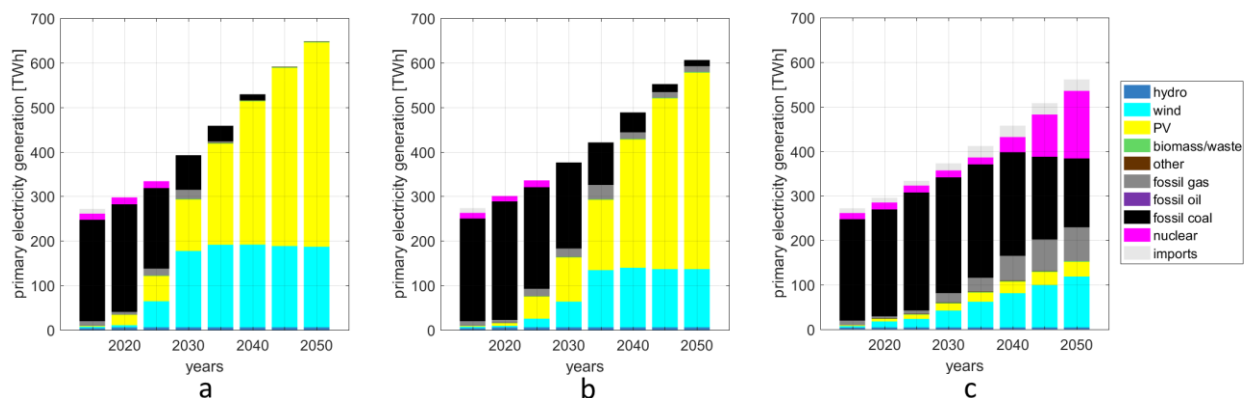

Figure 9. Electricity generation mix for BPS (a), BPSnoCC (b) and CPS (c) from 2015 to 2050.

3.3. Assessments of system flexibility during the transition for all scenarios

The flexibility of the power system due to a high share of variable renewable energy (VRE) and dynamic load is analysed in this section. The power system flexibility is analysed in context of storage requirement and utilisation, grid integration and the role of gas turbines for deep decarbonisation of coal-dependent South African power system.

3.3.1. Analysis of storage utilisation and required capacities during the transition

Storage capacity requirement and utilisation are crucial in the BPSs due to high penetration of RE in these scenarios. By 2050, the cumulative installed storage capacity is 16.3 TWh, 2.5 TWh and 0.01 TWh in the BPS, BPSnoCC and CPS, respectively. Gas storage dominates the total storage capacity in the Best Policy Scenarios by 2050. By 2050, gas storage contributes 15.7 TWh in BPS, 1.9 TWh in BPSnoCC and 0.008 TWh in CPS as shown in Figure 10. The high shares of gas storage in the BPSs are required to smoothen the synoptic and compensate the seasonal variation of RE resources. The shares of gas storage capacities increase from 2040 onwards in BPS, as the RE shares increase to about 80%. Gas storage includes the PtG technology, which allows production of SNG for the power system. The PtG option provides the system with the highest flexibility and integrates most of the excess electricity generated. The prosumer and utility-scale battery storage capacities increased from 2030 onwards in the BPSs. In the CPS, PHES provides the entire storage need for the year 2015 and contributes to the storage mix until 2050. TES dominates the storage mix from 2020 to 2045, due to CSP installed capacities. The heat generated through CSP and power-to-heat is stored in the TES. The gas storage capacity increases until 2030 and remains stable afterwards. The storage capacity in the CPS grows until 2035, and declines afterwards due to an increasing share of nuclear energy from 2040 onwards.

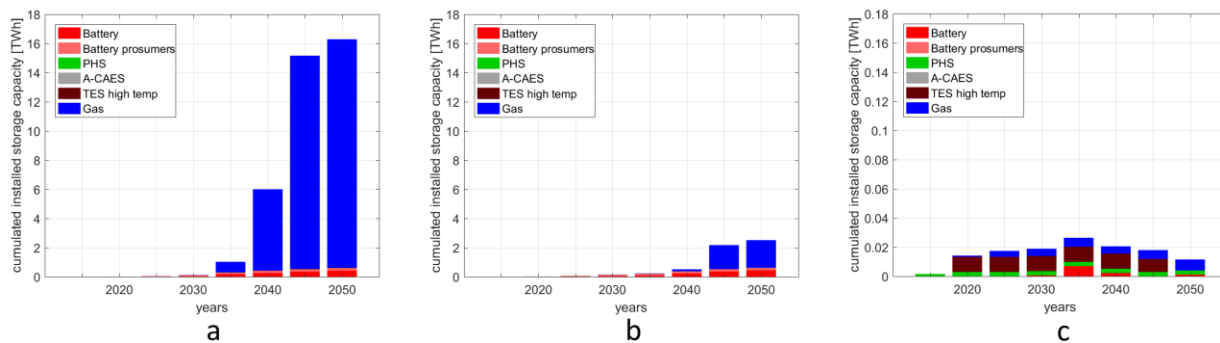

Figure 10. Cumulative installed capacities of storage technologies for BPS (a), BPSnoCC (b) and CPS (c) from 2015 to 2050.

Figure 11 shows the storage throughput during the transition and absolute numbers are presented in the Supplementary Material (Tables S15-S17). Battery storage dominates with respect to storage throughput during the transition in the BPS and BPSnoCC as shown in Figure 11 (a and b). Hybrid PV-battery systems evolve to a highly economic option for the energy system. The daily charge and discharge of batteries is needed due to high solar PV penetration in the system. Utility-scale and prosumer battery storage output shows huge relevance during the transition, while gas storage, TES and PHES complement depending on RE variability timescales in the system. Prosumer battery dominates in terms of output until 2030. In the CPS, PHES and TES dominate the system until 2030 as shown in Figure 11c. Nevertheless, storage capacity requirement and utilisation in terms of throughput is low in the CPS, due to the dominance of thermal power

plants. The storage requirement in terms of installed capacity and utilisation observed for all scenarios during the transition is found to be directly proportional to the level of RE penetration. More graphical results on the state of charge of storage technologies in all examined scenarios are available in Supplementary Material (Figures S6-S10).

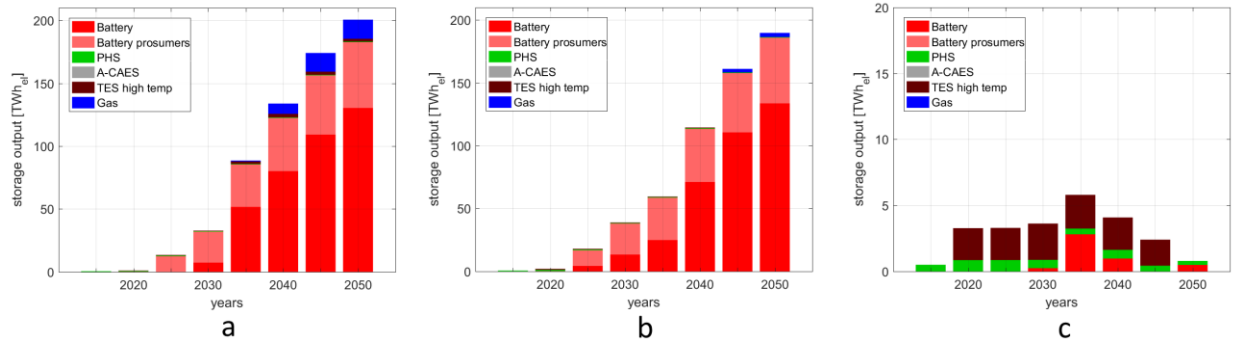

Figure 11. Cumulative storage output for BPS (a), BPSnoCC (b) and CPS (c) from 2015 to 2050.

Battery discharge to PtG is observed in the BPSs. This phenomenon (Battery-to-PtG effect (Gulagi et al., 2018)) is observed nearly throughout the years. During the night and early hours of the day when demand is low, energy stored in batteries is discharged to electrolyser units to produce gas, which is stored for long term. By 2050, battery-to-PtG discharge is around 12 TWh in each of the Best Policy Scenarios as part of the least cost solution, representing 2% of the electricity demand in 2050. Batteries discharging to PtG is observed from 2035 onwards, when RE share is around 80% in the BPSs.

3.3.2. Assessment of transmission grid utilisation during the transition

The level of grid utilisation varies from time to time in BPS and BPSnoCC, while it is constant in the CPS as shown in Figure 12. Grid utilisation in the BPS and BPSnoCC occurs mostly in the summer and spring periods, and reduces in autumn and winter times as shown in Figure 12 (a and b). The summer and spring periods, are the best seasons for solar and wind resource availability. During the autumn and winter periods, gas storage compensates the seasonal variation of RE resources. In the CPS, thermal power plants are site specific and require maximum grid utilisation in shifting energy across the country. The grid utilisation is intense during the daytime working hours and at night, but low in the early morning hours in the CPS. The net grid export between sub-regions ranges from 167 TWh to 197 TWh in the BPSs and 242 TWh in the CPS by 2050. This implies that sub-regions are more independent in producing their own electricity in the BPSs than in the CPS. In the BPS, it is observed that sub-regions with best RE resources are net exporters and others are net importers. The Northern Cape province is the main exporting region due to excellent RE resources and low demand. Figure 13 shows the direction and amount of electricity transmitted across the country. The thickness of the flow indicates the amount of electricity transferred between the regions in TWh. North Cape becomes the main exporting region by 2050 in a fully RE system in comparison to the current situation in which Mpumalanga province supplies almost the entire country's electricity demand due to huge power plants located in the province.

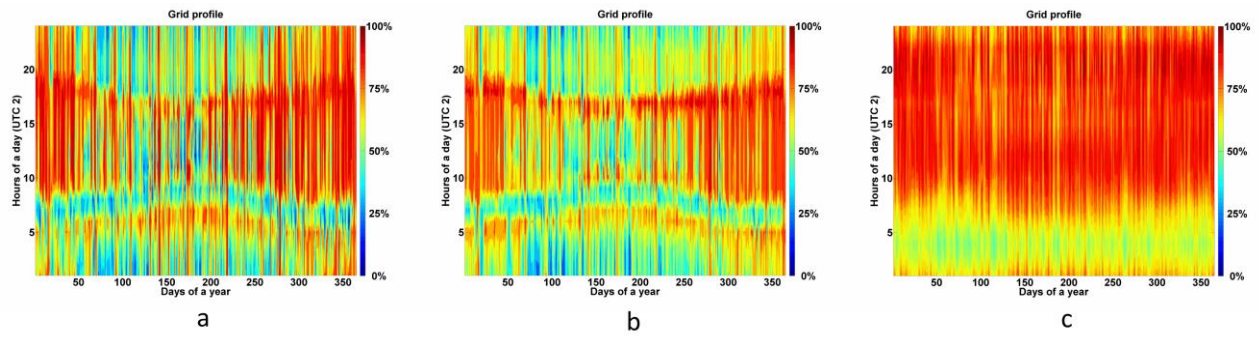

Figure 12. Grid profile for BPS (a), BPSnoCC (b) and CPS (c) for 2050. (Grid profile is the hourly distribution of electricity demand over the entire year)

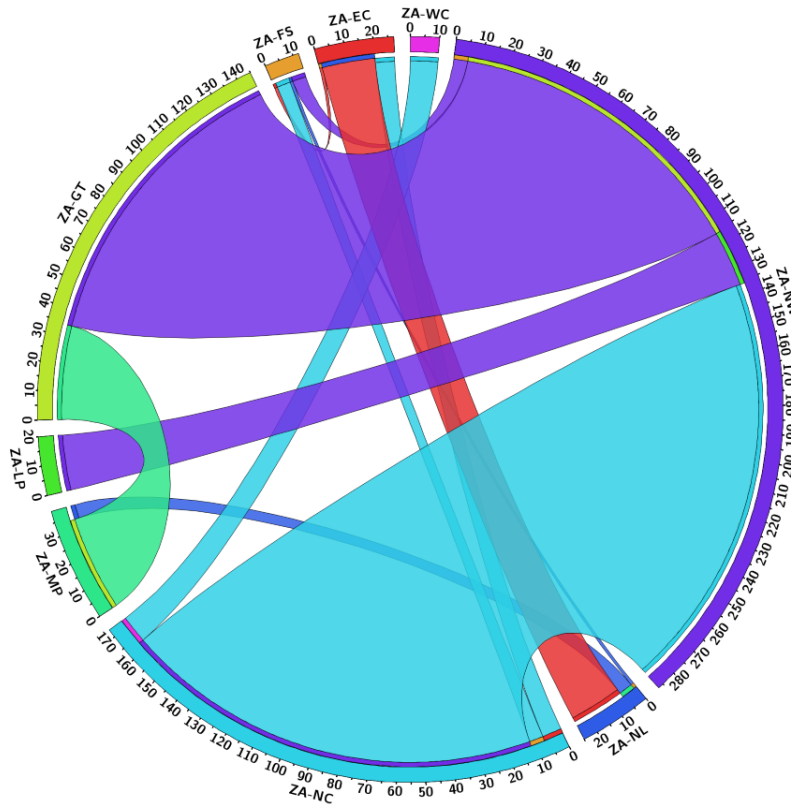

Figure 13. Electricity transmission between the sub-regions for 2050 in the BPS

3.3.3. Analysis of gas technology relevance during the transition in the Best Policy Scenarios

The gas turbines usage is observed during low RE resource availability, particularly in the winter period. By 2050, the capacity of gas turbines is 23 GW each in BPS and 20 GW in BPSnoCC. The average FLH of gas turbines decline from about 2600 hours in 2015 to 700 hours in BPS and to 800 hours in BPSnoCC by 2050. In addition, gas turbines are a relevant peaking technology because they are economically and technically more rampable to produce high amounts of power when required. By 2050, gas turbines generate approximately 16 TWh in the BPS and 17 TWh in BPSnoCC. Gas turbines are comprised by about

87% OCGT and 13% CCGT in the BPS as the least cost mix, with 482 FLH for OCGT and 2146 FLH for CCGT.

3.4. Analysis of sub-region optimised fully renewable system structure by 2050

This section presents the sub-regional installed capacity projection for a fully RE system in 2050 as shown in Figure 14. Solar PV dominates the share of total installed capacities, particularly solar PV single-axis tracking followed by PV prosumers. Solar PV single-axis tracking installed capacity is 95 GW in BPS, representing 39.4% of total solar PV capacity. While the installed capacity of PV prosumers is 81 GW in each of the scenarios. Solar PV installations are observed in all sub-regions due to even distribution of solar resources across the country. However, the highest share of installed solar PV capacity is found in the Northern Cape sub-region, due to excellent solar resource in this province. Solar PV emerges as the least cost option to meet electricity demand by 2050. Nevertheless, there are excellent wind sites in South Africa, particularly the Eastern Cape, Western Cape and Northern Cape. Beside solar PV, wind energy plays an important role in the transition. The total wind capacity is approximately 51 GW in BPS. Solar PV and wind energy drive most of the system in South Africa by 2050. Additional graphical results on sub-regional electricity generation, installed capacity, regional storage capacities and regional storage annual throughput in 2050 can be found in the Supplementary Material (Figures S11-S14).

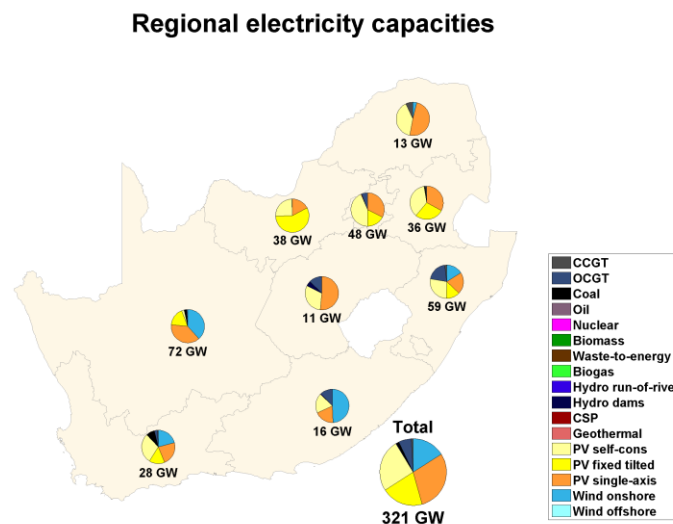

Figure 14. Installed generation capacities for BPS across the nine sub-regions of South Africa for 2050.

3.5. Analysis of GHG emissions under various transition scenarios

The GHG emissions trajectory during the transition for all scenarios is illustrated in Figure 15. The red curve shows the ratio of CO₂ emitted per kWh of electricity. The emissions trend in the BPSs is visualised as shown in Figure 15 (a and b). The emissions trend in BPS and BPSnoCC shows a similar pattern, as GHG emissions plateau by 2020 and decline afterwards in both scenarios. From 2025 onwards, emissions decrease substantially as coal-fired plants are replaced by RE capacities, mainly solar PV and wind energy in the BPSs. By 2050, a zero emissions system is achieved in the BPS. Deep decarbonisation of 75% to 71 MtCO_{2eq} in 2030 and 98% to 10.2 MtCO_{2eq} in 2040 as shown in Figure 15a for BPS. The BPSnoCC shows a slower reduction in GHG emissions and zero emissions is not reached by 2050. However, deep

decarbonisation of 70% to 89 Mt_{CO₂eq} in 2035 and 96% to 16 Mt_{CO₂eq} is still achieved for the BPSnoCC in 2050, as shown in Figure 15b. The GHG emissions trend in the CPS is visualised in Figure 15c. The annual GHG emissions reach its peak in 2030 and gradual decline afterwards as coal contribution in terms of capacity and generation declines in the system. In the CPS, GHG emissions decline from 214 Mt_{CO₂eq} in 2030 to 151 Mt_{CO₂eq} in 2050.

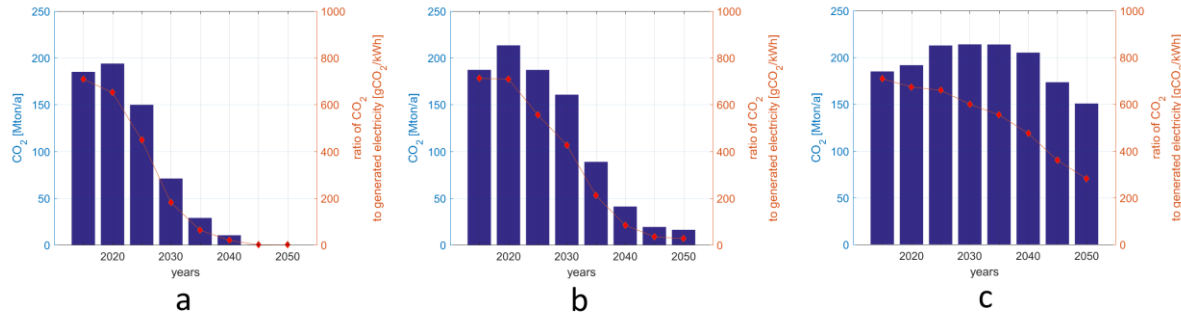

Figure 15. The total annual GHG emissions and ratio of GHG emissions to electricity generation during the transition for BPS (a), BPSnoCC (b) and CPS (c).

3.6. Water demand by power plants and job creation during the transition

3.6.1. Water demand of thermal power plants

Water withdrawal and water consumption of thermal power plants were calculated based on the water use intensity factors provided by Macknick et al. (2012) and using the methodology of Lohrmann et al. (2019). For the analysis, the subset of thermal power plants exceeding 50 MW was selected. This corresponds to 47.6 GW and accounts for 0.85% of the total thermal power generation capacity of South Africa. Figure 16 depicts the exact location of the active thermal power plants presented for the analysis.

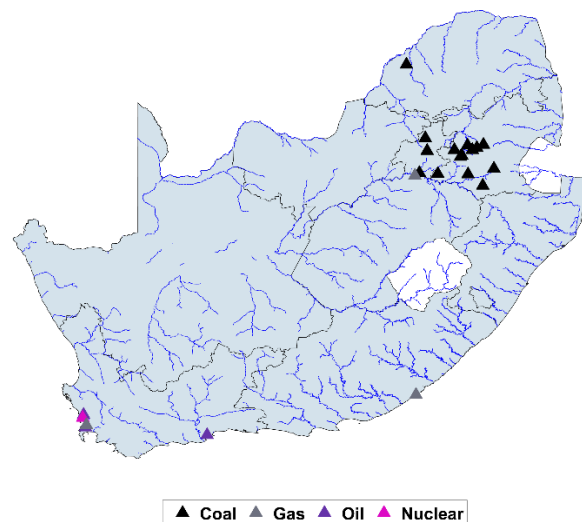

Figure 16. Active thermal power plants exceeding 50 MW, per fuel type.

In 2015, total water consumption (combined freshwater and saline water) for thermal generation was 0.346 km³, whereas total water withdrawal was 2.72 km³. From the perspective of freshwater extractions, 0.331

km³ of freshwater was consumed (96% of the total water consumption) and 0.399 km³ of freshwater was withdrawn (15% of the total water withdrawals). Currently, coal-based power plants account for 100% of the freshwater consumed. The ‘leader’ among regions in freshwater extractions is the Mpumalanga province constituting for 83% of all freshwater extractions for the power sector of South Africa.

The development of freshwater demand for both scenarios is illustrated in Figure 17. According to the BPS, both freshwater withdrawal and consumption are estimated to be reduced 87% by the year 2030, and 99% by 2050, respectively, compared to the 2015 level. In 2050, gas-fired power plants consume 0.0001 km³ of freshwater, which is expected to constitute for 100% of the country’s annual freshwater consumption related to the power sector. Opposed to that, the projections of the CPS show a decline of only 38% in freshwater extractions by 2050. In 2050, thermal power plants consume 0.196 km³ of freshwater, of which 99.7% is allocated for cooling of newly commissioned coal power plants. More information on the current water demand of thermal power plants and its’ projected development during 2015-2050 is available in Supplementary Material (Tables S18-S21 and Figures S15-S18).

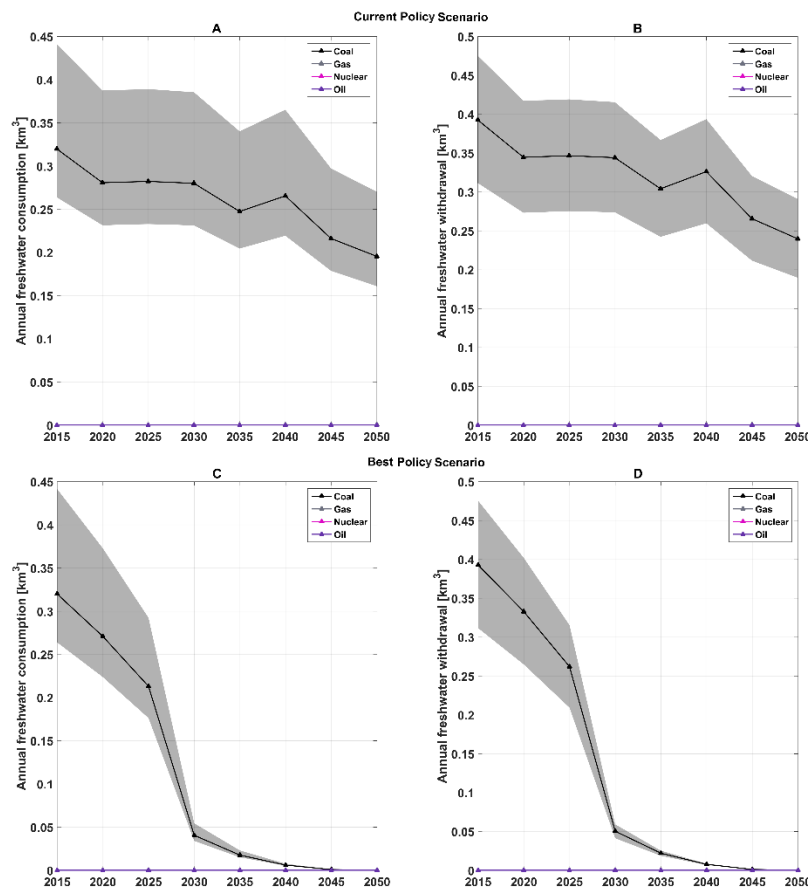

Figure 17. Development of freshwater consumption and freshwater withdrawal (median values and min-max interval): the CPS (a-b) and the BPS (c-d).

3.6.2 Job creation for the Current Policy Scenario and Best Policy Scenario

The annualised direct jobs created in the power sector during the energy transition for the BPS, as well as the CPS were estimated based on the methodology presented by Ram et al. (2017a, 2019) and the assumed employment generation factors can be found in the Supplementary Material (Table S22). Solar PV is observed to be the prime job creator through the transition period, with 67% of the total jobs created by 2050, in the case of BPS as depicted in Figure 17. Whereas, coal-based power generation creates the most jobs in the CPS, with 45% of the jobs by 2050 as indicated in Figure 18. Overall, number of direct energy jobs created in the BPS are seen to grow massively from around 210 thousand in 2015 to nearly 408 thousand by 2035, with the massive capacity additions propelled by higher growth rates. Beyond 2035, as growth rates stabilise, jobs created are observed to steadily reduce to over 278 thousand by 2050. On the other hand, jobs created in the CPS remain quite stable with a marginal decrease to around 184 thousand by 2050.

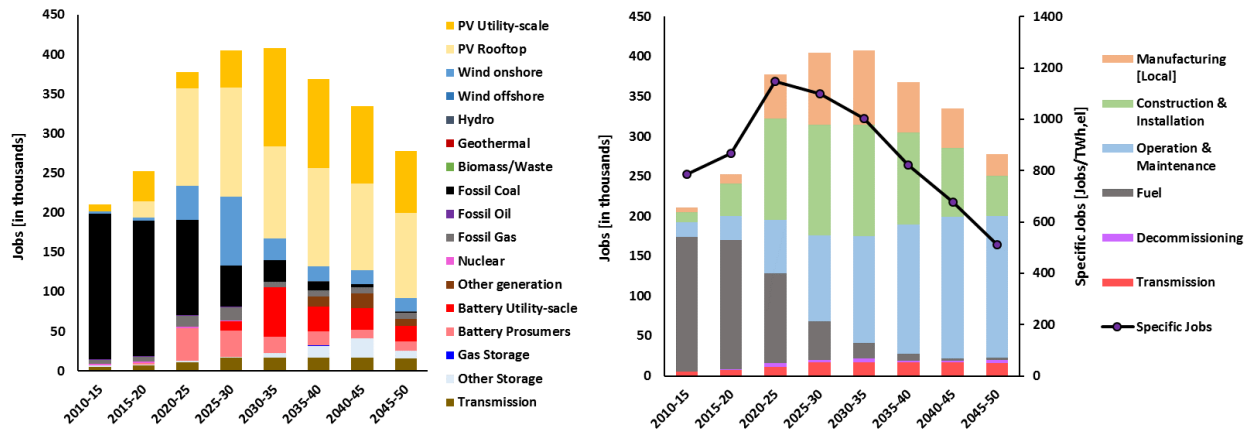

Figure 18. Jobs created by the various power generation and storage technologies (left) and jobs created based on different categories with the development of electricity demand specific jobs (right) during the energy transition from 2015 to 2050 in South Africa for the BPS.

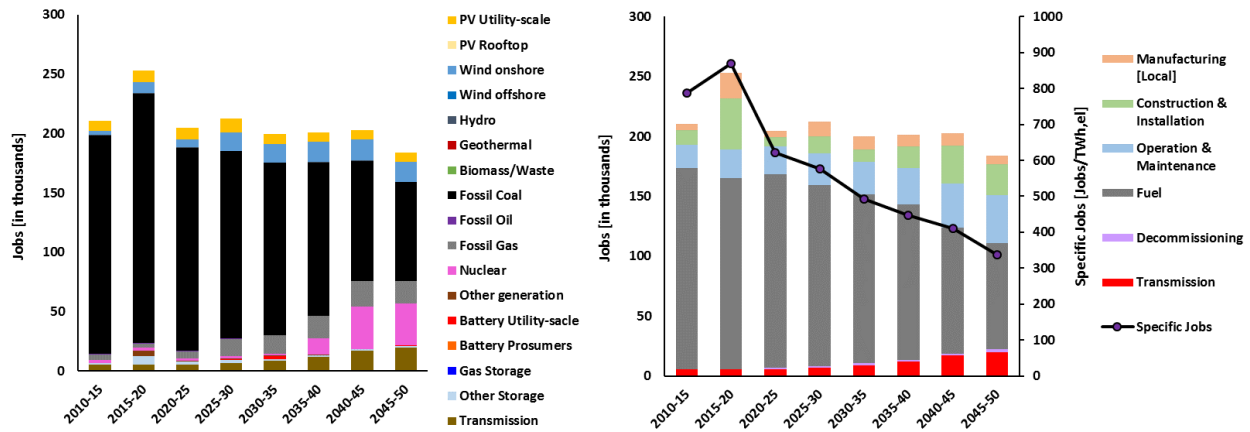

Figure 19. Jobs created by the various power generation and storage technologies (left) and jobs created based on different categories with the development of electricity demand specific jobs (right) during the energy transition from 2015 to 2050 in South Africa for the CPS.

Figures 18 and 19 also indicate the distribution of jobs across the different categories during the transition period in the BPS as well as CPS. In the case of BPS, with ramp up of installations up to 2035, bulk of the

jobs are created in the construction and installation of power generation technologies. The electricity demand specific jobs in the BPS increases substantially from 787 jobs/TWh_{el} in 2015 to 1148 jobs/TWh_{el} in 2025 with the rapid ramp up in RE installations. Beyond 2025, it stabilises around 1000 jobs/TWh_{el} and then declines steadily to around 511 jobs/TWh_{el} by 2050, as shown in Figure 17. Whereas, the electricity demand specific jobs in the case of CPS decline continually from 2020 onwards to 338 jobs/TWh_{el} by 2050, as indicated in Figure 19. The International Renewable Energy Agency (IRENA) estimated that the RE sector employed nearly 10 million people worldwide in 2016, with 62,000 jobs in Africa. Nearly half of these jobs are in South Africa and a quarter in North Africa (IRENA, 2017).

4. Discussion

Results of this research indicate that transition towards 100% RE-based system is achievable for South Africa. A 100% renewable based electricity is found to be the least cost option, consuming less water and creating more jobs than the current power system, which is mainly driven by coal-fired power plants. An addition scenario is presented in the Supplementary Material, which describes the integration of the desalination sector to the power sector (BPS-DES). Additional information on the electricity generation profile and energy flow diagrams are provided in the Supplementary Material (Figure S19-S24).

4.1 Analysis of key differences in Best Policy Scenarios and Current Policy Scenarios in 2050

This section compares the BPSs and the CPSs. Table 3 highlights the key differences in financial outcomes and selected electricity parameter for 2050. This research demonstrates that a fully decarbonised power system is the more cost optimal solution for South Africa by 2050. It reduces GHG emissions by 100% compared to the CPS. The total annualised cost of system in the CPS is 50% higher than in the BPS as show in Figure 20. Whereas, the total annualised cost of system obtained for 2050 in the CPSnoCC is 20% higher than in BPSnoCC as show in Figure 20. The total annualised cost of system required in CPSnoCC and BPSnoCC are relatively close until 2035, afterwards a disparity occurs as new investments in nuclear power plants are incurred in the CPSnoCC. Regarding capacity requirements, the BPSs are approximately 59% higher than required in the CPS. This is due to lower FLH of RE technologies, particularly solar PV and wind energy that dominate the power system in the BPS. While, the total generation in the BPSs are higher than the CPS by 16%, approximately. Results for the fully renewable end-point scenarios indicate that there is no need for high cost and high risk nuclear energy in the future South African electricity mix.

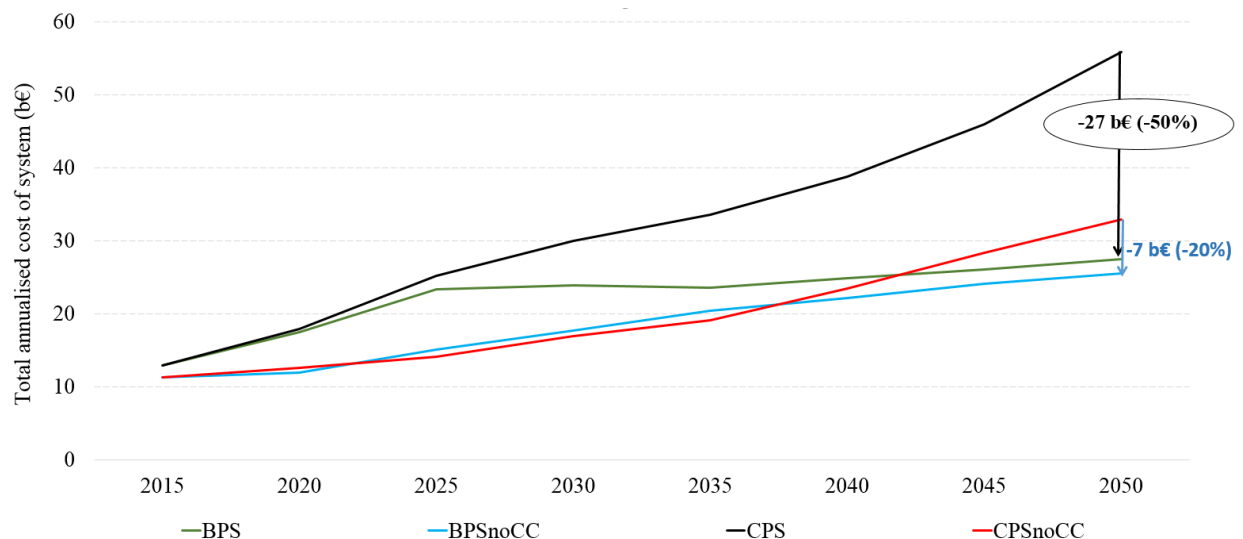

Figure 20. Comparison of total annualised cost of system for all scenarios in 2050.

Table 3: Difference in electricity parameters and financial outcomes in 2050 for all scenarios.

		unit	BPS	BPSnoCC	CPS	CPSnoCC
Financial outcome	Total annualised cost of system	[b€]	27.5	25.5	55.8	32.9
	Levelised cost of electricity	[€/MWh _{el}]	50.8	47.1	104.9	62.8
Electricity parameters	Demand	[TWh _{el}]	539.8	539.8	539.8	539.8
	Generation	[TWh _{el}]	648.1	606.2	561.1	561.1
	Installed capacity	[GW]	321.1	294.6	133.5	133.5

The LCOE obtained for the BPSs is comparable to Breyer et al. (2018), which shows a global range of 50-70 €/MWh. The annualised cost of system obtained for the year 2050 is 27.5 b€, 25.5 b€, 55.8 b€ and 32.9 b€ in the BPS, BPSnoCC, CPS and CPSnoCC, respectively. The financial outcomes of this research show that RE-based systems are economically feasible in South Africa. Most of the cost reduction can be attributed to low cost of solar PV, batteries and wind energy. In addition, RE has no fuel costs, which compensate for the entire system investments in the BPSs. Whereas, investments in fossil power plants in the CPSs might become a burden on the country's economy, as newly built coal or nuclear plants are likely to become stranded assets due to high relative cost, not only for the investment cost, but also the operation cost. In addition, the profitability of fossil fuel based technologies will be undercut by the increasing competitiveness of RE technologies (IEEFA, 2016). The 100% RE-based option for South Africa presented in this study is more cost competitive than the other alternative scenarios, which still have further disadvantages. South Africa is committed to reducing its GHG emissions, in pursuit of this goal, carbon capture and storage (CCS) is considered as part of its climate change mitigation strategy (Beck et al., 2013; Surridge et al., 2009). Energy system options, such as nuclear and fossil-CCS are not cost competitive (Breyer et al., 2018). According to Ram et al. (2017b; 2018), coal-CCS CAPEX are around 3891 €/kW in 2030, while the LCOE is around 105 €/MWh. For gas-CCS, the CAPEX ranges from 1934 €/kW to 2118 €/kW in 2030, the respective LCOE ranges from 94 €/MWh to 130 €/MWh. The LCOE assumed for new technologies in South Africa, shows that the tariffs in the year 2015 for solar PV and wind energy are 38% and 40% lower than LCOE for new baseload coal and nuclear (Wright et al., 2017). Furthermore, based on South Africa's decommission plan, another BPS scenario was simulated with coal and nuclear power plant decommissioning schedule set to 50 and 60 years, respectively. The result shows that by extending the coal and nuclear decommissioning schedule the power system will incur additional cost from 2030 onwards, until around 2045, in the range of 0.02 – 1.01 b€/a (0.1 – 3.9% of total annualised system cost).

The high costs observed in the CPS, is due to new investments in thermal power plants, in particular nuclear power plants from 2040 onwards. In fact, the relative cost difference may be higher in the CPS than the BPS, if capex assumptions for coal are considered according to IRP 2018 (DOE, 2018). Representatives from South Africa's largest utility mentioned, in early 2018, that nuclear would not be at the top of the agenda and South Africa simply could not afford nuclear (EWN, 2018). In addition, nuclear projects are susceptible to huge cost overruns (Sovacool et al., 2014). Moreover, new investment in coal power plants in South Africa should be carefully considered, as recently added coal-based power plants have already become stranded assets in several countries (Ram et al., 2017b; Farfan and Breyer, 2017; IEEFA, 2016). The results of the BPSs show that no new coal and nuclear will be required in the least-cost expansion.

Furthermore, nuclear energy violates all sustainability criteria that should form a framework for a resilient energy system design (Child et al., 2018).

4.2 Role of RE and storage technologies

The power system optimisation shows solar PV followed by wind energy drive the energy system in the BPS and BPSnoCC. The outstanding role of PV technologies needs to be highlighted in RE dominated scenarios for the case of South Africa. It is least-cost to supply 71% to 73% of electricity demand from solar PV alone. PV prosumers contribute 22% to the total electricity generation in 2050. Based on living standards measure 7 (LSM7) households and 5 kW household installations, embedded generation residential and commercial PV in South Africa could reach 22.5 GW by 2030 (Tuson, 2014). There are already developed regulations to guide the implementation of small-scale solar PV embedded generation in South Africa (Tuson, 2014). In addition, South Africa is recognised to have a huge solar potential, which is largely untapped. Barasa et al. (2018) reported on the impact of PV prosumers on a 100% RE system for Sub-Saharan Africa for 2030 cost assumptions and concluded that the total system cost increase slightly by 3.4-3.6%, while the electricity costs of the PV prosumers go down, whereas the peak load is reduced by 5.2%, which may lead to cost reductions beyond the scope of that study. PV prosumers installed capacity increases during the transition as the retail electricity prices increase. The growth is propelled by continuous decline in PV battery capex anticipated during the transition. The PV prosumers appear to be an important enabler of the transition. A study estimates the utility-scale solar PV projects to be equivalent to 220 GW using existing environmental impact assessment, while a conservative estimation for rooftop solar PV showed a potential capacity of 72 GW (Knorr et al., 2016). Both the rooftop and utility-scale solar PV showed a conservative potential of about 292 GW. The plausible reason for a high solar PV penetration is due to excellent resource conditions, low seasonal variation unlike other countries where solar PV supply drops in winter months and continuous cost decline of PV (Bischof-Niemz and Creamer, 2018; Breyer et al., 2018). Wind energy is expected to supply 22% to 28% to the total generation in 2050. However, wind energy contribution remains constant from 2030 onwards, due to further costs decline of solar PV and battery storage. In addition, if the wind capex would decline faster, a higher share of wind power generation could be expected. South Africa has the solar, wind and land resources to technically host a power system led by a mix of RE technologies (Bischof-Niemz and Creamer, 2018). The specific capacity density limited in the LUT Energy System Transition model is 75 MW/km² for optimally tilted PV and 8.4 MW/km² for onshore wind (Bogdanov and Breyer, 2016). Hence, an area of 3260 and 6180 km² is needed for solar PV and wind capacities in 2050 representing just 0.3% and 0.5% of the total land area of South Africa. The results of this study show that solar PV and wind energy will emerge as the backbone of a fully RE-based power system in South Africa, which is comparable to the findings of Barasa et al. (2018) for entire Sub-Saharan Africa (SSA) based on an overnight scenario approach for 2030. They conclude that SSA countries can be powered mainly by solar PV and wind energy. The Greenpeace Advance Energy [R]evolution scenario (Greenpeace, 2011a), projects higher annual RE growth rates, thus achieving a renewable electricity share of 94% and RE installed capacity of 114 GW by 2050. According to Greenpeace (2011a), solar PV dominates the installed capacity with 40 GW (35%), followed by CSP with 35 GW (31%), and wind energy with 27 GW (24%) by 2050. However, in the generation mix CSP dominates with 259 TWh (54%), complemented by solar PV with 79 TWh (16%) and wind energy with 68 TWh (14%) (Greenpeace, 2011a). The Council of Scientific and Industrial Research (CSIR) demonstrates that solar PV, wind and flexible power generators are the cheapest energy mix for South African power system (Wright et al., 2017). The study demonstrates a least cost option for the South African power system with over 70% of RE

penetration by 2050, which uses less water and provides a higher number of job opportunities (Wright et al., 2017). According to Wright et al. (2017), solar PV and wind energy dominate the total installed capacity with 140 GW (45%) and 73 GW (23%), while electricity supplied by solar PV is 213 TWh (36%) and wind is 223 TWh (38%), whereas no CSP generation is expected. The results of the BPSs in this study are comparable to the findings of Wright et al. (2017; 2019). In the CPS, fossil power plants dominate the power system accounting for 72% (383 TWh) of the total electricity generation in 2050. Among the RE technologies, wind energy emerges as a relevant resource in the CPS by 2050, which contributes 114 TWh (21%) of the total electricity generation by 2050. Upon the completion of Inga 3, 2.5 GW of the capacity is expected to be supplied by hydropower transmitted to South Africa. Electricity imports increase from 2030 onwards, in the CPS due to imports from Inga 3. The major risks associated with relying on hydropower imports are delays in the construction of the necessary grid extension as well as the hydropower plant (DOE, 2018). Oyewo et al. (2018) conclude that South Africa and other neighbouring countries can benefit from the Inga hydropower development. While the host country may bear most of the economic burden, not to mention the environmental risks. Results of the BPSs indicate that South Africa could independently meet its electricity demand without any electricity imports.

The results of this research reveal the significant role of PtG for handling high shares of RE, as discussed in (Gulagi et al., 2018; Ram et al., 2017a; Pleßmann et al., 2014; De Boer et al., 2014). The significance of battery storage is noticed from 2025 onwards, particularly in the BPSs. Regarding storage outputs, battery storage dominates due to daily requirements. By 2050, battery total output is 183 TWh (92% of total storage output) and 186 TWh (92%) in BPS and BPSnoCC, respectively. The role of prosumers and utility-scale batteries increased significantly from 2030 onwards. PV-battery hybrid systems emerge as the least cost option in a fully optimised RE system. Further cost reduction of batteries is expected (Schmidt et al., 2017; Kittner et al., 2017), which will increase PV growth (Breyer et al., 2018). Storage requirement is low in the CPS due to the dominance of thermal power plants that run on high FLH. Grid utilisation is very high in the beginning and towards the end of the year, particularly due to balancing demand in power deficit sub-regions in the BPSs. In the CPS, power plants are site specific and transmission grids are frequently utilised to supply electricity across the country. This clearly indicates the advantage of a distributed power system observed in the BPSs, as each region could produce its own electricity and import only when needed. The role of dispatchable gas technology is observed in the BPSs, as it is required to maintain balance between demand and supply in the power system. The role of gas turbines in a fully RE system is discussed in (Greenpeace, 2011a). According to Greenpeace (2011a), gas turbines installed capacity is 10 GW and generation is 16 TWh. Similarly in the CPS, gas technologies respond in times of high demand. A recent study on energy transition in South Africa concludes that a power grid with high RE penetration, in particular solar PV and wind energy requires flexibility that could be provided by using flexible natural gas fired turbines, if the costs of battery do not decrease (Klein et al., 2018).

4.3 Benefits of 100% RE

Examining the application of a GHG emissions cost during the transition, especially in the BPSs results in a rapid transition and fast GHG emissions reduction in comparison to no GHG emissions cost scenarios. However, the no GHG emissions cost scenarios achieved comparable results in terms of capacity, generation, cost of electricity and GHG emissions trajectory to the BPSs. By 2050, the RE electricity generation reaches 95.6% (579 TWh) in the no GHG emissions cost scenario, while the remaining 4.4% (26.9 TWh) is supplied by coal and gas turbines. The BPSnoCC is about 17% lower in total costs than the BPS, but 7% lower in costs than the CPSnoCC and 42% lower in total GHG emissions for the period 2015

to 2050. This indicates that the South African energy transition is achievable without GHG emissions cost implementation, if least cost options are chosen.

This study presents a pathway to a fossil carbon-free economy for South Africa on an hourly basis in 5-year intervals, which makes this study unique and a first of its kind. From an energy security perspective (Azzuni and Breyer, 2018), analysis of this research reveals that South Africa could achieve a secure power supply without imports. RE development in the country will foster socio-economic development, the results show that the BPS could boost employment prospects in South Africa. The direct energy jobs created in the BPS are seen to grow massively from around 210 thousand in 2015 to nearly 408 thousand by 2035, with the massive capacity additions propelled by higher growth rates. Beyond 2035, as growth rates stabilise jobs created are observed to steadily reduce to over 278 thousand by 2050. Whereas, jobs created in the CPS remain quite stable with a marginal decrease to around 184 thousand by 2050.

The findings of this research align with the perspectives of a recent review on the feasibility of 100% RE systems (Brown et al., 2018). Results of this research clearly show that a fully decarbonised South African power system can be achieved between 2040 and 2050. Deep decarbonisation of South Africa's energy system is technically and economically feasible by 2050. Owing to the low-cost electricity driven by solar PV and wind, South Africa can progressively pursue an electrification-of-almost-everything strategy by coupling the low-cost renewables-led electricity generation to the transport and heat sectors (Bischof-Niemz and Creamer, 2018). This research presents a detailed transition pathway towards a least cost and fully decarbonised power system by 2050, which complies with the Paris Agreement target of limiting temperature rise to 1.5 – 2 °C compared to the pre-industrial age.

5. Conclusion

The modelling outcomes reveal that a fully RE-based system is cost competitive and reliable as observed in the BPSs in comparison to the CPSs. The total system LCOE obtained in the BPSs ranged from 47.1 €/MWh to 50.8 €/MWh and from 62.8 €/MWh to 104.9 €/MWh in the CPSs by 2050. Much of the cost savings can be characterised by realistic ongoing cost decrease of RE technologies expected during the transition, especially high competitiveness of solar PV-battery hybrid systems and wind energy. Solar PV and wind dominate all the BPSs by 2050, solar PV contributes the most (75-79%) and wind energy (11-16%) to the total installed capacities, and (71-73%) and (22-28%) to the total electricity generation, respectively.

Storage technologies, transmission grids and gas power plants provide the required flexibility in a fully RE-based power system. The huge share of solar PV in electricity generation leads to a corresponding share of battery storage due to daily requirements. Gas storage becomes prominent when the RE share reaches 80% around 2035 in the BPS, balancing seasonal variation of wind and solar PV in the system. The existing coal and nuclear plants are expected to be phased out based on their lifetimes. However, new investments in coal and nuclear power plants may become stranded assets, which may be permanently subsidised. In addition, they stand the risk of cost overruns as in the case of Medupi and Kusile coal-fired power projects. Introducing GHG emissions cost would result in a rapid energy transition. Zero GHG emissions energy system is achieved in the BPS by 2050, when the GHG emissions cost is considered. Although, a similar emissions trajectory is observed in the BPSnoCC, but zero GHG emissions could not be achieved by 2050. The results of the BPS without GHG emissions cost indicate that RE electricity generation can reach 95.6%, while coal and gas turbines cover the remaining 4.4% by 2050

Energy policy in South Africa should place solar PV and wind energy at its core. It is clear that these technologies are set to play an active role in South Africa's future energy system as they are the least cost options for electricity supply. A 100% RE-based system is achievable and a real policy option for South Africa. The results of this research clearly show that a fully renewable power system consumes less water and creates more jobs than a fossil dominated system. South Africa's electricity demand can be met sustainably with the country's abundant renewable resources particularly solar and wind. Solar PV-battery hybrid systems and wind energy drive most of the system from 2030 onwards in a fully RE-based system. Further research has to be conducted incorporating additional energy sectors, i.e. transport, heat and industry, for a wider analysis of the South African energy transition in the mid-term future.

Acknowledgements

The authors gratefully recognise the governmental financing of Tekes (Finnish Funding Agency for Innovation) for the 'Neo-Carbon Energy' projects under the number 40101/14. Ayobami Solomon Oyewo would like to thank LUT Foundation for the valuable scholarship. The authors thank Tobias Bischof-Niemz for his valuable advice, which helped in further improving this research paper.

Supplementary Materials: The following are available online at:

Reference

- Afanasyeva, S., Bogdanov, D., Breyer, Ch., 2018. Relevance of PV with Single-Axis Tracking for Energy Scenarios. *Solar Energy* 173,173–191.
- Alton, T., Arndt, C., Davies, R., Hartley, F., Makrelov, K., Thurlowc, J., Ubogu, D., 2014. Introducing carbon taxes in South Africa. *Applied Energy* 116, 344–354.
- Azzuni, A., Breyer, Ch., 2018. Dimensions and Definitions of Energy Security: A Literature Review, *Wiley Interdisciplinary Reviews: Energy and Environment* 7:e268.
- Baker, L., Newell, P., Phillip, J., 2014. The Political Economy of Energy Transitions: The Case of South Africa. *New Political Economy* 9(6), 791–818.
- Baker, L., Sovacool, B.K., 2017. The political economy of technological capabilities and global production networks in South Africa's wind and solar photovoltaic (PV) industries. *Political Geography* 60, 1-12.
- Barasa, M., Bogdanov, D., Oyewo, A.S., Breyer, Ch., 2018. A cost optimal resolution for Sub-Saharan Africa powered by 100% renewables in 2030. *Renewable and Sustainable Energy Reviews* 92, 440-457.
- Beck, B., SurrIDGE, T., Hietkamp, S., 2013. The South African Centre for Carbon Capture and Storage Delivering CCS in the developing world. *Energy Procedia* 37, 6502-6507.
- Bogdanov, D., Breyer, Ch., 2016. North-East Asian Super Grid for 100% Renewable Energy supply: Optimal mix of energy technologies for electricity, gas and heat supply options, *Energy Conversion and Management* 112,176-190.
- Bogdanov D., Farfan J., Sadovskaia K., Aghahosseini A., Child M., Gulagi A., Oyewo S., Barbosa L.S.N.S., Breyer Ch., 2019. Radical transformation pathway towards sustainable electricity via evolutionary steps, *Nature Communications*, 10, 1077.

Bischof-Niemz, T., Creamer, T. 2018. South Africa's Energy Transition: A Roadmap to a Decarbonised, Low-cost and Job-rich Future. London: Routledge.

Breyer, Ch., Gerlach, A., 2013. Global overview on grid-parity. Progress in Photovoltaics: Research and Applications 21,121–136.

Breyer, Ch., Bogdanov, D., Gulagi, A., Aghahosseini, A., Barbosa L.S.N.S., Koskinen, O. et al. 2017. On the role of solar photovoltaics in global energy transition scenarios, Progress in Photovoltaics: Research and Applications, 25, 727–745.

Breyer, Ch., Bogdanov, D., Aghahosseini, A., Gulagi, A., Child, M., Oyewo, A.S., Farfan, J., Sadovskaia, K., Vainikka, P., 2018. Solar Photovoltaics Demand for the Global Energy Transition in the Power Sector, Progress in Photovoltaics: Research and Applications, 26, 505-523.

Brown, T.W., Bischof-Niemz, T., Blok, K., Breyer, Ch., Lund, H., Mathiesen, B.V., 2018. Response to 'Burden of proof: A comprehensive review of the feasibility of 100% renewable-electricity systems. Renewable and Sustainable Energy Reviews 92, 834–847.

Child, M., Koskinen, O., Linnanen, L., Breyer, Ch., 2018. Sustainability guardrails for energy scenarios of the global energy transition. Renewable and Sustainable Energy Reviews 91, 321–334.

Delina, L.L., Sovacool, B.K., 2018. Of temporality and plurality: an epistemic and governance agenda for accelerating just transitions for energy access and sustainable development. Current Opinion in Environmental Sustainability, 34, 1–6.

DBFZ, 2010. Deutsches Biomasse Forschungs Zentrum Endbericht Globale und regionale räumliche Verteilung von Biomassepotenzialen. (D. Thrän, K. Bunzel, U. Seyfert, V. Zeller, K. Müller, B. Matzdorf, H. Weimar, Eds.). 04347 Leipzig. [in German];
http://literatur.ti.bund.de/digbib_extern/dn047244.pdf

[DOE] - Department of Energy, 2015. State of renewable energy in South Africa., Pretoria.
http://www.gov.za/sites/www.gov.za/files/State%20of%20Renewable%20Energy%20in%20South%20Africa_s.pdf

[DOE] - Department of Energy. Integrated Resource Plan 2018. Pretoria; 2018.
<http://www.energy.gov.za/IRP/irp-update-draft-report2018/IRP-Update-2018-Draft-for-Comments.pdf>

[DEA] - Department of Environmental Affairs, 2015. South Africa's Intended Nationally Determined Contribution (INDC), Pretoria.
https://www.environment.gov.za/sites/default/files/docs/sanational_determinedcontribution.pdf

De Boer, H.S., Grond, L., Moll, H., Benders, R., 2014. The application of Power-to-Gas, pumped hydro storage and compressed air energy storage in an electricity system at different wind power penetration levels. Energy 72, 360-370.

Eskom Holdings, 2015. Tariff and Charges Booklets 2014/2015, Johannesburg.
<http://www.eskom.co.za/CustomerCare/TariffsAndCharges/Documents/TariffBrochureV9.pdf>

[EWN] – Eyewitness News, 2018. Nuclear power not at the top of ESKOM's agenda, says CFO Cassim, EWN, Johannesburg and Cape Town. <http://ewn.co.za/2018/01/30/nuclear-not-at-the-top-of-eskom-s-agenda-says-cfo-cassim>

Farfan, J., Breyer, Ch., 2017. Structural changes of global power generation capacity towards sustainability and the risk of stranded investments supported by a sustainability indicator. *Journal of Cleaner Production* 141, 370-84.

Gerlach, A., Breyer, Ch., Werner, C., 2014. Impact of financing cost on global grid-parity dynamics till 2030, 29th European Photovoltaic Solar Energy Conference, Amsterdam. September 22-26
<https://goo.gl/dv75Py>

Greenpeace Africa, 2011a. The advance energy [r]evolution: A sustainable energy outlook for South Africa, Johannesburg.
<http://citeseerx.ist.psu.edu/viewdoc/download?doi=10.1.1.364.8791&rep=rep1&type=pdf>

Grubler, A., 2012. Energy transitions research: Insights and cautionary tales. *Energy Policy* 50, 8 – 16.

Gulagi, A., Bogdanov, D., Breyer, Ch., 2018. The Role of Storage Technologies in Energy Transition Pathways Towards Achieving a Fully Sustainable Energy System for India. *Journal on Energy Storage* 17, 525-539.

[IEA] - International Energy Agency, 2012. Technology roadmap – bioenergy for heat and power. Paris, IEA Publications.

[IEA] - International Energy Agency, 2014. Africa Energy Outlook. A Focus on the Energy Prospects in Sub-Saharan Africa, Paris.
www.iea.org/publications/freepublications/publication/WEO2014_AfricaEnergyOutlook.pdf

[IEA] - International Energy Agency. 2015. Energy Efficiency Outlook for South Africa – Sizing up the opportunity, Paris.
<https://www.iea.org/publications/freepublications/publication/EnergyEfficiencyPotentialinSouthAfrica.pdf>

[IEEFA] - Institute for Energy Economics and Financial Analysis, 2016. Growing Risk of Stranded Energy Assets in South Africa. <http://ieefa.org/growing-risk-stranded-energy-assets-south-africa/>

[IPCC] - Intergovernmental Panel on Climate Change, 2011. Special report on RE sources and CC mitigation. Intergovernmental panel on climate change, Geneva.
www.ipcc.ch/pdf/specialreports/srren/SRREN_FD_SPM_final.pdf

[IRENA] - International Renewable Energy Agency, 2013. Southern African Power Pool: Planning and Prospects for Renewable Energy, Abu Dhabi. <http://www.irena.org/-/media/Files/IRENA/Agency/Publication/2013/SAPP.pdf>

[IRENA] - International Renewable Energy Agency, 2017. Renewable Energy and Jobs – Annual Review 2017, Abu Dhabi.

Kilickaplan, A., Bogdanov, D., Peker, O., Caldera, U., Aghahosseini, A., Breyer, Ch., 2017. An Energy Transition Pathway for Turkey to Achieve 100% Renewable Energy Powered Electricity, Desalination and Non-energetic Industrial Gas Demand Sectors by 2050. *Solar Energy* 158, 218-235.

Kittner, N., Lill, F., Kammen, D.M., 2017. Energy storage deployment and innovation for the clean energy transition. *Nature Energy* 2, 17125.

- Klausbrucker, C., Annegarn, H., Henneman, R.F., Rafaj, P., 2016. A policy review of synergies and trade-offs in South African climate change mitigation and air pollution control strategies. *Environmental Science and Policy* 57, 70–78.
- Klein, P., Carter Brown, C., Wright, J.G., Calitz, J.R., 2018. Energy storage and sector coupling for high renewable power generation scenarios for South Africa. Council for Scientific and Industrial Research & Energy Centre, Pretoria. <https://bit.ly/2tyJJa0>
- Knorr, K., Zimmermann, B., Bofinger, S., Gerlach, A., Bischof-Niemz, T., Mushwana, C., 2016. Wind and solar PV resource aggregation study for South Africa. Study by Fraunhofer IWES, Sanedi, Eskom, and CSIR, Germany, South Africa, Retrieved from <https://bit.ly/2WuBJUw>
- Lohrmann, A., Farfan, J., Caldera, U., Breyer, Ch., 2019. Overcoming water demand for cooling of thermal power plants while enabling global-local water and energy security with high shares of renewable energy. Submitted for publication.
- Macknick, J., Newmark, R., Heath, G., Hallett, K. C., 2012. Operational water consumption and withdrawal factors for electricity generating technologies: A review of existing literature. *Environ. Res. Lett.* 7.
- Menyah, k., Wolde-Rufael Y., 2010. Energy consumption, pollutant emissions and economic growth in South Africa. *Energy Economics* 32, 1374–1382.
- Mosek ApS, 2017. MOSEK version 8, Copenhagen, Denmark. <https://www.mosek.com/downloads/>
- Oyewo, A.S., Farfan, J., Peltoniemi, P., Breyer, Ch., 2018. Repercussion of large-scale hydro dam development: The case of Congo grand Inga hydro project. *Energies* 11, 972.
- Pleißmann, G., Erdmann, M., Hlusiak, M., Breyer, Ch., 2014. Global Energy Storage Demand for a 100% Renewable Electricity Supply. *Energy Procedia* 46, 22-31.
- Ram, M., Bogdanov, D., Aghahosseini, A., Oyewo, A.S., Gulagi, A., Child, M., et al. 2017a. Global Energy System Based on 100% Renewable Energy - Power Sector. Study by Lappeenranta University of Technology and Energy Watch Group, Lappeenranta, Berlin, Retrieved from: <https://goo.gl/NjDbck>
- Ram, M., Child, M., Aghahosseini, A., Bogdanov, D., Poleva, A., Breyer, Ch., 2017b. Comparing electricity production costs of renewables to fossil and nuclear power plants in G20 countries. Study by Lappeenranta University of Technology and Greenpeace, Amsterdam. <https://bit.ly/2qyuQ71>
- Ram, M., Child, M., Aghahosseini, A., Bogdanov, D., Lohrmann, A., Breyer, Ch., 2018. A comparative analysis of electricity generation costs from renewable, fossil fuel and nuclear sources in G20 countries for the period 2015-2030. *Journal of Cleaner Production* 199, 687-704.
- Ram, M., Aghahosseini, A., Breyer, Ch., 2019. Job creation during the global energy transition towards 100% renewable power system by 2050, *Technological Forecasting and Societal Change*, in press, DOI: 10.1016/j.techfore.2019.06.008.
- Schmidt, O., Hawkes, A., Gambhir, A., Staffell, I., 2017. The future cost of electrical energy storage based on experience rates. *Nature Energy* 2, 17110.
- Sovacool, B. K., Gilberta, A., Nugent, D., 2014. Risk, innovation, electricity infrastructure and construction cost overruns: Testing six hypotheses. *Energy* 74, 906-917.

SurrIDGE, A.D., Cloete, M., 2009. Carbon Capture and Storage in South Africa. Energy Procedia, 1, 2741-2744

Stackhouse, P.W., Whitlock, C.H., 2008, editors. Surface meteorology and solar energy (SSE) release 6.0, NASA SSE 6.0, earth science enterprise program. National Aeronautic and Space Administration (NASA), Langley. <http://eosweb.larc.nasa.gov/sse/>

Stackhouse, P.W., Whitlock, C.H., 2009 editors. Surface meteorology and solar energy (SSE) release 6.0 Methodology, NASA SSE 6.0, earth science enterprise program, National Aeronautic and Space Administration (NASA), Langley. <http://eosweb.larc.nasa.gov/sse/documents/SSE6Methodology.pdf>

Stetter, D., 2012. Enhancement of the REMix energy system model: global renewable energy potentials optimized power plant siting and scenario validation. Dissertation, Faculty of Energy-, Process and Bio-Engineering, University of Stuttgart.

The MathWorks, Inc. MATLAB R2016a, Massachusetts, United States, 2016.
<http://allpcworld.com/matlab-free-download/>

Toktarova, A., Gruber, L., Hlusiak, M., Bogdanov, D., Breyer, Ch., 2019. Long-term load projection in high resolution for all countries globally, International Journal of Electrical Power and Energy Systems, 111, 160-181.

Tuson, P. 2014. Small-scale on-grid PV embedded generation methodologies in South Africa. 64th AMEU convention, October 5 – 8. <https://bit.ly/2HuiZA0>

[UN] - United Nations, 2015. World Population Prospects: The 2015 Revision, Key Findings and Advance Tables. Department of Economic and Social Affairs, Population Division, Working Paper No. ESA/P/WP.241. New York. https://esa.un.org/unpd/wpp/publications/files/key_findings_wpp_2015.pdf

Verzano, K. Climate change impacts on flood related hydrological processes: further development and application of a global scale hydrological model, Reports on Earth System Science, 71, Max-Planck-Institut für Meteorologie, Hamburg, Dissertation, Faculty of Electrical Engineering and Computer Science, University of Kassel; 2009.

[WB] – World Bank, 2017. South Africa 2017 profile, Washington, DC.
http://databank.worldbank.org/data/views/reports/reportwidget.aspx?Report_Name=CountryProfile&Id=b450fd57&tbar=y&dd=y&inf=n&zm=n&country=ZAF

Wright, J. G., Bischof-Niemz, T., Calitz, J., Mushwana, C., Van Heerden, R., Senatla M., 2017. Formal comments on the Integrated Resource Plan (IRP) Update Assumptions, Base Case and Observations 2016, Pretoria. https://www.csir.co.za/sites/default/files/Documents/20170331CSIR_EC_DOE.pdf

Wright, J.G., Bischof-Niemz, T., Calitz, J.R., Mushwana, C., van Heerden, R., 2019. Long-term electricity sector expansion planning: A unique opportunity for a least cost energy transition in South Africa. Renewable Energy Focus 30, 21 – 45.

[WWF-SA] - World Wide Fund South Africa, 2014. Renewable Energy Vision 2030 – South Africa. Cape Town; 2014. http://awsassets.wwf.org.za/downloads/a16369_wwf_reip_report_online.pdf

[WWF-SA] - World Wide Fund South Africa, 2016. Water: Facts & Futures. Cape Town; 2016.
http://awsassets.wwf.org.za/downloads/wwf009_waterfactsandfutures_report_web_lowres_.pdf

[WWF-SA] - World Wide Fund South Africa, 2017. Renewable Energy: Facts and Futures, Cape Town.
https://www.crses.sun.ac.za/files/research/publications/popular-media-and-policy-brief/WWF_Energy%20Facts%20and%20Futures_Final%20Version.pdf