



*Kalevi Korjala*

**Helium as a welding shielding gas: Effects on CO<sub>2</sub> emissions by helium recovery and recycling system**

*Licentiate Thesis*

*Lappeenranta-Lahti University of Technology LUT, Finland*

*LUT School of Energy Systems*

Supervisors Emeritus Professor Jukka Martikainen  
LUT School of Energy Systems  
Lappeenranta-Lahti University of Technology LUT  
Finland

Professor Paul Kah  
(Docent of Lappeenranta-Lahti University of Technology LUT)  
Department of Engineering Science  
University West  
Sweden

Reviewers Emeritus Professor Jukka Martikainen  
LUT School of Energy Systems  
Lappeenranta-Lahti University of Technology LUT  
Finland

Doctor of Science (Technology) Jenni Toivanen  
Director  
Savonia University of Applied Sciences  
Finland

URN: NBN:fi-fe2021062840210

# Abstract

**Kalevi Korjala**

## **Helium as a welding shielding gas: Effects on CO<sub>2</sub> emissions by helium recovery and recycling system**

Licentiate Thesis 2021

136 pages

Lappeenranta-Lahti University of Technology LUT

LUT School of Energy Systems

Finland

Helium as a welding shielding gas offers unique advantages for many applications. Helium provides positive effects to most of the shielding gas mixtures used with different materials and in a variety of welding processes. Helium is an inert gas which affords more heat input to the joint, thus increasing the welding efficiency. Mixed with argon, it increases welding speed and is advantageous in penetration of thick wall aluminum, copper, and titanium materials where it compensates the high heat conduction. Drawbacks of using helium are its availability, relatively high cost and the low density. Helium can be applied in shielding as a pure gas or as a component in the shielding gas mixtures.

The objective of the thesis is to present a novel helium shielding gas recovery and recycling system devised for use in welding applications including its design and implementation. The novel system is designed by the author and it is unique in the welding shielding gas field. When using helium recovery and recycling, CO<sub>2</sub> emissions are reduced, and the climate change effects are decreased.

The thesis is based on i) literature analysis and ii) developing and designing the novel recovery system which is new and unique. The literature review and analysis describe welding shielding gases and their properties. The section handling helium addresses the production methods and applications, general properties, and effects of helium as welding shielding gas to the productivity and welding economy. The practical experience of the author accumulated during an extensive over 30 years career in the gas production business and the literature review has laid a foundation for the innovation and design of a novel helium recovery system. The designed system allows the recovery of helium from the welding processes. This innovation can potentially offer significant cost savings for various applications, and improve the understanding of inert gases recovery, extraction, and reuse. This approach leads to more sustainable manufacturing practices, at the same time decreasing the negative environmental impact of the production process. The review of scientific publications on the shielding gas field demonstrates that the recovery and recycling system designed by the author is new and unique. It is new in the welding sector and the thesis has undisputed research and scientific novel value.

**Keywords:** helium, shielding gas, welding, recovery systems, inert gas, shielding gas control, welding costs

## **Acknowledgements**

Primarily I am grateful and express my gratitude to my supervisor and reviewer Emeritus Professor Jukka Martikainen who originally encouraged me (while working in the business at the same time) to continue studies and research in this field. In our discussions, he also challenged and encouraged the idea of helium recovery and its environmental aspects. He has supported continuing the work and given important advice.

I would like to express my gratitude to my reviewer Doctor of Science (Technology) Jenni Toivanen and supervisor Professor Paul Kah. He has guided and helped me during the licentiate thesis process and shaped my ideas from the scientific point of view and improved my understanding of the whole science of welding.

Also, I would like to acknowledge the contribution of Dr. Pavel Layus, who helped me with this research on numerous occasions, and especially at its final stage. Special thanks are expressed to the real gas professionals, Mr. Jim West, and Mr. Phil Kornbluth who are the experts in everything dealing with helium gas. I am also very grateful to Mrs. Ruth Lähdeaho-Kero who has checked and corrected the English text.

My sincere gratitude is expressed to my family; my wife Anne Timberg, and children, Saara Niskanen, Joonas Korjala, Veera Korjala and Simeon Korjala and their families for their support during this work.

Special warm gratitude is expressed to my mother Hilikka Korjala, and my father, Veikko Korjala, who passed in 2000, my sister Merja Korjala, and godmother Oili Reijola, who passed in 2020, who have presented a valuable model of living and guided me through their example and experience on my own walk down the road of life.

Kalevi Korjala  
June 2021  
Lappeenranta, Finland

### *Dedication*

*This thesis is dedicated to my dear Mother Hilikka Korjala, who has been the most important person in my life. She has been always supportive, listening and guiding me with her warm thoughts and a golden heart.*

# Contents

**Abstract**

**Acknowledgements**

**Contents** **11**

**Nomenclature** **15**

**1 Introduction** **17**

- 1.1 Research background ..... 17
- 1.2 Motivation of the study ..... 17
- 1.3 Research objectives ..... 18
- 1.4 Research questions ..... 18
- 1.5 Research methods ..... 18
- 1.6 Overview of the work ..... 19
- 1.7 Impact on society and the environment ..... 20
- 1.8 Limitations and scope ..... 20
- 1.9 The main results, scientific contribution and novel value of the thesis .. 21

**2 Welding shielding gases and their properties** **24**

- 2.1 Role of welding shielding gas ..... 24
- 2.2 Common welding shielding gases ..... 25
  - 2.2.1 Argon (Ar) ..... 26
  - 2.2.2 Helium (He) ..... 27
  - 2.2.3 Carbon dioxide (CO<sub>2</sub>) ..... 27
  - 2.2.4 Oxygen (O<sub>2</sub>) ..... 27
  - 2.2.5 Nitrogen (N<sub>2</sub>) ..... 28
  - 2.2.6 Hydrogen (H<sub>2</sub>) ..... 28
- 2.3 Physical properties of shielding gases ..... 28
  - 2.3.1 Thermal conductivity ..... 28
  - 2.3.2 Electrical conductivity ..... 29
  - 2.3.3 Specific heat capacity ..... 29
  - 2.3.4 Density ..... 30
  - 2.3.5 Ionization energy ..... 31
- 2.4 Standardization of shielding gases ..... 32

**3 Helium properties, production methods and applications** **33**

- 3.1 Discovery of helium ..... 33
- 3.2 Properties of helium ..... 33
- 3.3 Helium availability ..... 36
- 3.4 Helium manufacturing processes ..... 39
  - 3.4.1 Hydrocarbon sources ..... 39
  - 3.4.2 Non-hydrocarbon sources (NHS) ..... 46
  - 3.4.3 Helium transportation ..... 47

3.5	Helium recovery from MRIs .....	51
3.6	Cost structure of helium .....	53
3.7	Applications of helium .....	59
<b>4</b>	<b>Helium as a welding shielding gas component</b> .....	<b>62</b>
4.1	The affecting properties of helium in welding .....	65
4.1.1	Gas density and molecule size .....	65
4.1.2	Ionization energy .....	67
4.1.3	Thermal conductivity .....	67
4.1.4	Influence on wetting properties .....	68
4.1.5	Defects caused by poor shielding .....	70
4.2	Applications of helium for welding different materials .....	71
4.2.1	Unalloyed carbon steels .....	71
4.2.2	Highly alloyed austenitic and non-austenitic steels .....	76
4.2.3	Aluminium and its alloys .....	76
4.2.4	Copper and its alloys .....	85
4.2.5	Titanium .....	85
4.3	The production of helium shielding gas mixtures .....	85
4.4	Optimization of the shielding gas delivery method .....	91
4.5	Helium and helium mixtures in different welding processes .....	92
4.5.1	Helium and helium mixtures in GMAW welding .....	92
4.5.2	Helium and helium mixtures in TIG welding .....	94
4.5.3	Helium and helium mixtures in laser welding .....	96
4.5.4	Helium and helium mixtures in plasma welding .....	97
4.5.5	Helium and helium mixtures in hybrid welding .....	98
4.6	Effects of shielding gases to productivity and economy of welding .....	98
4.6.1	Shielding gas effects to the productivity .....	98
4.6.2	The motivating factors of shielding gas in GMAW .....	102
4.7	Welding economy and shielding gas cost .....	106
4.8	Health and safety .....	108
<b>5</b>	<b>Helium recovery system design</b> .....	<b>112</b>
5.1	Collecting and recovery model .....	112
5.2	Weld fume specification and compounds .....	113
5.3	Description of the recovery unit and running .....	115
5.3.1	Weld fume extraction system .....	115
5.3.2	Particle removal with filters .....	116
5.3.3	Filtering systems .....	116
5.3.4	Compressing unit .....	120
5.3.5	Dryer and molecular sieve units .....	121
5.3.6	Buffer tank and analysing .....	125
5.3.7	Mixer unit .....	126
5.3.8	Feeding the recovered gas for reuse .....	127
5.4	The main results .....	128

<b>6</b>	<b>Suggestions for further study</b>	<b>130</b>
<b>7</b>	<b>Conclusions</b>	<b>131</b>
	<b>References</b>	<b>134</b>





---

## Nomenclature

AHSS	Advanced High Strength Steels
BLM	US Bureau of Land Management
CERN	The European Organization for Nuclear Research (Conseil Européen pour la Recherche Nucléaire)
CFD	Computational Fluid Dynamics
CHE	Compressed Helium
CHEU	Crude Helium Enrichment Unit
DCEP	Direct Current Electrode Positive
EN	European Norms
GHE	Gaseous Helium
GMAW	Gas Metal Arc Welding
GTAW	Gas Tungsten Arc Welding
HSE	Health, Safety and Environment
IFA	Insurance Institute for Occupational Safety
ISO	International Organization for Standardization
LAR	Liquid Argon
LHE	Liquid Helium
MAC	Maximum Allowable Concentration
MMm <sup>3</sup>	Million m <sup>3</sup> (1 000 000 m <sup>3</sup> )
MRI	Magnet Resistance Imaging
NHS	Non-Hydrocarbon Sources
PAW	Plasma Arc Welding
PSA	Pressure Swing Adsorption
PTFE	Polytetrafluoroethylene
SFS	Finnish Standards Association (Suomen Standardisoimisliitto ry)
TIG	Tungsten Inert Gas Welding
TRGS	Technical Regulations for Hazardous Substances
UHSS	Ultra High Strength Steels
URR	Ultimately Recoverable Resources
UV	Ultraviolet light
UVB	Ultraviolet B light
UVC	Ultraviolet C light



# 1 Introduction

## 1.1 Research background

Welding shielding gases or gas mixtures play an important role in gas arc welding processes. Choosing the proper gas or gas mixture, the most economical way to deliver it to the arc and the adequate flow means better quality, and more effective and economical welding and better efficiency.

The main shielding gases or mixture components are argon, helium, carbon dioxide, oxygen, nitrogen, and hydrogen. The main gas or mixture component has traditionally been argon due to its good physical properties for shielding the arc, and depending on the metal and the welding process, it is mixed with other gas components.

Helium, along with argon is a very potential and useful shielding gas or gas mixture component, having many beneficial properties which improve the welding result. Helium is the most expensive of the available shielding gases and therefore its use is limited. In the US it has been commonly used in welding applications due to the many helium sources and better availability, also its price has been reasonable. In other parts of the world utilising helium as a shielding gas has been limited.

The economy of the shielding gases in welding consists of direct and indirect costs. Direct costs include gas price, cylinder rentals, transportation costs, and the gas supply pipeline where bigger metal workshops are concerned. The indirect costs consist of leakages, suitable/unsuitable gas choice, accurate/inaccurate flow, the correct/incorrect delivery method, welding environment and design of the back-up solution for the shielding gas delivery at the workshop.

This thesis concentrates on investigating helium availability, cost structure, properties in different welding processes, and focuses especially on the possibility to recover and reuse helium and thus increase its use in welding applications. The recovery and recycling of helium is based on other applications, especially in MRI (Magnet Resistance Imaging) applications for research and diagnostics, where liquid helium is extensively used. Advanced recovery systems have been developed and these can be applied in the welding sector.

## 1.2 Motivation of the study

The background of the author is an extensive over 30 years career in the gas business, specifically at Oy Woikoski Ab, a Finnish gas company producing, handling, and transporting technical, medical and food grade gases. Helium is one of the most interesting and challenging gases in the industry and in the entire universe. The availability, cost and properties of helium have led to the idea of developing methods for the recovery and recycling of the gas and by this means to offer improved and more productive systems to customers. Environmental aspects, achieving energy savings and a

smaller carbon dioxide footprint have also motivated the work. A recovery and recycling system offers savings and increased productivity, also enhancing the environmental friendliness of the welding process.

### 1.3 Research objectives

The main objective of the research is to design a novel system for helium recovery during its application as a shielding gas (or its component). Secondary research objectives are to determine issues related to the availability of helium, its sources and production plants (refineries), also the helium price structure and the systems applied for the recovery and recycling of helium in different welding processes and in welding applications.

### 1.4 Research questions

- 1) What kind of equipment and materials are required for helium recovery and recycling in welding applications?
- 2) In which welding application does helium recovery provide positive results?
- 3) How can the helium recovered from different helium applications be utilized in welding applications?
- 4) What are the advantages of helium recovery in welding applications?
- 5) What are the challenges of helium recovery in welding applications?
- 6) What is the most beneficial method of shielding gas/gases delivery that provides efficiency and savings in the welding process?
- 7) What type of effects does the helium recovery and recycling system have on promoting a greener environment and lowering CO<sub>2</sub> emissions?

### 1.5 Research methods

The research methods used in this thesis are:

- 1) Research based on the experience

The experience gathered in building the helium recovery system in MRI field in hospitals and universities has been adapted to the welding shielding gas recovery and recycle system.

## 2) Research based on the experiments

The experimental tests have been carried out in testing the impurity removals from the welding fume components in molecular sieve purifiers.

## 3) Research based on the case studies

The case studies have been carried out in researching the global helium productions, helium availability and transportation equipment and their effective use.

## 1.6 Overview of the work

Chapter 1 is an introduction to this thesis, and it provides the research background, motivation, objectives, research questions, research limitations, and explains the impact of the thesis subject on society and the environment.

Chapter 2 addresses shielding gas properties, especially focusing on the properties of helium. The chapter clarifies the role of shielding gas in the welding process and specifies properties and characteristics of common welding shielding gases. Furthermore, various physical properties of the shielding gases are explained, such as thermal conductivity, electrical conductivity, specific heat capacity, density, and ionization energy.

Chapter 3 focuses specifically on helium properties, production methods and applications. The chapter provides a short overview of helium discovery, properties, and availability. Moreover, the detailed description of the helium manufacturing process is reviewed. Helium recovery techniques, cost structure and applications are provided.

Chapter 4 describes helium as a welding shielding gas component. The chapter covers the production of helium, and shielding gas mixtures containing helium, its special features in different welding processes, and effects of the shielding gases on welding economy and productivity. It also describes applications of helium for welding various metals, such as carbon steels, austenitic steels, aluminium, copper, and titanium. This chapter addresses choosing the right shielding gas delivery method to the welding process in use.

Chapter 5 describes the fundamentals of the helium recovery system: the novel method, materials, and devices to collect and recover helium gas during the welding process. This chapter provides the issues related to novel methods of recovering helium to improve welding economy and efficiency. By using the recovery model the environmental effects and climate change are reduced. The recovery model is innovated and designed by the author. The review of the scientific research publications indicated that this kind of recovery model has not been researched or tested in welding applications. The recovery idea developed by the author is unique and can provide many advantages to arc welding processes. From an environmental perspective, the recovery system leads to lower CO<sub>2</sub>

emissions and a lower CO<sub>2</sub> footprint, motivating actions towards a greener and cleaner world.

Chapter 6 presents health and safety precautions to be considered in the process of welding with helium shielding gas. The chapter provides an overview of various harmful components in the welding fumes and specifies potential health risks associated with these. Additionally, the chapter describes other hazardous aspects of arc welding operations.

Chapter 7 records suggestions for future research and experimental work. The chapter proposes two directions of future studies: conducting experimental investigations to confirm the design of the helium recovery system, and to study the effect of using helium as a shielding gas in welding AHSS and UHSS.

Chapter 8 presents the concluding remarks of the thesis and summarizes its conclusions.

## **1.7 Impact on society and the environment**

Our planet demands rigorous measures for recovery of raw materials and recycling them to sustain humanity as we know it. Single use of valuable resources leads to an unsustainable situation in the long run. Foundries mostly work with recycled materials, pulp and paper mills use considerable amounts of recovered paper and cardboard, and glass factories utilize recovered glass. Also plastics are now recovered. From economical aspects shielding gas welding is involved in 50-70% of all activities in the society. (American Welding Society, 2002) Techniques, materials, and devices for recovering welding shielding gases exist, are under development, and accessible, but for some reason, are not in use. The novelty of this thesis is the introduction of helium recovery resulting in reduced CO<sub>2</sub> emissions, energy use, and increased productivity. Total production costs are reduced and the CO<sub>2</sub> footprint is decreased. Helium recovery and recycling means safer and greener world.

## **1.8 Limitations and scope**

This thesis addresses the recovery and recycling of helium only. Other shielding gases, especially argon, are a potential subject for research. Large volumes of argon are widely used in foundries. Argon is also quite an expensive gas although used in bulk. This is due to a minimal argon volume (approximately 1%) in the atmosphere from where the gas is separated through a liquefaction process.

The recovery model devices and vessels use standard tested techniques extensively used in many process industry applications, also the recommended substances are standard materials. Experimental tests with the full combination of devices and materials have not yet been performed and need to be done, one by one, in the future.

## 1.9 The main results, scientific contribution and novel value of the thesis

The main results and advantages of this thesis are:

- technically it provides the opportunity to use the most appropriate welding shielding gas or shielding gas mixture in each welding application entailing efficiency, effectivity, and higher quality.
- economically it decreases the total welding, shielding gas and transportation costs, and reduces haulage equipment investments.
- environmentally it reduces CO<sub>2</sub> emissions and supports the achievement of a greener world.

Helium offers many advantages to different shielding gas welding processes but its use is limited due to its availability and high price. The main advantages of using helium are:

- good arc characteristics and metal transfer
- good fusion zone width
- high welding speed and efficiency
- good weld penetration
- good weld surface shape patterns
- avoiding undercut tendency

The novel and unique helium recovery and recycling model designed by the author and researched in this thesis offers a new approach and motivation for increasing the use of helium in shielding gas or shielding gas mixtures. By applying the recovery process, helium use becomes more effective and many technical and economic advantages are gained. The most effective shielding gas mixtures in most welding processes are combinations of argon, helium and a third component which can be carbon dioxide, oxygen, or hydrogen. The main gases are argon and helium, with the quantity of the third component being less, but giving added value to the arc shielding process. The productivity and efficiency are increased in each welding application by using the most appropriate gas mixtures and utilizing the best properties of each shielding gas component. Consideration of all the best shielding gases and their most appropriate mixtures in different welding applications results in a more active and positive role for the shielding gas in the welding process. Implementing helium recovery improves the entire welding process. Helium and argon are the most important basic components in the shielding gas mixtures.

The review of the research results of shielded welding process shows the undisputed novel value of the thesis. This presents a new approach for using shielding gases or gas mixtures in a most effective way, offering an opportunity and a new dimension for optimising the



welding process by applying the most suitable shielding gases or gas mixture where helium plays an important role.

Helium is extracted from natural gas in refineries which are situated in all continents. Helium is transported mainly in liquid form in 40-foot long, specially designed vacuum insulated containers. Typically, transport distances are thousands of kilometers per delivery, with deliveries overseas being in transit for 4-6 weeks via a lorry-ship-lorry chain. Haulage by railway is also an alternative to lorry transport. Globally less than 50 helium refineries are in operation (Helium One, 2020). This fact and the balance between the consumption and production, added with long haulage distances, and limited liquid helium transport capacity results in a very challenging helium market. The recovery and recycling of helium in applications using substantial amounts of helium is important. Of the annual global use of helium, 17% is consumed in welding shielding gas applications, welding being the second major application after MRIs (Saudi, 2017). The recovery presents an excellent opportunity to utilize the special properties of helium in welding shielding gases. The recovery and recycling of helium in welding is a new and unique way to improve and increase the effectiveness of welding processes.

The environmental and economic effects of recovering helium from welding processes are remarkable. Based on the author's experience, recycling 30% of the helium used in welding results in the following effects:

- CO<sub>2</sub> emissions are reduced about 600ton annually
- Transport costs are reduced about 1.5M€ annually
- Savings in investments into liquid helium transportation equipment are about 30M€
- Value of the recovered and recycled helium is about 40M€ annually

The welding shielding gas costs can be separated into direct and indirect costs. The direct costs comprise the actual gas price, rental of cylinders or tanks, and the costs of gas delivery and transportation, including costs associated with the installation and maintenance of the gas delivery pipeline in the workshop.

Indirect shielding gas costs include consequences of gas leakages, costs associated with cylinder exchanges, and shielding gas selection which influences arc ignition, welding speed, depth of penetration, spattering, heat input, weld deformation and weld tensions, arc time relation, and other parameters. Additionally, the selected shielding gas affects the welding safety and its cost.

The right choice of the gas mixture components and delivery method of the shielding gas plays an important role, and good planning saves considerable amounts of time and money and increases the quality and efficiency of the welding. An important factor is to use the most effective mixture components and helium is one of these. The many benefits of the recovery system encourage the use of helium. Helium and argon are the most

important welding shielding gases and the recovery system enhances the feasibility of using helium and benefiting from its many good properties.

## 2 Welding shielding gases and their properties

### 2.1 Role of welding shielding gas

The shielding gas is used to protect the welding area and to prevent the joined metals to react chemically with oxygen, nitrogen, and moisture from the surrounding air. The metallurgical and mechanical properties of the weld joint can be critically decreased by these reactions. Therefore, various methods to protect the arc from the surrounding atmosphere are used in most welding processes. Arc shielding is achieved by covering the electrode tip, the arc, and the molten weld pool with a shelter of gas or flux (or both), which inhibits exposure of the weld to the surrounding atmosphere (Groover, 2010).

The arc shielding varies according to the type of arc welding process. In all cases, the shielding is meant to:

- Protect the weld joint molten metals from the effects of the surrounding air either with gas, vapor or slag.
- Add ingredients for alloying the resultant weld metal, for example to gain improved corrosion resistance or mechanical properties such as tougher weld metal.
- Control and help the melting of the electrode and ensure the efficient use of the arc energy. Shielding gas or gas mixture can reduce welding costs and improve productivity.

The comprehensive list of parameters on which the shielding gas has an effect in the arc welding process (GMAW, TIG) (Figure 2.1):

- **Arc stability.** The shielding gas has an effect the arc ignition and its stability.
- **Material transfer.** The shielding gas has substantial effects on the material transfer, as well as the size of droplets and the forces affecting the droplets in the arc.
- **Mechanical properties and metallurgy.** The shielding gas influences the losses of alloy materials and the dissolving of oxygen, nitrogen, hydrogen, and carbon into the molten pool. These have effects the corrosion and the mechanical properties of the weld.
- **Shielding effect.** The shielding gas protects the molten pool and the hot metals, shielding them from the effects of the surrounding air.
- **Weld appearance.** The shielding gas has substantial effects on the amounts of spatters and slag.
- **Weld profile shape.** The shielding gas has an effect the height of the weld bead and its shape, the weld penetration, and its fusion with the base material.

- **Welding speed and cost.** The shielding gas or gas mixture affects the welding speed and the total welding costs.
- **Work environment.** The shielding gas has an effect the formation of welding fumes.

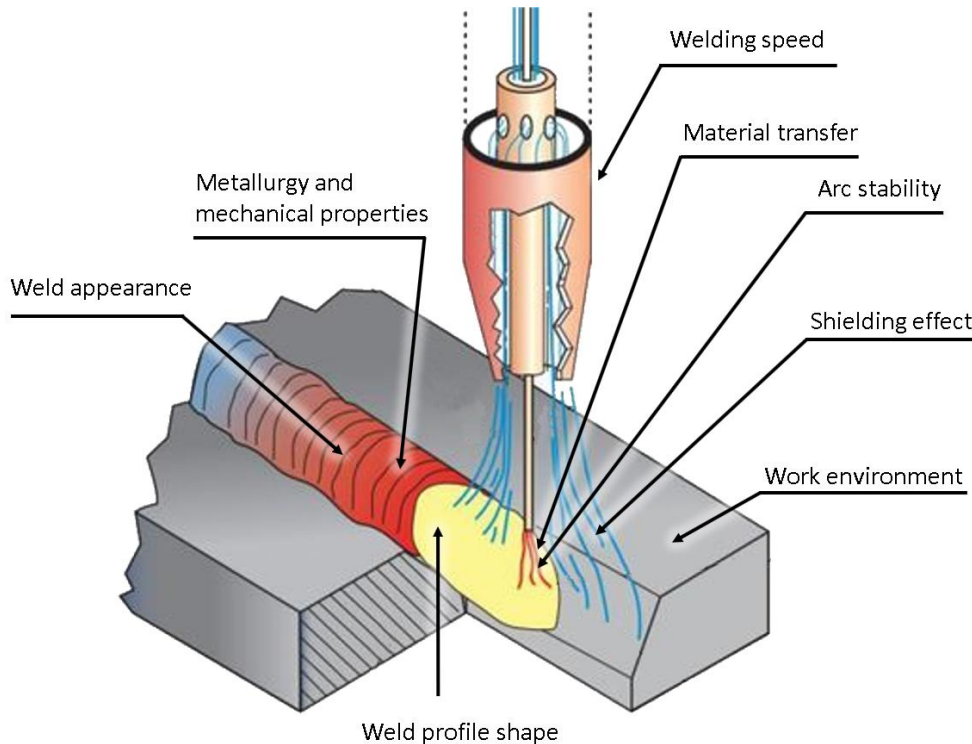

Figure 2.1: Effects of the shielding gas on the GMAW process (Modified from Jeffus, 2012).

In laser welding, the shielding gas is used to:

- prevent oxidation of the molten material
- reduce spatter
- protect the laser focusing optics
- suppress plasma formation above the keyhole in deep penetration welding.
- an air knife is often used in conjunction with the gas shield.

## 2.2 Common welding shielding gases

The shielding gases used for gas arc welding are argon, helium, carbon dioxide, oxygen, nitrogen, hydrogen, and their mixtures. Argon and helium are inert gases, meaning they are not reactive with any substances or metals. Carbon dioxide and oxygen are oxidizing. With the specific welding processes in the welding of ferrous metals oxygen and/or carbon dioxide are used, in the combination with argon and/or helium, to create an

oxidizing environment to the weld pool and to influence the weld shape and the stability of the welding process. Nitrogen is low -reactive and hydrogen is reducing (Groover, 2010).

From a chemical viewpoint the shielding gases influence the formation of oxides in the weld metal. The main properties of various gases are presented in Table 2.1. This chapter will provide descriptions of these gases as a shielding gas for the welding process.

Table 2.1: Properties of gases (Compressed Gas Association Inc. , 1999).

<b>Gas</b>	<b>Molecular weight (g/mol)</b>	<b>Atom radius (pm)</b>	<b>Ionization energy (eV)</b>	<b>Thermal conductivity (W/m x K)</b>	<b>Heat capacity (kJ/kg x K)</b>
Argon	39.9	71	15.8	0.017	0.520
Carbon dioxide	44		14.0	0.015	0.850
Helium	4	31	24.6	0.15	5.193
Oxygen	32	60	13.6	0.03	0.918
Nitrogen	28	70	14.5	0.03	1.040
Hydrogen	2	25	13.6	0.18	14.304

### 2.2.1 Argon (Ar)

Argon is the most common shielding gas due to its suitable properties, its availability and price. Welding grade argon is produced by an air distillation process and purified to a minimum level of 99.95%. This is acceptable for welding of most metals. With certain special metals (as reactive and refractory metals) a higher argon purity is required (>99.997%).

Argon as a welding shielding gas has the following advantages:

- Smooth arc action
- Easy arc ignition
- Good penetration profile of thin material welding
- Cleaning action when welding materials such as aluminium and magnesium
- Reasonable cost and good availability
- High density (lower flow rate for good shielding)
- Good cross-draft resistance

The reduced penetration of an argon shielded arc is helpful in manual welding of thin materials, because the excessive melt through tendency is reduced. This same characteristic is advantageous in vertical or overhead welding since the sag tendency for the weld metal is decreased.

In case of GMAW of mild steel with inert gases (argon and/or helium), added CO<sub>2</sub> or O<sub>2</sub> enhances welding properties. The addition of CO<sub>2</sub> (up to 20%) improves weld penetration while 5–8% CO<sub>2</sub> addition decreases spatters (Weman, 2012).

### 2.2.2 Helium (He)

Helium is an inert gas as argon. Welding grade helium is purified to a purity level of minimum 99.99%. Helium transfers more heat into the workpiece than argon with determined values of welding current and arc length. The greater heating power of the helium arc is an advantage when joining metals with high thermal conductivity and with high velocity mechanized applications. Helium can provide better penetration compared to argon and this is a real advantage in many welding applications.

Mixed with argon, helium allows the increase of welding speed and it is advantageous for penetration in thick-walled aluminium or copper where helium compensates for the high heat conduction. Drawbacks of helium are its availability, relatively high price and low density. The low density means that higher gas flow rate must be used to secure the shielding effect. The high content of helium reduces ignition properties especially with TIG welding (Weman, 2012).

### 2.2.3 Carbon dioxide (CO<sub>2</sub>)

Pure carbon dioxide (CO<sub>2</sub>) can be solely used for short arc welding. It is an inexpensive gas, suitable for welding galvanised and carbon steel, it has a good penetration and it protects against lack of fusion better than argon-based gas mixtures. The negative properties of using CO<sub>2</sub> are a greater amount of spatter and the fact the CO<sub>2</sub> cannot be used for spray transfer arc welding.

In the high temperature of the arc CO<sub>2</sub> dissociates and forms free oxygen atoms. They react with the melted metal and cause also spatters. Alloying substances such as manganese and silicon, form slag into the weld or on its surface. This decreases the amount of alloying effect in the melted material but it can be compensated with a higher alloyed filler material (Compressed Gas Association Inc. , 1999).

### 2.2.4 Oxygen (O<sub>2</sub>)

Oxygen is used as a minor component to stabilise the arc in GMAW with inert gases. In this case oxygen is an alternative to CO<sub>2</sub>. A higher content of oxygen is avoided because it forms excessive slag and oxides in the weld. When used together with CO<sub>2</sub> the forming

of slag increases and alloying elements in steel decreases its mechanical and operational properties (Compressed Gas Association Inc. , 1999).

### 2.2.5 Nitrogen (N<sub>2</sub>)

Nitrogen is an alloying substance in the duplex stainless steels welding. A small nitrogen addition in the shielding gas compensates for N<sub>2</sub> losses. In copper welding nitrogen mixtures can be used to increase the heat input, because nitrogen has no negative impact on the metallurgy of copper. Nitrogen is also used as a root shielding gas, often combined with hydrogen (Weman, 2012).

### 2.2.6 Hydrogen (H<sub>2</sub>)

Hydrogen can be used to increase heat input and welding speed. Hydrogen is a cheap gas and the increase can be done at low cost. The drawback with H<sub>2</sub> is the risk of cracks due to the hydrogen brittleness and therefore hydrogen can only be used for welding of austenitic stainless steels. Owing to the risk of porosity, hydrogen content is limited to a few percent of the total composition of a shielding gas and is only recommended for one bead welds. Hydrogen also actively reduces oxides and is used as a root gas, often in combination with nitrogen (Weman, 2012).

## 2.3 Physical properties of shielding gases

The key physical properties of shielding gases used for welding are their thermal conductivity, electrical conductivity, heat transfer properties, density and the ionization potential.

### 2.3.1 Thermal conductivity

Thermal conductivity determines the radial transfer of heat from the arc centre to the periphery of the arc and therefore it specifies the arc core size. It affects the arc thermal profile and thus the weld shape and the penetration depth. Gas mixtures with high thermal conductivity components improve the weld bead geometry, provide a better penetration profile and improve fusion characteristics. Thermal conductivity for most common shielding gases is shown in Figure 2.2.

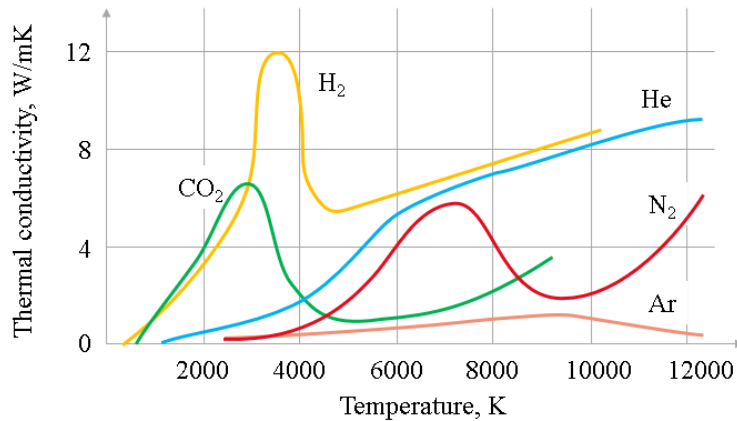

Figure 2.2: Thermal conductivity of common shielding gases (Boulos, et al., 2015).

### 2.3.2 Electrical conductivity

Electrical conductivity (resistance) is an important feature of a welding shielding gas. For example, the lower electrical resistance of argon allows for lower voltages than when welding with helium. The electrical characteristics of argon are compatible with the lower voltages required in the short-arc process. Argon permits the operation of lower voltages at any amperage setting, therefore it suits better for the welding of thin metals (Laughton & Warne, 2003). The temperature dependence of the electrical conductivity is indicated in Figure 2.3.

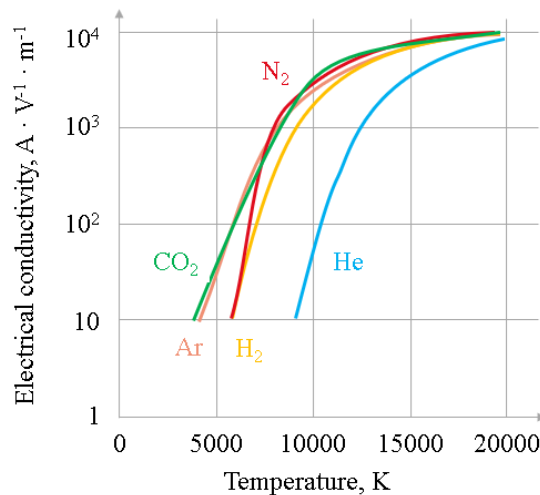

Figure 2.3: Temperature dependence of the electrical conductivity of common shielding gases at  $p = 100 \text{ kPa}$  (Boulos, et al., 2015).

### 2.3.3 Specific heat capacity

The specific heat capacity indicates the value of the gas ability to absorb and store heat. The arc thermal and weld bead profile and fusion characteristics are affected by the gas



specific heat. Gas mixtures with high specific heat capacity components improve fusion characteristics and bead profile geometry. The specific heat capacities of main shielding gases at 21.1 °C and at atmospheric pressure are expressed in Figure 2.4.

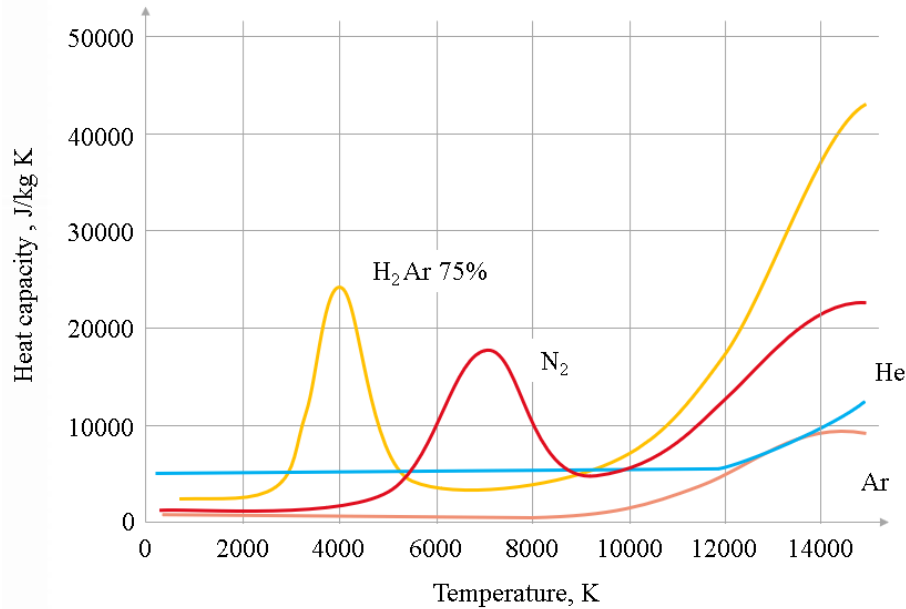

Figure 2.4: Heat capacity of common shielding gases (Aissa, et al., 2013).

### 2.3.4 Density

One of the main reasons for applying the weld pool shielding is to protect it from the harmful effects of the surrounding atmosphere. Gas density is an important factor in the shielding process, the high density means lower shielding gas flow and enhanced weld pool shielding efficiency. Gases heavier than air (e.g. argon) shroud the weld and require lower flow rates than gases that are lighter than air (e.g. helium) (Lytle & Stapon, 2005). Argon and carbon dioxide are good examples of high density gases. The density of helium is low and therefore a higher gas flow is required to build up a good shielding effect from the surrounding atmosphere. When a good and effective shield is required in the welding zone, it is important that the gas or the gas mixture does not disperse. Therefore, gas mixtures containing high and low density components are used simultaneously offering effective elements to the welding process, Figure 2.5.

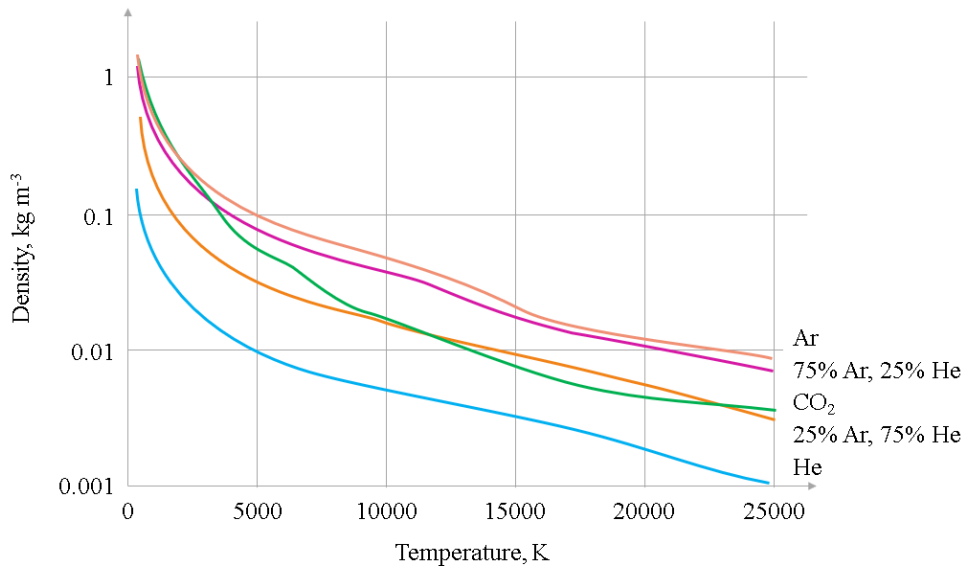

Figure 2.5: Density of common shielding gases (Murphy & Lowke, 2018).

### 2.3.5 Ionization energy

The ionization energy (potential) is reflected to the easiness of the arc ignition and the constancy of the stable arc. Ionization energy is the minimum energy required to release one electron from an atom or molecule and to form an arc, Figure 2.6. If the ionization energy is high, as is the case with helium, ignition and maintaining a stable arc is more difficult. A remedy for lowering the ionization energy is to make a gas mixture. Ionizability determine how easily the arc ignites, and what voltage is required.

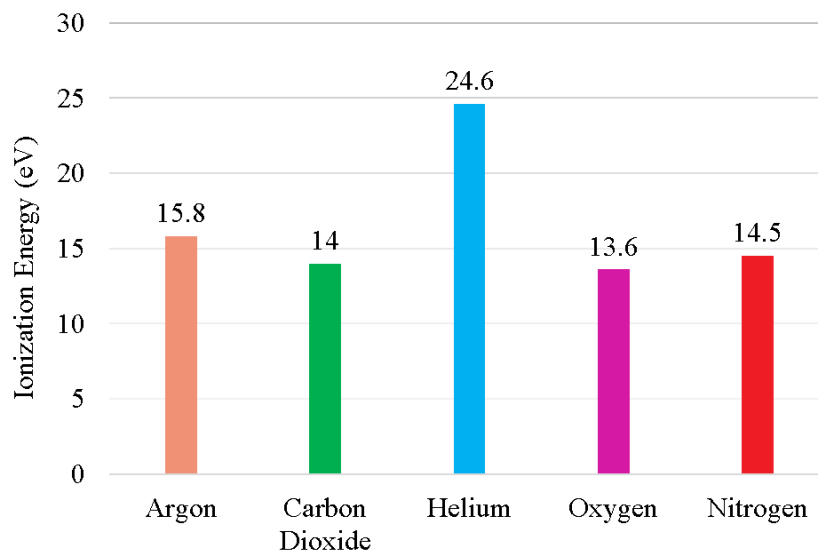

Figure 2.6: Ionization energy of common shielding gases (Modified from Weman, 2012).

In laser welding, the shielding gas has an extra task which is to prevent the formation of a plasma cloud over the weld, absorbing a considerable portion of the energy of the laser (CO<sub>2</sub> based lasers). Lasers which are based on Nd: YAG indicate lower predisposition to form such a plasma. Helium gas performs best in these scenarios due to its high ionization energy.

## 2.4 Standardization of shielding gases

In the European standard EN ISO 14175 Welding consumables - Gases and gas mixtures for fusion welding and allied processes, the shielding gases for different methods are classified in accordance with their chemical properties. The required gas purities and tolerances of gas mixtures with two or more gases are also specified.

The gases included in EN ISO 14175 are argon, helium, carbon dioxide, oxygen, nitrogen, and hydrogen. Their physical and chemical properties are summarized in Table 2.2. Only helium and hydrogen are considerably lighter than air. Carbon dioxide and argon are much heavier than air. At 15°C and atmospheric pressure all are in gaseous phase. In a compressed state (normally 200 to 300bar in cylinders) all of them remain gaseous except carbon dioxide, which is liquid at above 40bar at 15°C.

Table 2.2: Properties of shielding gases used in fusion welding (EN ISO 14175).

Gas	Symbol	Defined at 0°C, 1.013 bar (0.101 MPa)		Boiling point, 1.013 bar °C	Property in welding
		Density (air=1.293) kg/m <sup>3</sup>	Relative density compared to air		
Argon	Ar	1.784	1.380	-185.9	inert
Helium	He	0.178	0.138	-268.9	inert
Carbon Dioxide	CO <sub>2</sub>	1.977	1.529	-78.5 <sup>1)</sup>	oxidizing
Oxygen	O <sub>2</sub>	1.429	1.105	-183.0	oxidizing
Nitrogen	N <sub>2</sub>	1.251	0.968	-195.8	low reactivity <sup>2)</sup>
Hydrogen	H <sub>2</sub>	0.090	0.070	-252.8	reducing
1) Sublimation temperature (limit from solid to gaseous phase).					
2) The reaction of nitrogen varies depending on material. The negative effect to be considered.					

## 3 Helium properties, production methods and applications

### 3.1 Discovery of helium

In the gaseous atmosphere surrounding the Sun helium was found by Pierre Jules Cécár Jansen (1824-1907), a French scientist and astronomer. The first proof of helium was discovered on the 18<sup>th</sup> of August 1868, as a bright yellow line (with a wavelength of 587.49 nm) was found in the spectrum of the Sun's chromosphere. Originally the line was thought to represent the element sodium. The same year Joseph Norman Lockyer (1836-1920) who was an English astronomer observed a yellow line in the solar spectrum that did not match the known D<sub>1</sub> and D<sub>2</sub> lines of sodium, so he gave it the new name: the D<sub>3</sub> line. It was concluded that the D<sub>3</sub> line was caused by an element in the Sun that was not known on Earth. Lockyer and the chemist Edward Frankland chose the Greek word, "hēlios" (ἥλιος) meaning sun to get the new element named. The presence of helium on our planet was discovered in 1895 by the British chemist Sir William Ramsay (1852-1916). Ramsay found a sample of the uranium bearing mineral cleveite and when investigating the gas released by heating the sample, he discovered that a unique bright yellow line in its spectrum matched that of the D<sub>3</sub> line found in the Sun's spectrum. The new chemical element of helium was thus categorically identified. During the first years of the 20th century, Ramsay and Frederick Soddy ended up to a conclusion that helium is a product of the natural disintegration of radioactive substances (Ramsay & Soddy, 1903), Figure 3.1.

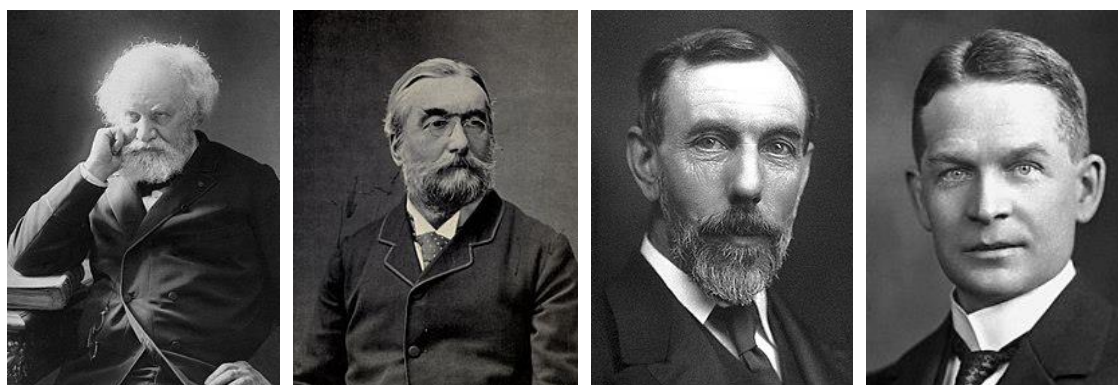

Pierre Jules César  
Jansen

Joseph Norman  
Lockyer

Sir William  
Ramsay

Frederick Soddy

Figure 3.1: Scientists who discovered helium (Nath, 2013).

### 3.2 Properties of helium

Helium (He) (an inert gas) is a chemical element which belongs in the periodic table of Group 18 (noble gases). Helium is the second lightest element (only hydrogen is lighter),

it is an odourless, colourless and tasteless gas that liquefies at  $-268.9\text{ }^{\circ}\text{C}$ , Figure 3.2. The atomic weight of helium is  $4\text{ g/mol}$ . Its freezing and boiling points are lower than any other known substance. Helium is the only element that cannot be solidified by cooling at normal atmospheric pressure but it is necessary to use  $25\text{bar}$  pressure at a temperature of  $1\text{ K}$  ( $-272\text{ }^{\circ}\text{C}$ ) to transform it to solid form. Helium is an inert gas and it has many applications. In welding it is used as a shielding gas in various arc welding processes to protect the weld from atmospheric contamination. Helium has eight known isotopes from which only two are stable, namely helium 3 and helium 4. The helium in the normal atmosphere consists of helium 4 -  $99,999863\%$  and helium 3 -  $0,000137\%$ . From a safety aspect, helium can cause suffocation by replacing oxygen.

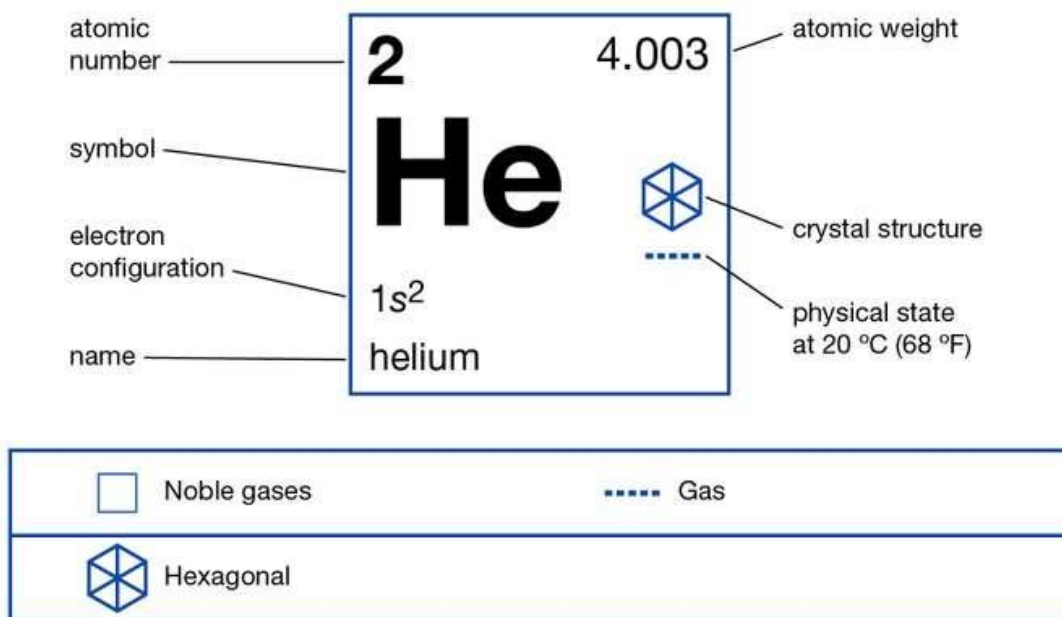

Figure 3.2: Description of helium (The Editors of Encyclopaedia Britannica, 2020).

Figure 3.3 a-f presents physical properties of helium as a function of temperature. The thermal conductivity of helium is extremely high. The ionization energy of helium is the highest of the shielding gases. Helium can be used at extremely high, and extremely low temperatures.

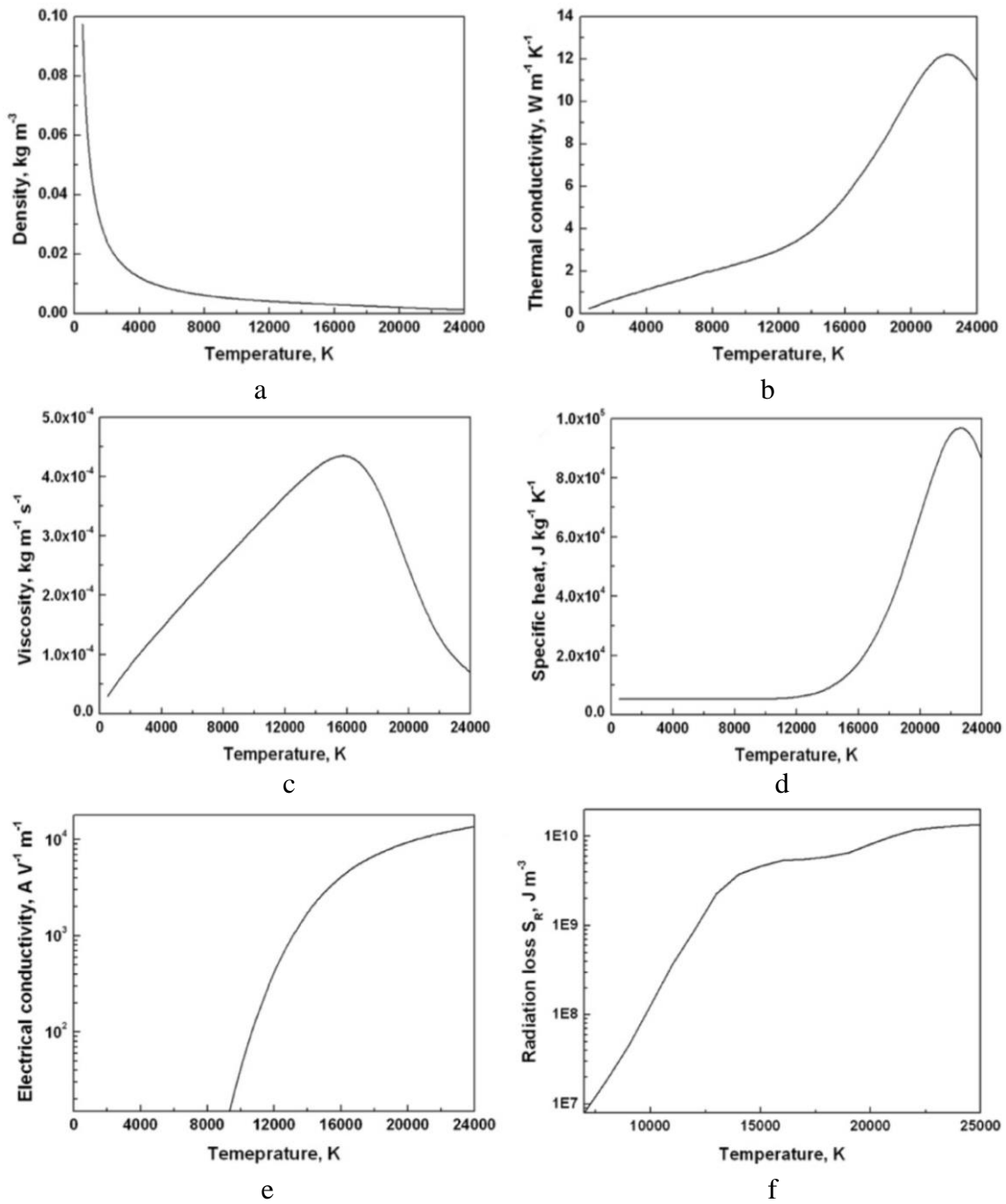

Figure 3.3: Physical properties of helium as a function of temperature. (a) Density (Boulos, et al., 2015). (b) Thermal conductivity (Boulos, et al., 2015). (c) Viscosity (Boulos, et al., 2015). (d) Specific heat (Boulos, et al., 2015). (e) Electrical conductivity (Boulos, et al., 2015). (f) Radiation loss (Cram, 1985).

### 3.3 Helium availability

Helium forms about 23 percent of the mass of the universe and is the second in the abundance in the cosmos after hydrogen. Helium is concentrated in stars, where it is synthesized by nuclear fusion from hydrogen.

Helium occurs in Earth's atmosphere only to the extent of 5ppm(vol) (0.0005 %) and small amounts are found in radioactive minerals, meteoric iron, and mineral springs. Helium has been discovered as an impurity component (up to 7.6 %) in natural gas especially in the United States (Texas, New Mexico, Kansas, Oklahoma, Arizona, Wyoming and Utah). Helium sources have also been discovered in Algeria, Australia, Poland, Qatar, China, Iran, Canada and Russia. Ordinary air contains 5 ppm(vol) of helium, and Earth's crust only about 8 parts per billion (ppb) (vol.) (Korjala, et al., 2017). The availability of helium is limited. On the other hand, helium applications are continuously increasing and each one takes up a part of the helium available on the market. Figure 3.4 and Figure 3.5 show current and forecasted helium production by countries.

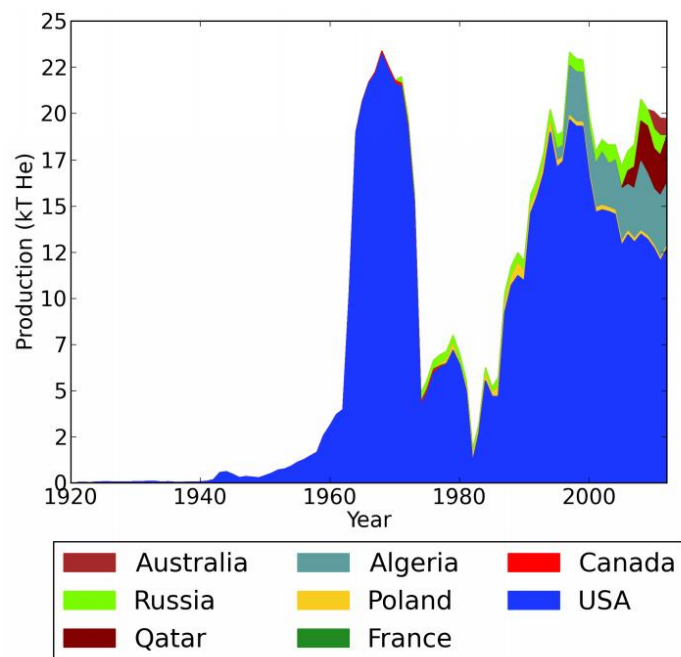

Figure 3.4: Helium production by country (Mohr & Ward, 2014).

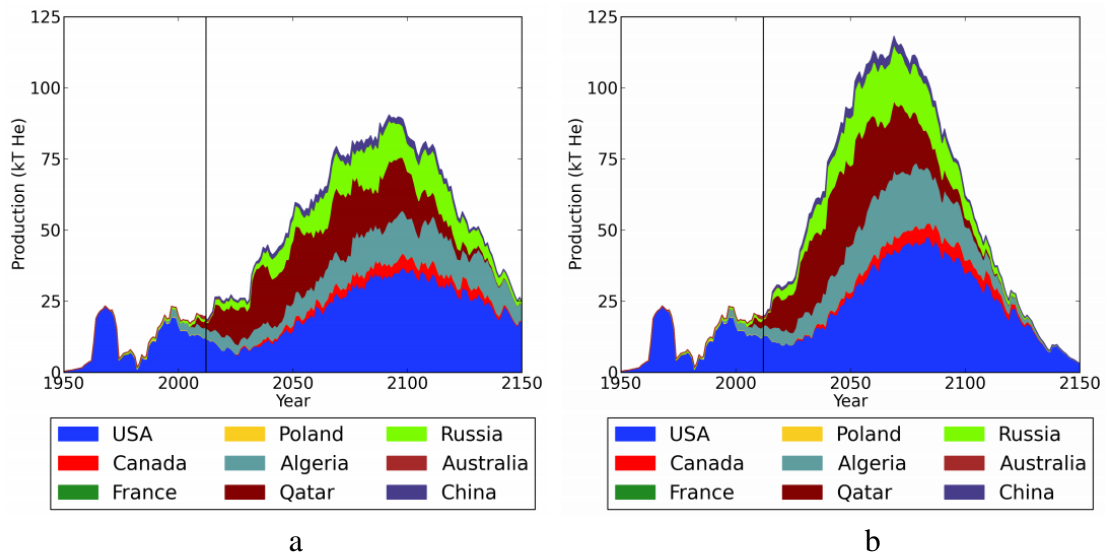

Figure 3.5: Projection of helium production in the world by country. (a) Regular growth. (b) High growth (Mohr & Ward, 2014).

The amount of helium in the air is small, 0.0005%, so the commercial production of helium is based on certain natural gas sources with a high helium content of more than 0.4%. In most cases, after extraction from the natural gas source, the helium is purified and delivered in a liquid or gaseous state.

The analysis of helium production, resources and ultimately recoverable resources was conducted in 2014, Table 3.1. The helium ultimate recoverable resource (URR) reserves are concentrated in six main countries, namely USA, Qatar, Algeria, Russia, Canada, and China. Total helium sources volume percentage of these five countries is 99 %. From the known helium reserves USA is having 46%, Qatar 19%, Algeria 16%, Russia 13%, and Canada 4% and China 2%. The total volume of the known recoverable reserves is 9064 kt.

Table 3.1: The helium resources of the world by country in kt He (2014).

Country	Cumulative production	Resources	Ultimately recoverable resources (URR)	Reference
USA	687	3491	4178	(Pacheco & Ali, 2008)
Qatar	14	1710	1723	(National Minerals Information Center, 2020)
Algeria	47	1388	1435	(National Minerals Information Center, 2020)



Russia	26	1151	1177	(National Minerals Information Center, 2020)
Canada	2	339	340	(National Minerals Information Center, 2020)
China	0	186	186	(National Minerals Information Center, 2020)
Poland	10	5	15	(Czapigo-Czapla, 2012)
Australia	3	5	8	(Mohr & Ward, 2014)
<b>World</b>	<b>789</b>	<b>8275</b>	<b>9064</b>	

Currently, more than ten new production plants are under construction and will be completed within the following years (2020-2026). The total annual production volume will probably increase in 2026 and will constitute as much as 135 Mm<sup>3</sup>/y, which is shown in Table 3.2. These new projects are needed because the existing old sources in US (BLM), Russia (Orenburg) and Poland (Odolanow) are declining.

Table 3.2: New helium production plants projects.

<b>Project</b>	<b>Country</b>	<b>Expected delivery volumes annually*</b>	<b>Expected Start-Up</b>
Shiprock Helium	USA	50	2019
Tenawa Che	USA	120	2019
SW USA Che	USA	100	2019-2022
Qatar 3	Qatar	425	2020
Renegen	South Africa	25	2020
ARZEW	Algeria	200	2020
AB/SK	Canada	100	2020-2022
Irkutsk Oil	Russia	250	2021
Gazprom-Amur	Russia	2100	2021/2022/2026
Qatar 4	Qatar	700	2024

Iran-South Pars	Iran	700	
<b>All projects</b>		<b>4770</b> <b>(135 Mm<sup>3</sup>/year)</b>	<b>2019-2026</b>

\* pcs of 40 000 L containers, equal to 28 300 Nm<sup>3</sup> each.

### 3.4 Helium manufacturing processes

Helium is the product of uranium, thorium, and actinium alpha dissociation. One ton of uranium bound in minerals produces 0.12 cm<sup>3</sup> of helium/year. The total reserve of helium in the atmosphere, lithosphere and hydrosphere equals 5 x 10<sup>14</sup> m<sup>3</sup>. The helium concentration in air is 5.2 ppm(vol). Most of the helium used nowadays is extracted during the purification of natural gas for pipeline transportation and recovered during the natural gas liquefaction process. Natural gas sources in different parts of the world consist of different amounts of helium. The highest concentration in natural gas has been about 7%, but normally the concentrations are 0.05%-0.5%. When liquefying natural gas the non-liquefied part of the gas comprises different impurities including nitrogen and helium. The impurities are removed with a combination of molecular sieves, membranes, and cryogenic separation, after which pure helium gas is liquefied. The boiling point of helium is 4.22 K (- 268.93 °C).

Small concentrations of helium have been found in springs, volcanoes, and fumaroles. Promising concentrations have been detected in coal-bed methane and in some carbon dioxide fields and even gold mines, but these have not been exploited commercially except for a carbon dioxide helium source plant in the United States. Helium is also created by nuclear fusion of hydrogen in stars and represents roughly 25% of the mass of the sun.

The production of helium from its geological source depends on the geological setting of the helium. Two main categories define helium production sources:

- hydrocarbon sources
- non-hydrocarbon sources (NHS)

#### 3.4.1 Hydrocarbon sources

Helium is commonly produced as a by-product of natural gas extraction. Most natural gas deposits have small quantities of nitrogen, carbon dioxide, water vapor, helium, and other non-combustible materials. These materials are considered impurities, as they reduce the possible heat energy of the natural gas. To produce natural gas with an appropriate level of heat energy, these impurities must be removed. This process is referred to as upgrading of the natural gas.

A few techniques are known for upgrading the natural gas. When the gas contains more than 0.4% helium by volume, a cryogenic distillation method is often used to recover the

helium content. Once the helium has been separated from the natural gas, it undergoes further refining to raise the purity to 99.99+ % for commercial use.

Commonly, helium production comprises the following steps (MadeHow, 2019):

1. Pretreating
2. Separating
3. Purifying
4. Distributing

### **3.4.1.1 Preparation**

Preparation is a process for removing the impurities from the natural gas. The helium by-product production method utilizes cryogenic temperatures, and thus the impurities that might solidify—such as water vapor, carbon dioxide, and certain heavy hydrocarbons—must be removed.

- 1 The natural gas is pressurized to about 5.5 MPa. It then flows into a scrubber where it is subjected to a spray of monoethanolamine which absorbs the carbon dioxide and removes it.
- 2 The gas stream passes through a molecular sieve, which strips the larger water vapor molecules from the stream while letting the smaller gas molecules pass. The water is back flushed out of the sieve and removed.
- 3 Any heavy hydrocarbons in the gas stream are collected on the surfaces of a bed of activated carbon as the gas passes through it. Periodically the activated carbon is recharged. The gas stream now contains mostly methane and nitrogen, with small amounts of helium, hydrogen, and neon.

### **3.4.1.2 Separating**

Natural gas is separated into its major components through a distillation process known as fractional distillation. Sometimes this name is shortened to fractionation, and the vertical structures used to perform this separation are called fractionating columns. In the fractional distillation process, the nitrogen and methane are separated in two stages, leaving a mixture of gases containing a high percentage of helium. At each stage, the level of concentration, or fraction, of each component is increased until the separation is complete. In the natural gas industry, this process is sometimes called nitrogen rejection, because its primary function is to remove excess quantities of nitrogen from the natural gas. The process of preparation and separation is illustrated in Figure 3.6.

- 4 The gas stream passes through one side of a plate fin heat exchanger while cold methane and nitrogen from the cryogenic section pass through the other side. The incoming gas stream is cooled, while the methane and nitrogen are warmed.
- 5 The gas stream then passes through an expansion valve, which allows the gas to expand rapidly while the pressure drops to about 1.0-2.5 MPa. This rapid expansion cools the gas stream to the point where the methane starts to liquefy.
- 6 The gas stream—now part liquid and part gas—enters the base of the high-pressure fractionating column. As the gas works its way up through the internal baffles in the column, it loses additional heat. The methane continues to liquefy, forming a methane-rich mixture in the bottom of the column while most of the nitrogen and other gases flow to the top.
- 7 The liquid methane mixture, called crude methane, is drawn out of the bottom of the high-pressure column, and is cooled further in the crude subcooler. It then passes through a second expansion valve which drops the pressure to about 22 psi (150 kPa or 1.5 bar) before it enters the low-pressure fractionating column. As the liquid methane works its way down the column, most of the remaining nitrogen is separated, leaving a liquid that is no more than about 4% nitrogen and the balance is methane. This liquid is pumped off, warmed, and evaporated to produce upgraded natural gas. The gaseous nitrogen is piped off the top of the low-pressure column and is either vented or captured for further processing
- 8 Meanwhile, the gases from the top of the high-pressure column are cooled in a condenser. Much of the nitrogen condenses into a vapor and is fed into the top of the low-pressure column. The remaining gas is called crude helium. It contains about 50-70% helium, 1-3% unliquefied methane, small quantities of hydrogen and neon, and the balance is nitrogen.

Once separated from the natural gas, crude helium is purified in a multi-stage process involving several different separation methods depending on the purity of the crude helium and the intended application of the final product.

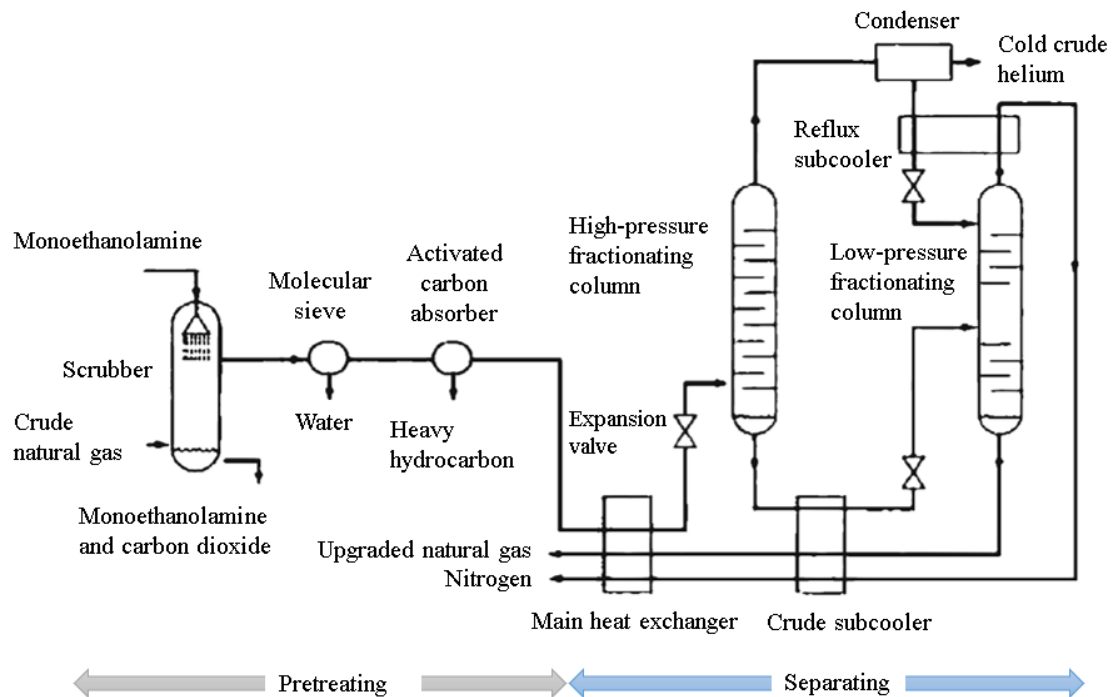

Figure 3.6: Preparation and separating phases of helium production (J.R. Campbell & Associates, Inc., 2013).

### 3.4.1.3 Purifying

Crude helium must be further purified to remove most of the other materials. This is usually a multi-stage process involving several different separation methods depending on the purity of the crude helium and the intended application of the final product. The process is illustrated in Figure 3.7.

- 9 The crude helium is first cooled to about  $-193^{\circ}\text{C}$ . At this temperature, most of the nitrogen and methane condense into a liquid and are drained off. The remaining gas mixture is now about 90% pure helium.
- 10 Air is added to the gas mixture to provide oxygen. The gas is warmed in a preheater and then it passes over a catalyst, which causes most of the hydrogen in the mixture to react with the oxygen in the air and form water vapor. The gas is then cooled, and the water vapor condenses and is drained off.
- 11 The gas mixture enters a pressure swing absorption (PSA) unit consisting of several absorption vessels operating in parallel. Within each vessel are thousands of particles filled with tiny pores. As the gas mixture passes through these particles under pressure, certain gases are trapped within the particle pores. The pressure is then decreased and the flow of gas is reversed to purge the trapped gases. This cycle is repeated after a few seconds or few minutes,

depending on the size of the vessels and the concentration of gases. This method removes most of the remaining water vapor, nitrogen, and methane from the gas mixture. The helium is now about 99.99% pure.

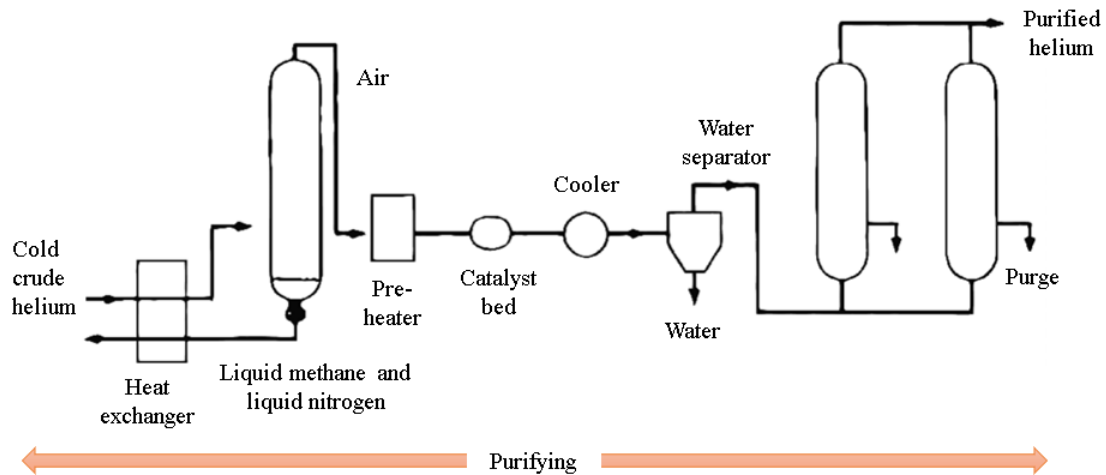

Figure 3.7: The purifying phase of helium production (J.R. Campbell & Associates, Inc., 2013).

#### 3.4.1.4 Distributing

Helium is distributed either as a gas at normal temperatures or as a liquid at low temperatures. Gaseous helium is distributed in forged steel or aluminium alloy cylinders at pressures in the range of 6-41 MPa. Bulk quantities of liquid helium are distributed in insulated containers with capacities up to about 56,000 litres. The processes of liquifying and distributing are indicated in Figure 3.8.

- 12 If the helium is to be liquefied, or if higher purity is required, the neon and any trace impurities are removed by passing the gas over a bed of activated carbon in a cryogenic adsorber operating at about  $-253^{\circ}\text{C}$ . Purity levels of 99.999% or better can be achieved with this final step.
- 13 The helium is then piped into the liquefier, where it passes through a series of heat exchangers and expanders. As it is progressively cooled and expanded, its temperature drops to about  $-269^{\circ}\text{C}$  and it liquefies.
- 14 Large quantities of liquid helium are usually shipped in unvented, pressurized containers. If the shipment is within the continental United States, shipping time is usually less than a week. In those cases, the liquid helium is placed in large, insulated tank trailers pulled by truck tractors. The tank body is constructed of two shells with a vacuum space between the inner and outer shell to retard heat loss. Within the vacuum space, multiple layers of reflective foil further halt heat flow from the outside. For extended shipments overseas, the helium is placed

in special shipping containers. In addition to a vacuum space to provide insulation, these containers also have a second shell filled with liquid nitrogen to absorb heat from the outside. As heat is absorbed, the liquid nitrogen boils off and is vented.

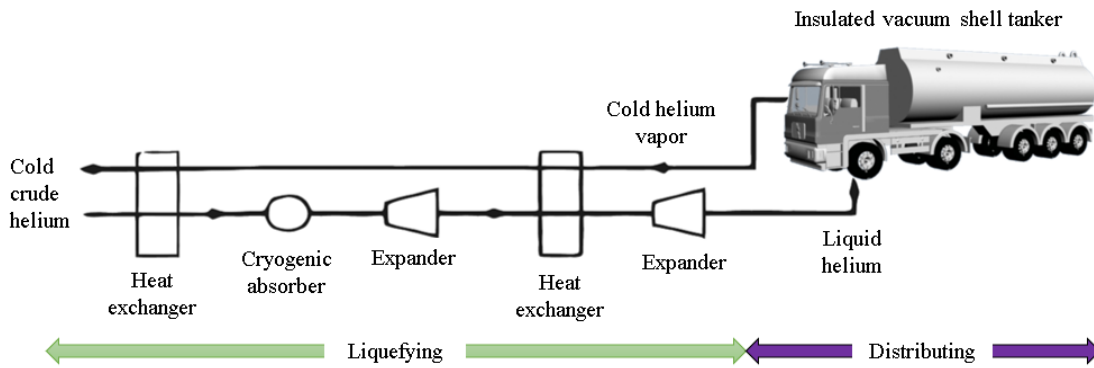

Figure 3.8: Liquefying and distributing phases of helium production (J.R. Campbell & Associates, Inc., 2013).

Figure 3.9 is a schematic flow diagram of the helium extraction process from natural gas in US Kansas area where part of the crude helium (50-70%) can be stored to the local pipeline and storage system. Figure 3.10 shows a Crude Helium Enrichment Unit (CHEU) located in the USA.

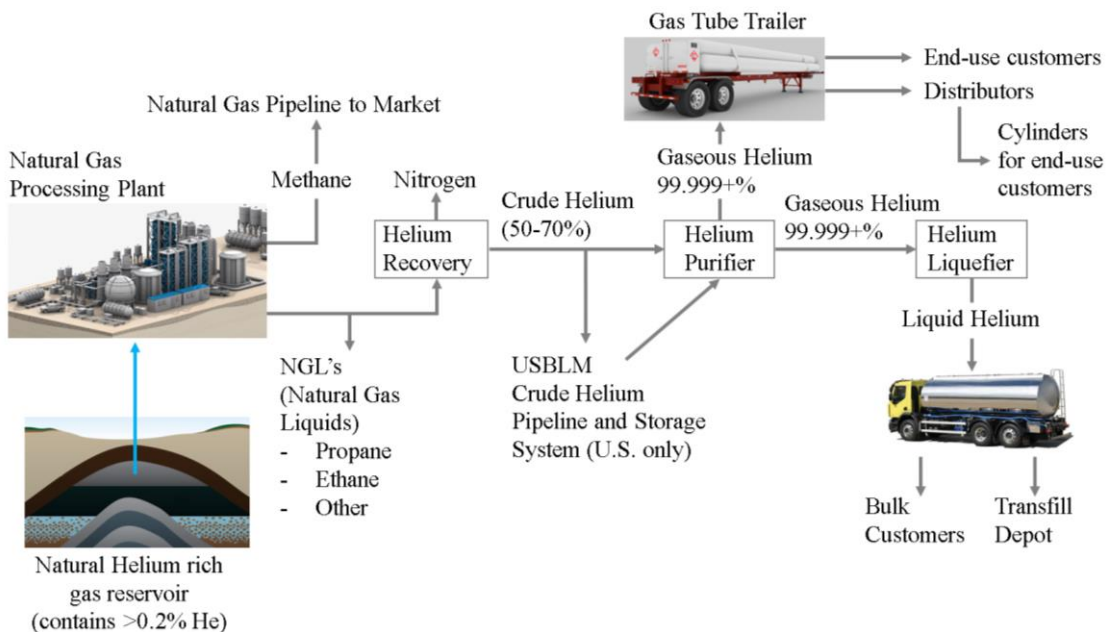

Figure 3.9: Schematic diagram of the helium extraction process from natural gas (J.R. Campbell & Associates, Inc., 2013).

The biggest helium crude liquefaction plants, which separate helium, natural gas and other by-products are in the US, Russia, Algeria, Qatar, Australia and China, shown in

Figure 3.10. Also, in Europe is a small liquefaction plant located in Poland. Figure 3.11 shows helium production facilities which produce helium from natural gas.



Figure 3.10: Crude Helium Enrichment Unit (BLM, USA).

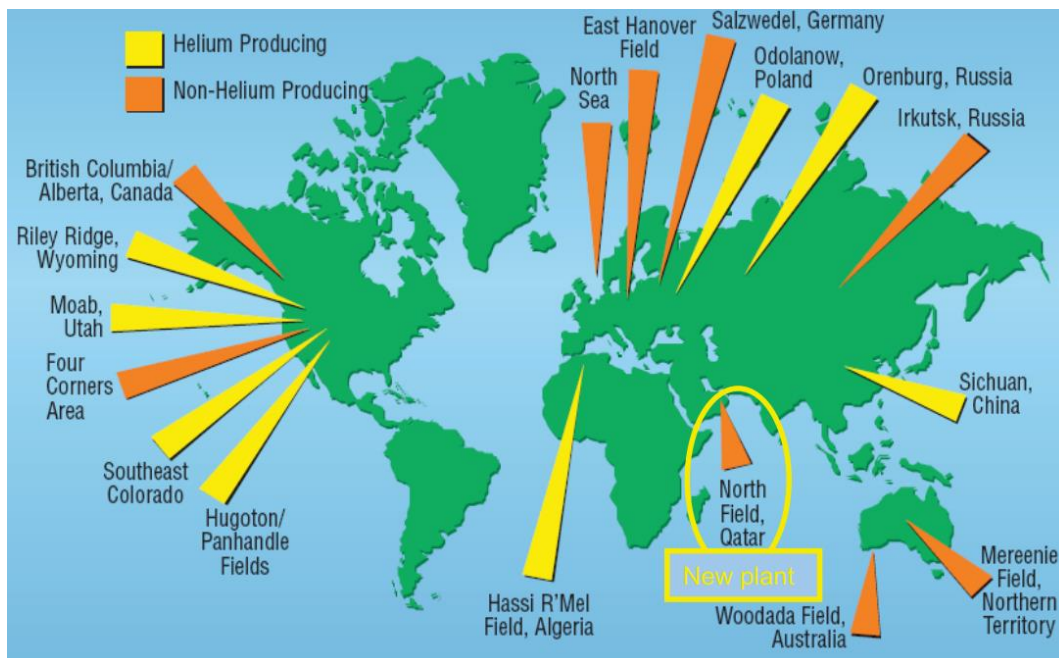

Figure 3.11: Helium production facilities which use natural gas (Chrz, 2010).



### 3.4.2 Non-hydrocarbon sources (NHS)

Most of the helium produced worldwide is a by-product of natural gas (methane) production. It is estimated that NHS sources constitute insignificant fractions (~3%) of global helium supply now but could become an increasing helium source in the market in the future (Danabalan, 2017).

NHS source exploration and production activity has been concentrated in the Four Corners area of Southwestern USA (Kansas, Oklahoma, Colorado, and Texas) and in Southwestern Saskatchewan, South Eastern Alberta and Northern Montana. Another helium production site is in Tanzania. One example of an NHS plant is the Doe Canyon helium plant (Figure 3.12). This plant is unique, as it extracts helium from a naturally occurring underground carbon dioxide (CO<sub>2</sub>) gas source.



Figure 3.12: Doe Canyon Helium Plant (Air Products' Doe Canyon Helium Plant, 2016).

The plant facility uses a novel process to produce pure helium from the CO<sub>2</sub> stream that contains recoverable amounts of helium. The helium extraction procedure is illustrated in Figure 3.13. The purified helium is liquefied on-site prior to delivery to the customers.

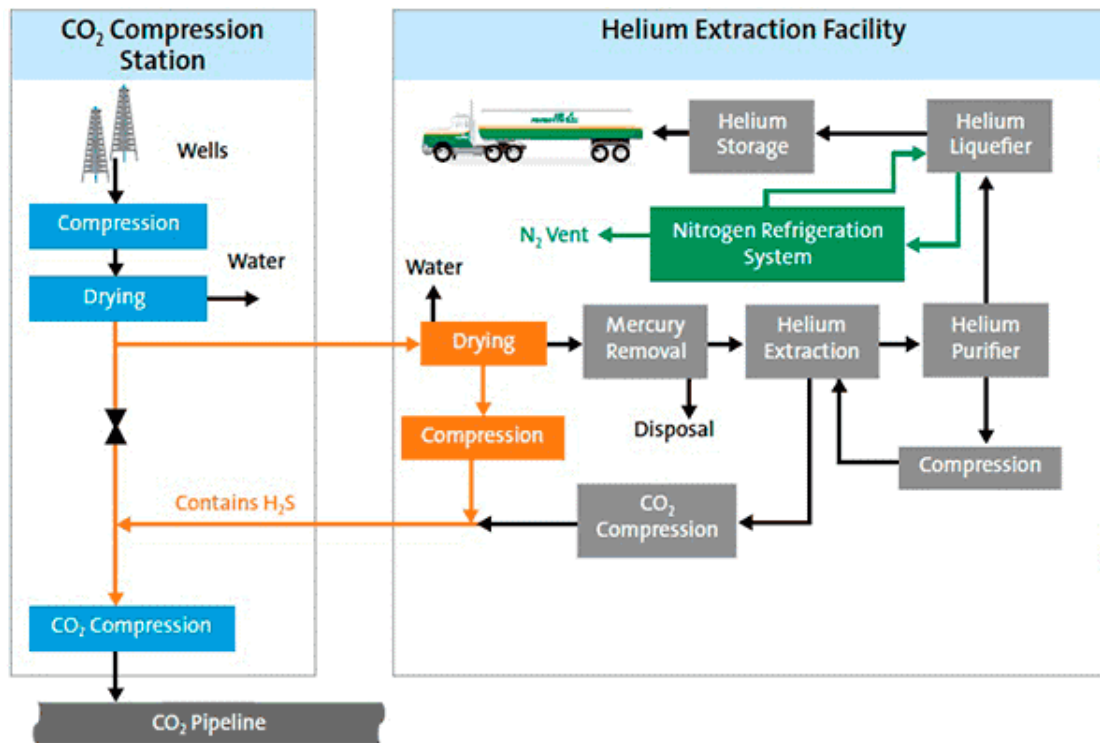

Figure 3.13: Helium extraction process from NHS\_(Air Products' Doe Canyon Helium Plant, 2016).

### 3.4.3 Helium transportation

Liquid helium is transported long ways around the world and it is a truly global gas. The ISO size helium transportation container holds about 41 640 L of helium at 6 bar pressure. The container can store helium up to 45 days with no-loss-operation at 10% ullage, 5 W heat leak, consumption of LIN < 30 kg / 24 h. Liquid helium (LHe) is typically sold in dewars (up to 1,000L) or bulk ISO containers (41 640 L), gaseous helium (GHe) is sold in tube trailers/skids (up to 5100 L) or high pressure (HP) cylinders, end users usually buy products under long-term contracts.

Figure 3.14 describes the helium supply chain structure. It shows that compressed and liquid helium is sold in bulk first and later distributed to the end users. The diagram shows the supply chain and the main actors in the helium production and distribution business.

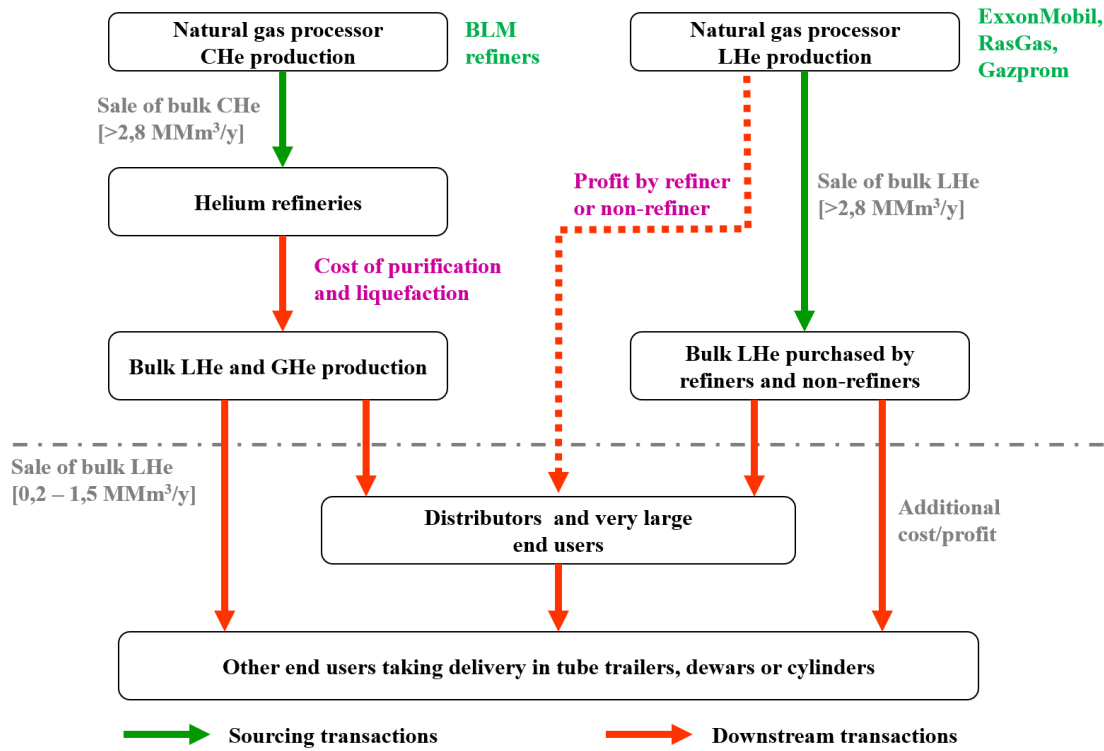

Figure 3.14: Helium supply chain structure (Chrz, 2010).

Figure 3.15 Illustrates helium logistics and various forms and methods of helium delivery to customers.

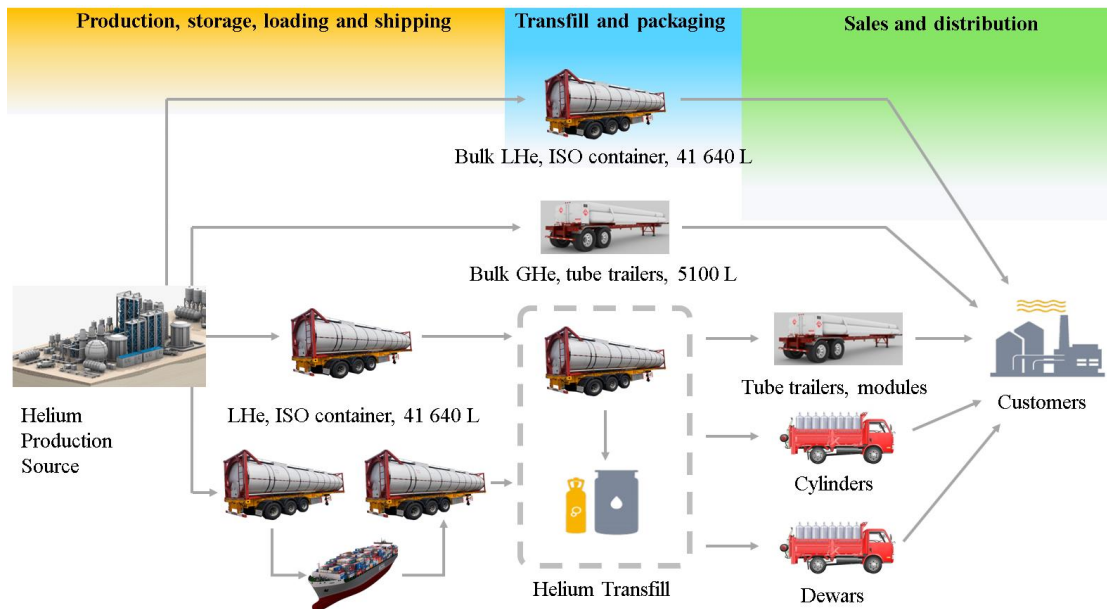

Figure 3.15: Helium logistics (Chrz, 2010).

Helium is transported in a variety of ways: ISO containers, high pressure tubes, cylinders, and dewars (Figure 3.15).



Figure 3.16: Small-volume helium storage containers. (a) Cylinders of gaseous helium. (b) Dewars of liquid helium (National Research Council, 2010).

Liquid helium gas is transported in special vacuum insulated containers, commonly 41 600 litres in volume, Figure 3.17. Liquid helium transportation containers are high tech design special units. The container is made of four different shells. The inner vessel containing liquid helium is made of stainless steel. The second shell is the helium shield where a small portion of the evaporated cold helium cools the shield to intercept radiant heat transfer into the inner tank.

The container has a separate liquid nitrogen tank consisting of about 1000 L  $-196^{\circ}\text{C}$  liquid nitrogen gas that also intercepts some of the heat being transferred from the outer shell. The fourth, and outer shell is made of stainless or mild steel. An aluminium foil wrapping between all the shells is used to block heat transfer into the inner vessel via reflection. Finally, a good vacuum with a pressure level lower than 1 microbar (equals 2 km of normal wool insulation) is pumped between the shells. The foil reflects the radiant heat and the wool minimizes heat transfer by conduction. The inner tank is supported by stainless steel support rods from the outer shell. These are very thin metal and filled with a low heat conducting but load bearing material. This unique construction maintains the helium in liquid form in the container for 6-7 weeks below the safety valve level which is normally 6bar.



a

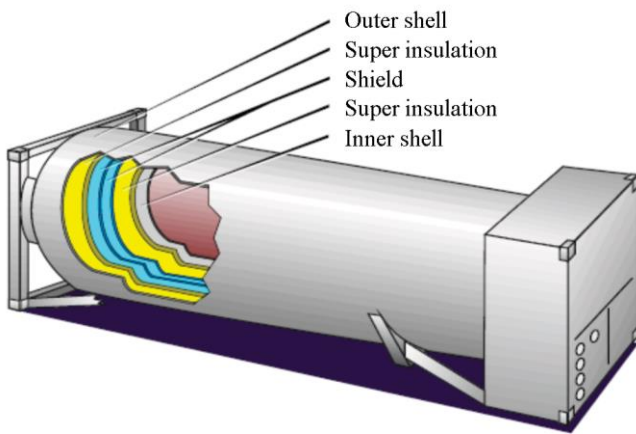

b



c



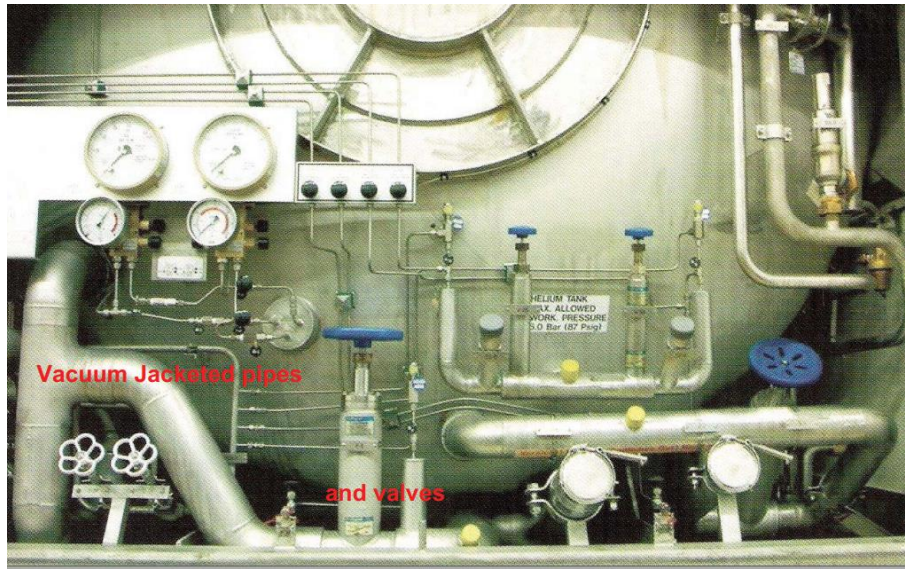

d

Figure 3.17: Liquid helium ISO transportation container. (a) ISO container mounted on a truck. (b) ISO container structure. (c) ISO container prepared for shipping by sea. (d) ISO container operation cabinet (Gardner Cryogenics US).

### 3.5 Helium recovery from MRIs

Helium recovery systems have been developed during the last two decades. The first recovery systems were built for pure helium applications, e.g., MRI (Magnetic Resonance Imaging) in research centres as university cold labs and large capacity MRI units in hospitals. The impure helium is collected from the exhaust pipe of the MRI and compressed into high pressure cylinders, bundles or cylinder containers which are delivered to the helium liquefaction plant where the impurities (moisture, oxygen and nitrogen) are removed, the helium molecules re-liquefied and the recycled and liquefied helium is delivered back to the customers (Korjala, et al., 2017). Figure 3.18 is the schematic flow diagram of this kind of recovery system.

The purification of purely gaseous helium is also an option for recycling. The compressed gas containers are delivered to the purifying process. Normally this kind of gas contained in the MRI system exhaust line includes about 2% impurities (mainly moisture and air ( $N_2$  and  $O_2$ )). The moisture is removed by a dryer unit, and the air is purified in a molecular sieve unit or in a liquid nitrogen trap unit. The purifier units can be located at the end user site. The gas is analysed before it is delivered to the next process which can be any application requiring helium, including welding.

The significant advantage of recovering and recycling the helium from the MRI exhaust line is its pureness. The removal of the impurities (normally about 2%) is quite simple and easy to carry out.

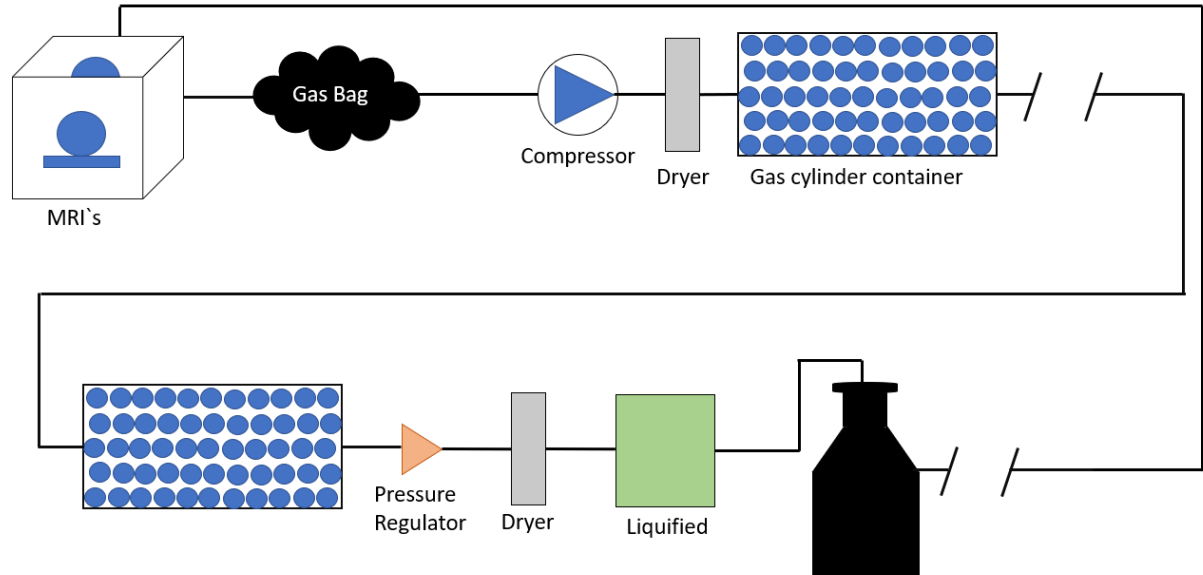

Figure 3.18: Helium recovery system in MRI use.

In the large particle accelerators such as CERN, and in research centres working with MRIs and super conductive magnetic systems using large volumes of liquid helium the evaporated gas is recovered, purified, and liquefied on site, Figure 3.19. The recycling efficiency is high and economic.

The environmental aspects are high considerations when utilizing recovering systems. The MRI helium recovery and recycling systems present a good example. When helium is reused with the recycling rate exceeding 80%, which is feasible in big MRI or super conductive magnetic systems, the green effect and effect on CO<sub>2</sub> emissions are remarkable. This example encourages operators to discover new ways of recovering more helium from different applications.

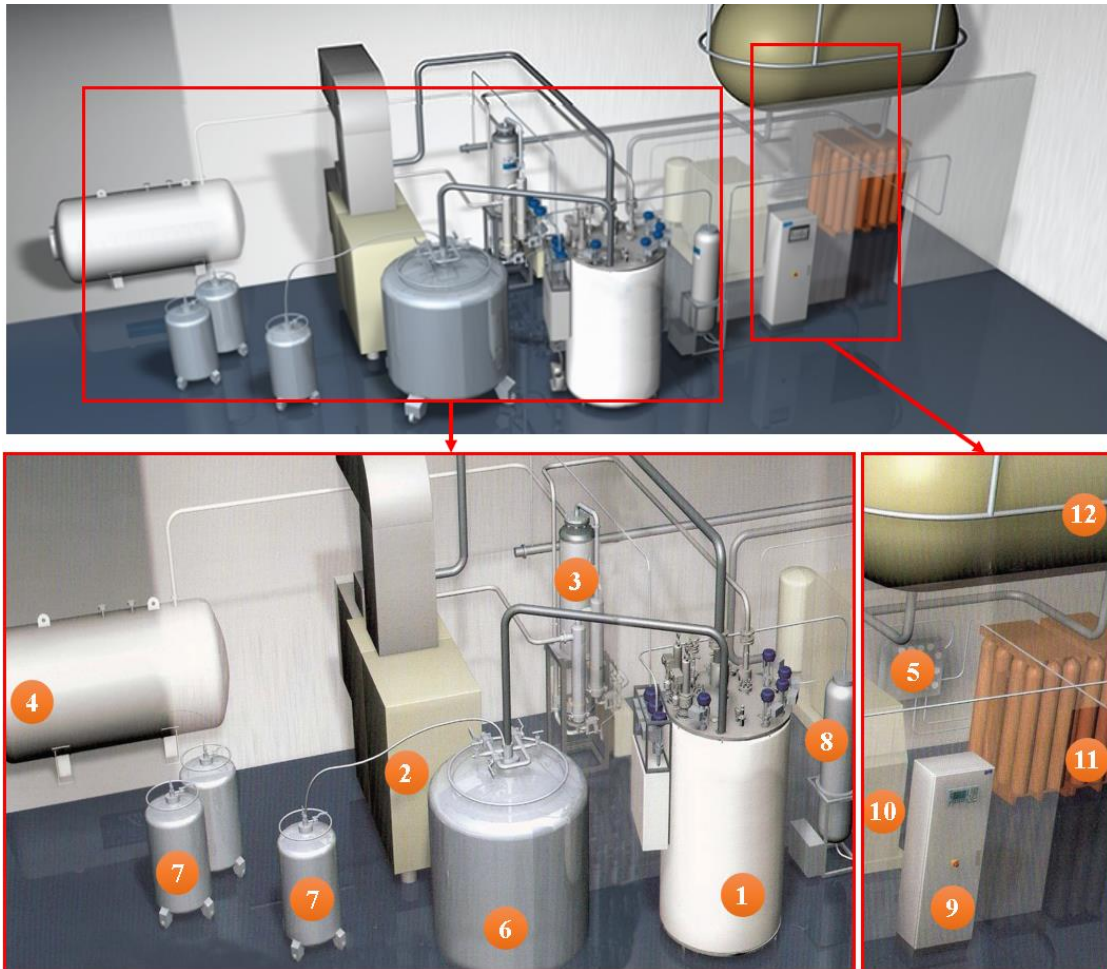

Figure 3.19: Helium On-Site Recovery System for large volume helium users. Where 1 – liquefier; 2 – Compressor; 3 – Oil removal system; 4 – Buffer tank; 5 – Pressure control panel; 6 – Dewar; 7 – Mobile dewar; 8 – Line drier; 9 – Stand-alone control panel; 10 – H.P. recovery compressor; 11 – Cylinder bundle; 12 – Gas bag (Anon., 2019).

### 3.6 Cost structure of helium

Helium is sold in both liquid and gaseous form. Main applications for liquid helium include MRI and superconductive devices and research projects. Gaseous helium is available in different grades: balloon grade, purity 97...99 %, N46 grade (99,996 %), N50 and up to N60 qualities, the higher the level of purity, the higher the price. In welding applications, N46 helium quality is sufficient. The cost structure of helium varies in different parts of the world. Traditionally helium use in the US has been quite broad, also helium is used extensively in low temperature technology applications due to its good availability thanks to large production plants in the Kansas area. The price of helium in USA has been reasonable. In Europe, the price of helium has always been higher because of the long transportation distances and minimal own sources. Due to globalisation the



helium market has harmonized. The rapid growth of Asian economies has increased the demand of helium relatively more in Asia than in Europe and the USA (Korjala, et al., 2017).

The cost structure of helium is dependent on the production volumes and the market demand. One of the biggest players on the price indication has been and continues to be the Bureau of Land Management (BLM) an agency of the US department of the Interior. The BLM is America's largest landowner, managing 1 044 089 square kilometres of federal public domain in 12 western states, including Alaska. It is also the administrator of 2 832 800 square kilometres of sub surface federal mineral estate (e.g. oil, gas, coal, and helium) throughout the US. BLM controls 45% of the US supply and 30% of the helium supply in the world. This helium derives from the Cliffside gas field in the states of Kansas, Wyoming, Oklahoma and Texas, Figure 3.20. As can be seen, the crude helium pipeline system is several hundred kilometres long. Helium refineries that purify and liquify the helium locate along the pipeline. The main activity in the area is the production of natural gas, and as an impurity in the natural gas, helium is extracted in the same plants.

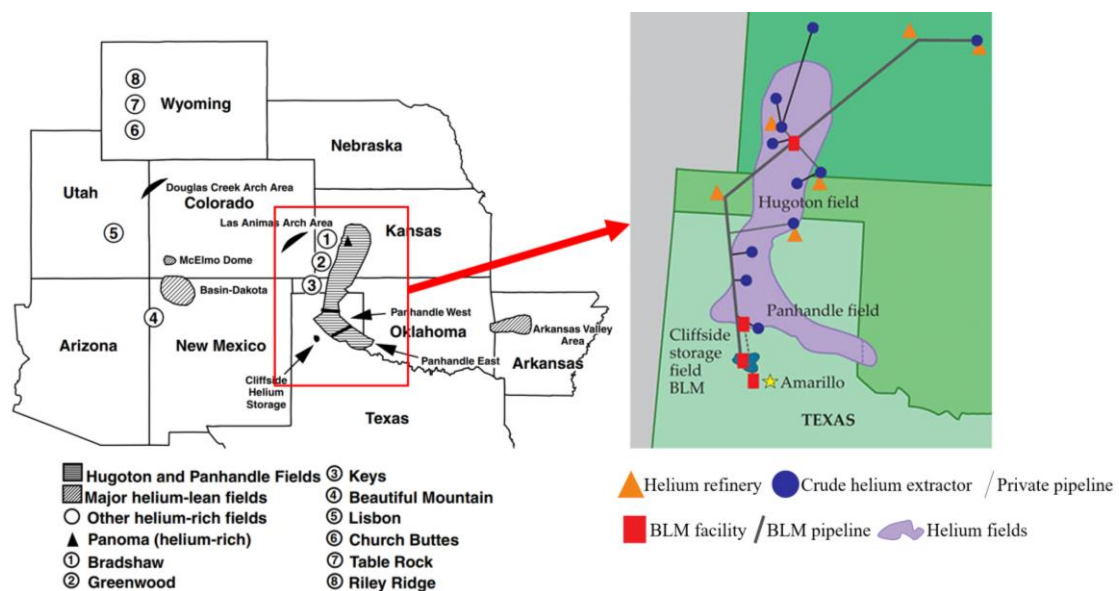

Figure 3.20: Primary helium sources and plants in the US Kansas, Oklahoma and Texas area (BLM, USA).

Helium is considered a strategic resource of the US and thus the national helium program commenced in 1960 by an Act of Congress. The program was managed by BLM, which supplied helium to NASA, the US Air Force, the department of energy, national institutes of health and several national laboratories and universities in the US. The program was cancelled by Congress in the late 1970s but private companies owning helium recovery plants were permitted to continue production of crude (60%) helium. They were given access to the pipeline and gas reservoir owned by the BLM. The helium in storage consisted of that bought by the government during the program operation and the gas

stored and owned by the private companies. In 1996 the US Congress passed the Helium Privatization Act opening the market to private companies to utilize the helium resources in the US. BLM releases a certain amount of crude helium (crude helium comprises 50...70 % helium) annually and determines the price per square meter. BLM organized public auctions for selling a certain volume of helium. The government annually auctioned portions of their helium until the final auction was in 2018. It is evident that crude helium sold by BLM has been significantly under-priced relative to the bulk LHe open market value, Figure 3.21.

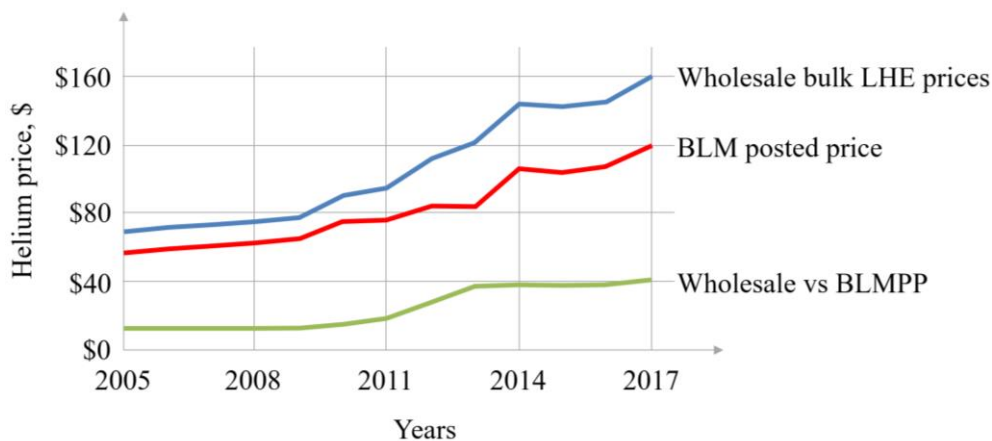

Figure 3.21: BLM crude helium price level USD/28.3 m<sup>3</sup> (1000 scf). Prices are indicated as of 1<sup>st</sup> October yearly (Helium One, 2020).

This price indication is public and the companies who want to purchase the government owned helium can make a contract with BLM and buy a certain amount of crude helium consisting 50-70 % of helium at each yearly option. Crude helium must be purified and liquefied before taken into use and therefore gas companies have built up their own purification and liquefaction plants in the Kansas area. The global helium price has mainly followed the indication level set annually by BLM.

Other helium sources around the world are mostly owned by big energy companies. The share of the helium business in the total turnover of these energy companies is minimal, therefore interest in utilising the sources is not strong and active. Compared to the global helium prices the price level in Europe is higher due to long transportation distances and shortage of the product. The demand for helium has often been higher compared to the production capacity. This has increased the helium price, as can be seen in Figure 3.22, which indicates price dynamics for helium grade A during the last decade.

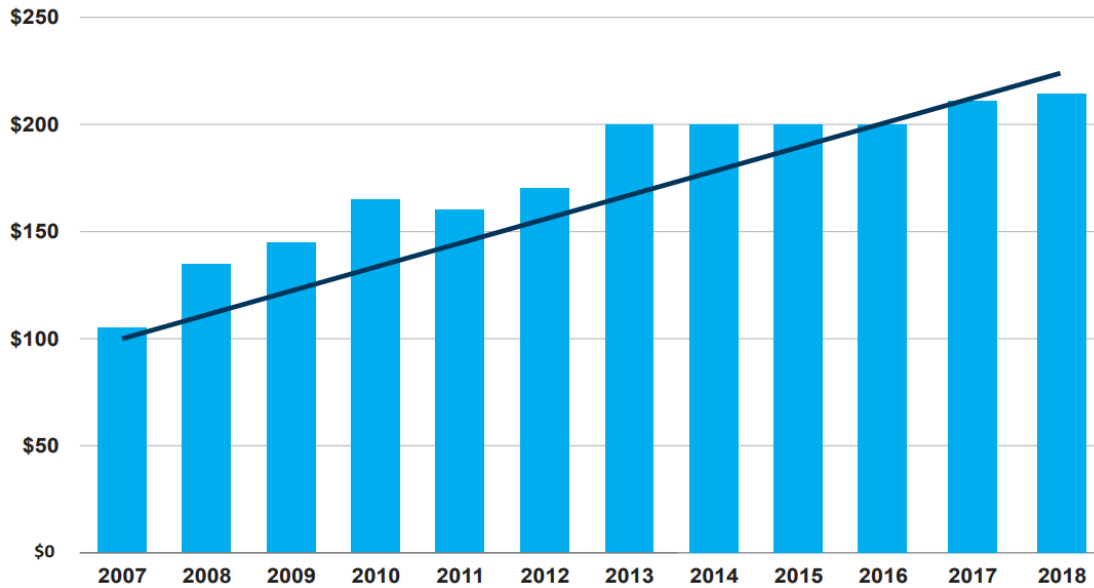

Figure 3.22: Grade A helium price chart, Mcf (Wilson, 2019).

During the last 8 years the helium market (production versus demand) has been very volatile, for three years, 2011-2013, the shortage was severe. Probable reasons for this were the decline of the BLM System and crude helium allocation to the helium refiners, extended outages of big suppliers such as Exxon Mobile in the US and in Qatar. The result of this was the doubling of prices and a significant decrease in demand (about 10%) because helium could not be afforded in use and thus other applications were used.

During 2014-2015, there was a significant oversupply because new production plants came on stream or were expanded in Qatar, Algeria, and Russia. The growth in demand was negligible and prices were reduced by 15-20%.

From the beginning of 2016 to the middle of 2017 the helium markets found an equilibrium, demand grew slight and prices stabilized.

From the middle of 2017 the situation on the market tightened up and since February 2018 there has been a shortage of supply. The reason for this is the allocation of all major producers due to the production difficulties (availability in the US declined because of the BLM depleting and technical failures in plants).

In 2020 the Covid-19 pandemic has affected the helium market. The industrial production activity has decreased, also the requirement for helium is less. This has balanced the production/demand temporarily.

The situation on the helium market during 2011-2020 clearly demonstrated that confidence in the availability and the predictability of long-term pricing development are challenges in helium use. This affects the customers and the use of applications requiring

helium. Therefore, the recovery and recycling of helium in all possible applications is necessary.

In the long term, consumption of helium has gradually increased as shown in Figure 3.23. The severe shortages during 2011-2013 show instability in the demand but the estimate still shows an approximate 3% annual growth from now onwards.

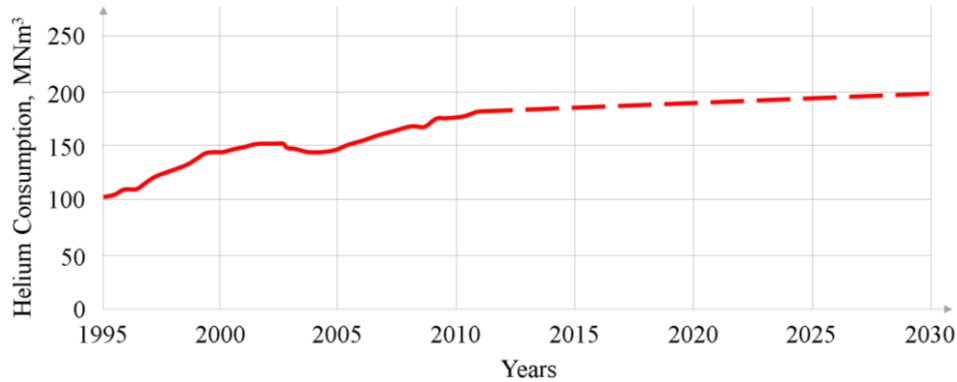

Figure 3.23: Worldwide helium consumption from 1995 to 2030 (Helium One, 2020).

Charts below indicate the helium market production, demand (Figure 3.24), projected market growth by region (Figure 3.25) and consumption by region (Figure 3.26).

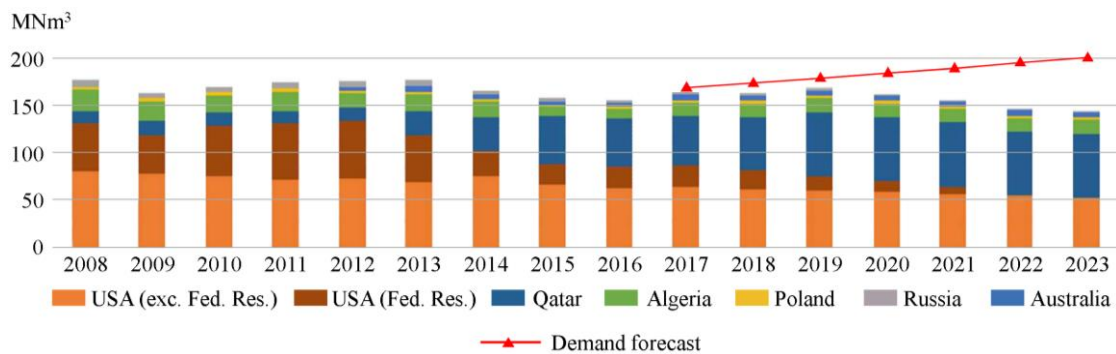

Figure 3.24: Global helium production and demand forecast (Helium One, 2020).

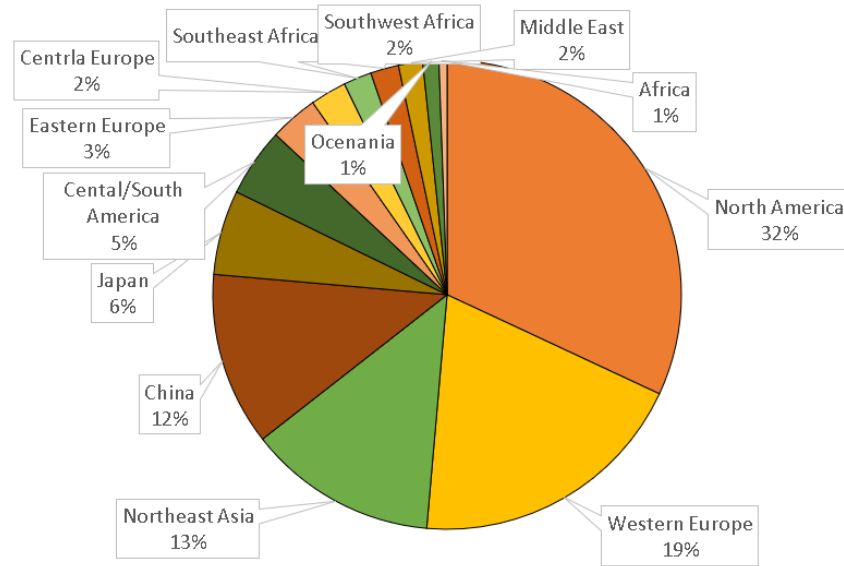

Figure 3.25: World consumption of helium, 2018 (IHS Markit, 2019).



Figure 3.26: Projected helium market growth rate by region, 2019-2024 (Mordor Intelligence, 2019).

The helium used in Europe mainly comes from Algeria and Russia, also partly from Poland, the US and Qatar. Welding applications made up only 17% of the total helium consumption throughout the world in 2018. The exact figures on the European helium use in welding application are not available but the estimate is about 10%. The low percentage is mainly due to the high price, but the development of advanced welding processes has raised the need to apply the most effective shielding gases and helium has much potential in increasing the efficiency in gas arc welding.

### 3.7 Applications of helium

Helium is essential in various medical, laboratory and manufacturing applications. In some applications helium has been traditionally used for decades and novel applications are arising where the use of helium is required. The total use of helium in 2019 was estimated to be about 170 000 000 m<sup>3</sup> and the production to be at the same level. The global helium market is estimated to be \$5 - \$6B in US dollars. The market value has increased due to recent pricing actions. At the current consumption rate, the reserves should suffice for about 220 years (Mordor Intelligence, 2019).

Most helium (20%) is consumed by MRI (Magnet Resonance Imagery) devices and other applications in laboratories (10%), such as particle accelerators; Maglev trains; and other materials research applications. It is also used in cryogenic industry as a coolant because liquid helium is the coldest substance. The second most popular application of helium is arc and laser welding and cutting (17%), for example in GMAW with a solid wire (direct current, electrode positive); TIG, where helium is used as an inert-gas atmosphere for welding metals such as aluminium; plasma welding (direct current, electrode negative). Helium is utilized for creating controlled atmospheres (10%) for applications such as heat treating, metals refining, nuclear reactors, optical fibre fabrication (6%), semiconductors and lasers. The lifting industry utilizes helium (8%) for blimps, military/border surveillance, telecom, cargo ships, in meteorology (as a lifting gas for instrument-carrying balloons), party balloons, and airbags. Purging and pressurizing applications require helium for aerospace (rocket propulsion, especially those for liquid hydrogen, because only helium remains gaseous at liquid-hydrogen temperature) and automobile air bags (6%). Another common application of helium is leak detection (5%), where it can be used for refrigeration, automotive, aerospace, pipelines, and vessels. Furthermore, helium is used as a component in high-pressure breathing mixtures (3%), where it is mixed with oxygen, as in scuba diving. Use of helium is particularly beneficial in the breathing mixtures because helium has low solubility in blood. Furthermore, meteorites and rocks have been analysed for helium content as a means of dating (Ramsay & Soddy, 1903). Figure 3.27 illustrates worldwide helium use by applications in 2018.

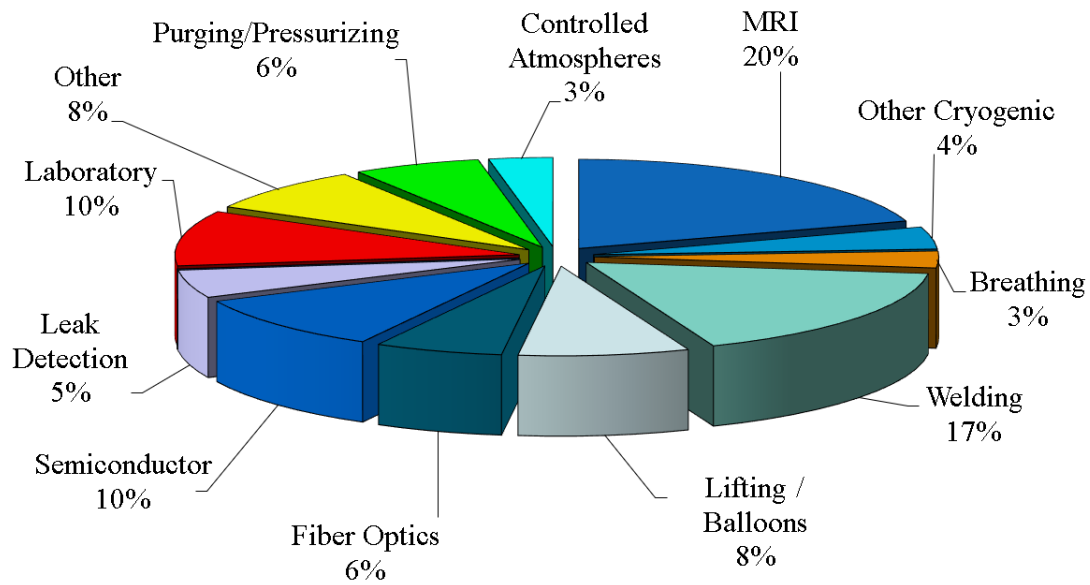

Figure 3.27: Worldwide helium use by applications in 2018 (Saudi, 2017).

In recent years, several novel applications of helium have emerged. Most noticeable increase in helium consumption is probably in the aerospace and lifting industries. Strong activity related to privately funded space companies and their rocket launches (Space X, Blue Origin, and others). Space-X has been especially aggressive in trying to ensure sufficient helium supply to support their ambitious launch schedule. Google's Project Loon is a very bold project to employ balloons to provide Internet access to the World's remote territories. Additionally, increased helium consumption is stimulated by the renewed interest in using airships for transportation of cargo to/from remote areas.

Space X uses helium in the propellant tank of the rocket at three different levels of available fuel, as illustrated in Figure 3.28.

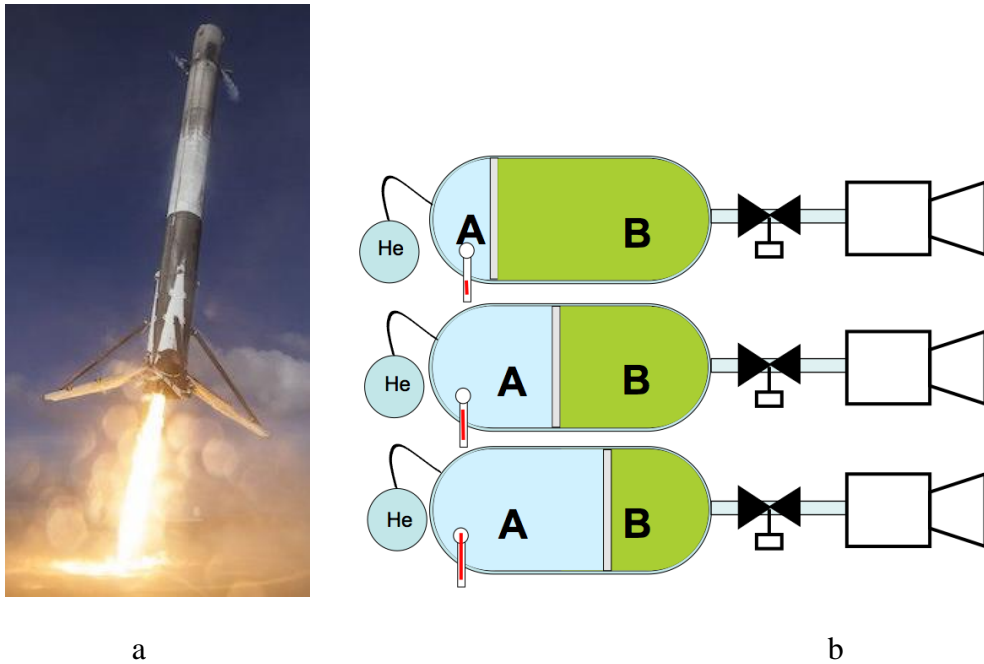

Figure 3.28: Helium use in private space companies. (a) SpaceX rocket. (b) Rocket propellant tank structure (Williams, 2019).

The airtight tank is constructed to carry the green part. As the green substance is used, under normal condition, the pressure and temperature would decrease, but the volume would remain constant. But this green substance shall be used in some way in a specific state and at a certain temperature. This situation can be fixed by artificially changing the volume to keep the pressure and temperature constant, as the green substance decreases in amount.

The inert gas is pumped into section A. Since the pressurant tank is at a much higher pressure than the propellant, when a valve between the pressurant and the propellant tank is opened, pressurant will flow from the high-pressure section to the low-pressure segment, pushing on the piston, bladder, or propellant itself. Opening another valve between the propellant and the engine will cause propellant to flow from the high-pressure propellant tank to the lower pressure engine. In addition to assisting with fuel flow, the helium pressurization systems maintain the structural integrity of the rocket, because the tank walls of rockets are very thin.

In recent years, several Maglev train projects have been designed and their construction has begun in China, the U.S., and other countries. Maglev trains utilize either helium or nitrogen gas for cooling the magnets.

Helium comes in different grades depending on purity. Typically, helium grades used for welding applications are Grade 5.5 (99.9995% purity), Grade 4.7 (Grade A, 99.997% purity) and Grade 4.6 (99.996% purity).



## 4 Helium as a welding shielding gas component

Helium is more expensive than other gases because its limited availability and more difficult production. This also means that helium and helium additions are mainly used where special advantages are required. Helium can be used with all metals. It is normally used in mixtures and seldom as a single gas. In contrast to argon, helium is difficult to ionize and its arc ignition is poor. The heat conductivity is much higher compared to argon. The arc voltage is much higher than with argon, therefore the heat input is much higher at the same arc current. The arc is less concentrated which gives a wider and deeper penetration. Hot cracking and porosity are more easily avoided. The wetting of the surface is better. This gives a lower reinforcement and less risk of undercut. Helium has a low density and mixtures with high helium content possess a weaker shielding effect compared to argon. A higher gas flow rate must be used.

Helium, like argon, is an inert gas. It delivers more heat input to the joint. Mixed with argon it increases welding speed and is advantageous for the penetration in thick-walled aluminium or copper where it compensates for the high heat conduction. Drawbacks of helium include high cost and low density.

As a shielding gas in welding processes, helium is an important gas and has many advantages. Selection of the most suitable shielding gas and the optimal delivery method and flow into the arc have significant impact on the productivity of the welding.

Helium also affects to important elements of the welding process:

- Arc and metal transfer characteristics
- Fusion zone width
- Welding speed
- Weld penetration
- Surface shape patterns
- Undercut tendency

Gas mixtures is the main area of helium use. The arc temperature is higher when helium is mixed with argon, oxygen or CO<sub>2</sub>. The pool temperature is more controlled, wetting increased and the arc better stabilized. The higher the helium content the higher the arc voltage and the greater the heat output. It is used in gas mixtures for aluminium and nickel and is applicable to stainless steels with helium-argon-oxygen or CO<sub>2</sub> mixtures. Helium-argon mixtures are also used for the welding of 9% nickel steels.

Table 4.1: Recommended GMAW gases and gas mixtures for various metals and alloys (Davies, 1996), (Jeffus, 2012).

<b>Metal type</b>	<b>Gas shield</b>	<b>Remarks</b>
Carbon and low-alloy steels	CO <sub>2</sub>	For dip transfer, and spray transfer. Spatter problems. Use deoxidized wire. Least expensive gas, provides deep penetration.
	Ar + 15 – 25% CO <sub>2</sub>	For dip or spray transfer. Minimum spatter and smooth weld surface. Reduces penetration with short-circuiting transfer.
	Ar + 5% CO <sub>2</sub>	For dip and spray transfer. Pulse spray and short-circuit transfer in out-of-position welds.
	Ar + 10% CO <sub>2</sub>	Pulse spray and short-circuit transfer in out-of-position welds. Wider, more fluid weld pool.
	Ar + 5% O <sub>2</sub>	Spray transfer. High impact properties
	Ar + 5% CO <sub>2</sub> + O <sub>2</sub> 2%	For pulsed arc and thin sections. All metal transfers for automatic and robotic applications
	He + 7,5% Ar + 2,5% CO <sub>2</sub>	Excellent toughness; excellent arc stability, wetting characteristics, and bead contour; little spatter with short-circuiting transfer
Stainless steels	Ar + 1 – 2% O <sub>2</sub>	Spray transfer, oxygen provides arc stability
	Ar + 25% CO <sub>2</sub>	Smooth weld surface, reduces penetration with short-circuiting transfer
	Ar + CO <sub>2</sub> + N <sub>2</sub>	All metal transfer, excellent for thin gauge material
	He + 23.5% Ar + 1.5% CO <sub>2</sub>	High quality dip transfer. For thin sections and positional work.
	He + 24% Ar + 1% O <sub>2</sub>	Good profile
	He + 7,5% Ar + 2,5% CO <sub>2</sub>	Excellent toughness; excellent arc stability, wetting characteristics, and bead contour; little spatter with short-circuiting transfer

	CO <sub>2</sub>	Least expensive gas, provides deep penetration with short-circuiting of globular transfer.
Aluminium and its alloys	Argon	Stable arc with little spatter, provides spray transfer
	Helium	Extremely hot arc for welds on thick sections, less pre-heat, more spatter
	He + 25-75% Ar	Stable arc, highest heat input. Good penetration. Recommended for thicknesses above 16 mm.
Magnesium and its alloys	Argon	Stable arc, provides spray transfer
	He + 25-75% Ar	Hotter arc. Less porosity
Copper and its alloys	Argon	For sections up to 9.5 mm thickness, provides spray transfer
	Nitrogen	Provides high heat input with globular transfer
	Helium	Hot arc for welds on thick sections
	He + 25-75% Ar	For medium and heavy sections. High heat input
Nickel and its alloys	Argon	Sections up to 9.5 mm thickness. Pulsed arc
	He + 25-75% Ar	High heat input, less cracking in thicker sections of 9% Ni
Cupronickel	Argon	Stable arc, provides spray transfer
	Ar + 30% He	Stable arc with less cracking risk
Titanium, zirconium and alloys	High purity argon	Very reactive metals. High purity shielding gases are essential

Table 4.2: Shielding gases for TIG welding for various stainless steels (Jeffus, 2012).

	Austenitic Stainless Steel	Duplex Stainless Steel	Super-duplex Stainless Steel	Ferritic Stainless Steel	High-alloy austenitic stainless steel	Nickel alloys
Ar	x	x	x	x	x	-
Ar + He	x	x	x	x	x	x <sup>1)</sup>
Ar + 2-5% H <sub>2</sub>	x <sup>2)</sup>	-	-	-	x <sup>2)</sup>	x <sup>2)</sup>
Ar + 1-2% N <sub>2</sub>	-	x	x	-	-	-
Ar + 30% He + 1-2% N <sub>2</sub>	-	x	x	-	-	-

1) - Improves flow compared with pure Ar; 2) - Preferably for automatic welding. High welding speed. Risk of porosity in multi-run welds.

The normal gas for TIG welding is argon. Helium can be added to increase penetration and fluidity of the weld pool. Argon or argon/helium mixtures can be used for welding all grades.

## 4.1 The affecting properties of helium in welding

### 4.1.1 Gas density and molecule size

Helium has extremely low density, 0.178 kg/m<sup>3</sup>, compared to the other main shielding gases. Argon gas density is 1.784 kg/m<sup>3</sup> and carbon dioxide 1.977 kg/m<sup>3</sup>, so helium density is over ten times lower. The density of air is 1.293 kg/m<sup>3</sup> which is about seven times higher than helium density. This accounts for a higher helium flow to protect the arc and the weld pool from the effects of air and the moisture in it during the shielding operation. The size of the helium molecule is small and the molecules are quick in their movements. This feature combined with the low density improves the spread of metallic vapours easily all over the arc.

Figure 4.1 describes the shielding gas flow variations with different amounts. It is important to determine and use the correct amount of flow. If the flow is too low the shielding is deficient and if the flow is too high the air is mixed into the turbulent flow, creating impurity problems to the arc and weld pool. The extra flow uses too much gas, increasing costs (Konishi, et al., 2016).

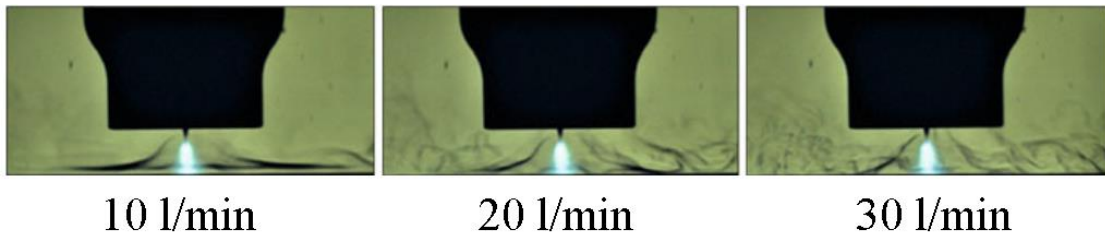

a

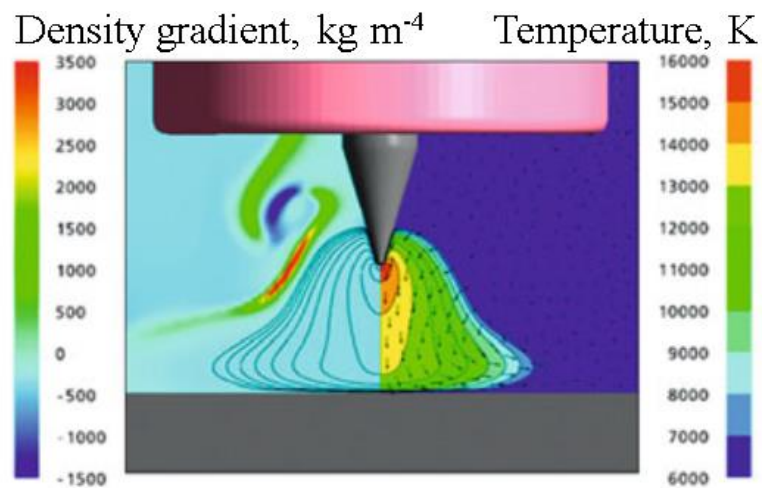

b

Figure 4.1: Shielding gas patterns during TIG welding. (a) Schlieren picture at vertical aperture with different gas flow speeds. (b) CFD simulation results. Modified from (Konishi, et al., 2016).

Figure 4.2 describes the flow characteristics in a GMAW gas distribution path. The simulation picture is made with argon which is a ten times denser gas than helium. A special design for achieving less turbulent flow characteristics is required when helium is used (A. Traidia, 2011).

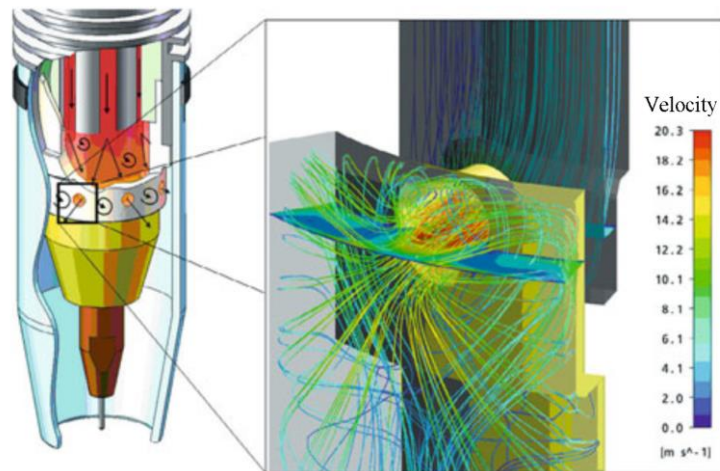

Figure 4.2: GMAW torch flow characteristics of shielding gas (10 l/min, Ar). Modified from (A. Traidia, 2011).

#### 4.1.2 Ionization energy

The ionization energy of helium is high, 24.6 eV, compared to other shielding gases. With argon it is 15.8 eV and carbon dioxide 14.0 eV. The high ionization energy means difficult ignition of the arc and a lively cathode point results in an unstable arc. The required degree of the welding arc ionization is 5-30% for conducting the welding current. The arc seeks the lowest possible temperature which accommodates sufficient electrons for ignition to take place. At ionization, the created metal vapours cause difficulties to the ignition and even a small amount of metal vapour in an inert gas plasma will perturb the thermal-electrical properties of the plasma.

#### 4.1.3 Thermal conductivity

Helium has a high ionization energy. Therefore, the ignition of the arc is difficult, and the cathode point is lively, resulting in an unstable arc. The low density of helium leads to the spread of the metallic vapours all over the arc. Helium has good thermal conductivity and thus is most advantageous in automated welding processes applied in high productivity applications where high welding performance is required. Helium increases the arc voltage, raising the welding speed to the highest possible and helps to remove the arc gases pre-solidification, thus decreasing porosity. The shielding effect of helium is weaker compared to e.g. argon-based shielding gases because helium has such a low density. Achieving the same shielding effect requires a much higher flow of helium. Helium is more sensitive to voltage fluctuations during welding.

The shape of the penetration when using helium is quite wide and flat due to the helium properties: low density, and high ionization energy. The weld shape for different shielding gas compositions are shown in Figure 4.3. Additionally, metal transfer appearance and the weld penetration shape are similarly shown in Figure 4.4.

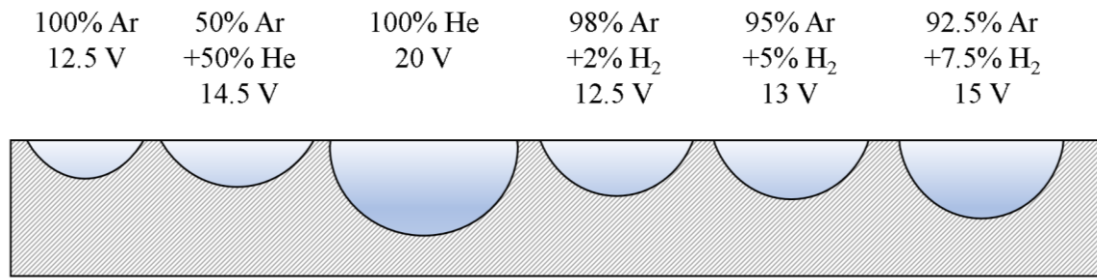

Figure 4.3: The penetration and arc voltage in stainless steel welding. Steel: 304 Sheet: 5 mm, Welding current amperes: 130 A, Arc Length: 4 mm, Welding Speed: 15 cm/min (Lukkari, 2006).

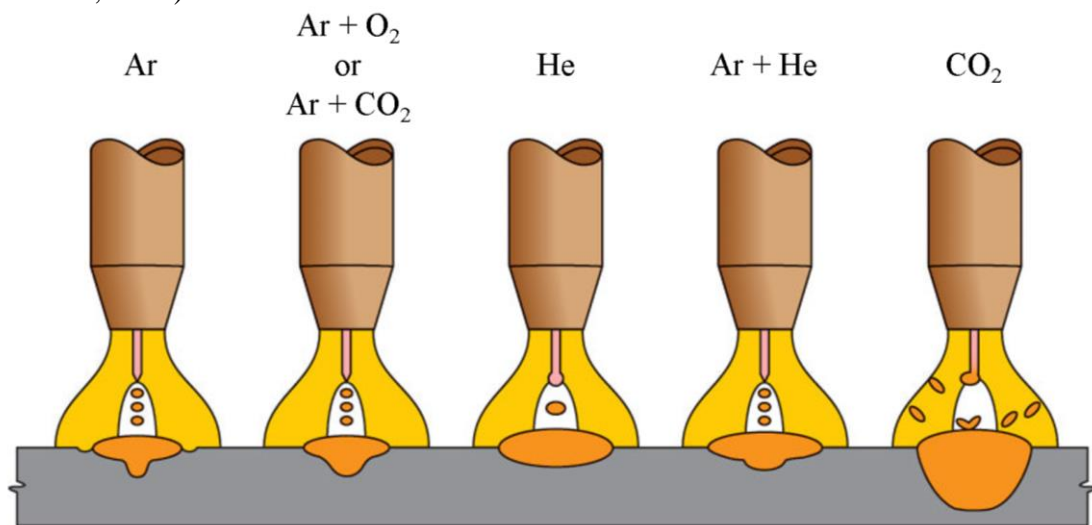

Figure 4.4: The effect of the shielding gas on penetration (Blondeau, 2008).

#### 4.1.4 Influence on wetting properties

Wetting is the phenomenon whereby a liquid filler metal or flux spreads and adheres in a thin continuous layer on a solid base metal; or the ability of the filler metal, when molten, to spread over and connect the joint surfaces (the substrate), Figure 4.5 (Praxair Direct, 2019).

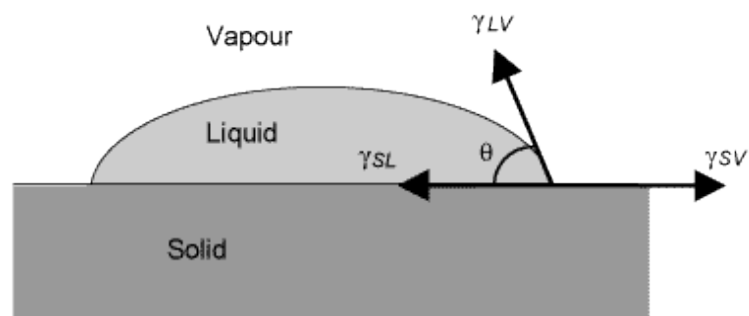

Figure 4.5: Diagram showing the relationship between the three surface tensions (surface free energies) for a droplet of liquid resting on a solid substrate at the three-phase point (TWI Global, 2019).

Surface tensions are represented by the symbol  $\gamma$ , and the subscripts L, S and V stand for liquid, solid and vapour. The surface tensions can be combined with the equilibrium contact angle,  $\gamma_{LV} \cos \theta$ . The smaller the contact angle, the better the wetting.

Shielding gas has a strong effect on wetting properties. Helium, when used as a shielding gas, facilitates the reduction of surface tension and viscosity, as the temperature of the welding arc is higher. Shielding gases such as  $\text{CO}_2$  and  $\text{O}_2$  can improve wetting by oxidation. Figure 4.6 compares helium to argon shielding properties and their effect on wetting properties.

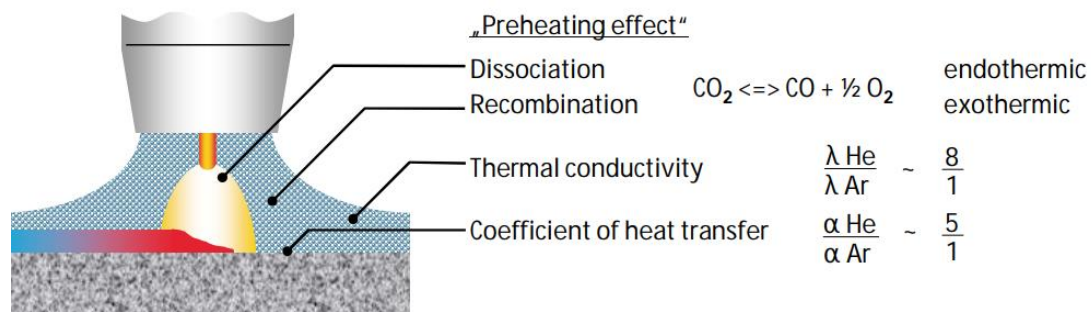

Figure 4.6: Influence of welding gas components on wetting properties (Sarma, 2014).

### Shielding Gases for Spray or Pulsed-Spray Transfer

Pure argon shielding is used on all metals except ferrous metals such as mild steel and stainless steel. Argon shielding gas or mixtures of argon and other gases are required for the axial spray transfer process. Common argon shielding gas mixtures used for steel contain helium and/or oxygen. Helium/argon mixtures may contain as much as 80% helium. The helium is added to the argon to increase the power in the arc without affecting the desirable qualities of the spray mode. With more helium, the transfer becomes progressively more globular, forcing the use of a different welding mode, to be described later. Since helium and argon gases are inert, they do not react chemically with any metals. The cathodic cleaning action associated with argon at DCEP is also important for welding metals such as aluminium. Aluminium forms a heavy undesirable surface oxide when heated and exposed to air. This same cleaning action causes problems with steels. Iron oxide in and on the steel surface can be a good emitter of electrons that may attract the arc. But these oxides are not uniformly distributed, resulting in very irregular arc movement and, in turn, irregular weld deposits. This problem was solved by adding small amounts of oxygen to the argon. The reaction produces a uniform film of iron oxide on the weld pool and provides a stable site for the arc. This discovery enabled uniform welds in ferrous alloys and expanded the use of GMAW to welding those materials. The amount of oxygen needed to stabilize arcs in steel varies with the alloy. Generally, 2% is sufficient



for carbon and low alloy steels. In the case of stainless steels, about 0.5% should prevent a refractory scale of chromium oxide. Carbon dioxide can be substituted for oxygen. More than 2% is needed, however, and 8% appears to be optimum for low alloy steels. In many applications, carbon dioxide is the preferred addition because the weld bead has a better contour and the arc appears to be more stable.

#### 4.1.5 Defects caused by poor shielding

##### 4.1.5.1 Porosity

When gas is trapped along the surface or inside the weld metal, porosity occurs. As other weld flaws, a poor weld is a result of the porosity. It must be ground out and reworked (BernardWelds, n.d.).

Insufficient or contaminated shielding gas is the main reason for porosity. Using a nozzle that is too small for the application, or a nozzle full of weld spatter can also cause this weld flaw. Contamination of the base metal and/or overextension of the welding wire beyond the nozzle are additional causes for weld porosity. On warm days, air flow from cooling fans can disrupt the shielding gas blanket around the weld pool creating the same problem. Another common cause is a faulty seal or a loose fitting in the shielding gas channel through the welding gun. Any gas leaks can suck air into the gas flow causing faulty shielding and porosity possibility.



Figure 4.7: Porosity defect after welding.

#### 4.1.5.2 Incomplete Joint Penetration (Lack of Penetration)

Incomplete joint penetration appears when there is shallow fusion between the weld metal and the base metal instead of full penetration of the joint. It can often lead to weld cracking and joint failure.

Insufficient heat input and inadequate joint preparation are the main causes of incomplete joint penetration. The properties of the shielding gas mixture and wire diameter are also key factors, Figure 4.8.

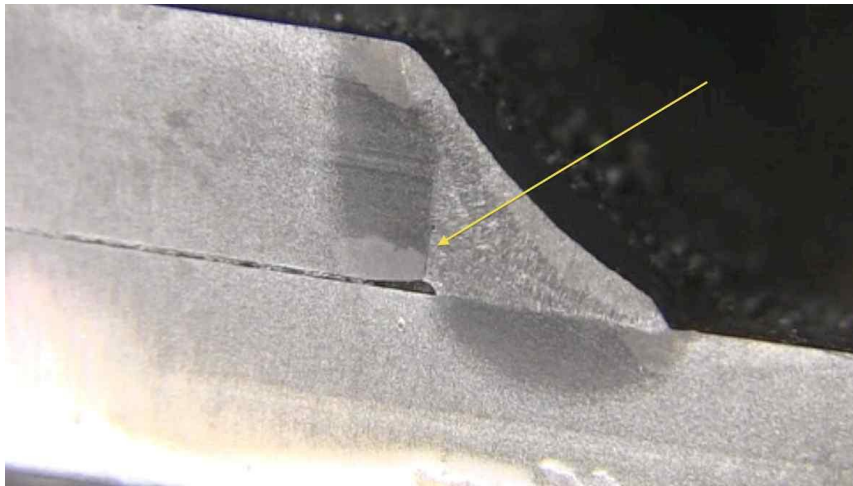

Figure 4.8: Incomplete joint penetration.

## 4.2 Applications of helium for welding different materials

### 4.2.1 Unalloyed carbon steels

Argon and carbon dioxide mixtures are commonly used shielding gases with unalloyed carbon steels. When using only helium or argon-helium mixtures penetration is minimal and the arc is unstable due to the high ionization energy. To stabilise the arc an oxidising component must be added to the mixture, and improved penetration requires a special component. These components are oxygen and carbon dioxide. Increased welding speed is a decisive factor for using helium mixtures. When using automated high performance GMAW-welding processes as T.I.M.E and Rapid Arc (Rand, et al., 2009) and using 3- or 4-component gases including argon, helium, carbon dioxide and/or oxygen, the best features from all gases can be achieved and the productivity can be increased. The helium content in the mixtures is 25...30 %, the stabilizing and oxidising subject is carbon dioxide and/or oxygen and their content is 5...8 % CO<sub>2</sub> and 0,5...1 % O<sub>2</sub>.

Applications using high performance automated GMAW-welding systems include beam production (cranes, vehicles, and steel buildings) and heavy steel production (e.g. framework for turbine housings).

#### 4.2.1.1 Case study of NGW MAG of Q235, with helium

The effects of the shielding gas (Ar-CO<sub>2</sub>-He) composition in narrow gap GMA welding were studied (Cai, et al., 2017). Applying the same current, the arc voltage increases by increasing the helium content. When wire feed speed and voltage remain constant, increasing the helium content causes the welding current to decrease. The arc length decreases significantly with the increase of CO<sub>2</sub> content and the arc core expands with the increase of helium content. When the shielding gas composition changes, arc properties and wire melting characteristics both changes and the arc works at a new equilibrium point to maintain the wire melting rate constant with the wire feed speed. Shielding gas with the addition of helium produces a bowl weld bead profile. The depth of sidewall fusion increases as helium content increases. The welding process and weld quality are good when the shielding gas is 80% Ar + 10% CO<sub>2</sub> + 10% He.

Steel Q235 was welded using H08Mn2Si as filler metal. The diameter of the wire was 1.2 mm. The power source was CLOOS 503 operated in DCEP mode. The U-groove with the bottom width of 10 mm, top width of 12 mm and depth of 25 mm was applied. Welding parameters and experimental design are presented in Table 4.3 and Table 4.4 correspondingly.

Table 4.3: Welding parameters (Cai, et al., 2017).

Wire feed speed, m/min	Original wire extension, mm	Welding voltage, V	Welding speed, mm/min	Gap, mm
9	18	26	580	2

Table 4.4: Experimental design (Cai, et al., 2017).

Weld	Ar %	CO <sub>2</sub> %	He %
1	90	5	5
2	85	10	5
3	80	15	5
4	75	20	5
5	70	25	5
6	90	10	0
7	85	10	5

8	80	10	10
9	75	10	15
10	70	10	20
11	65	10	25

Increasing the helium content also decreases the arc length, but it is not obvious. When the helium content exceeds 20%, the arc length is short. Helium has a higher thermal conductivity than argon. By increasing the helium content in the shielding gas, the thermal conductivity is increased, increasing the cross-sectional area through which heat can flow, thereby leading to a broader arc core. This type of arc produces a wider penetration profile, which improves fusion characteristics especially when welding inside the groove, and it is beneficial in narrow gap welding to ensure sidewall fusion, Figure 4.9.

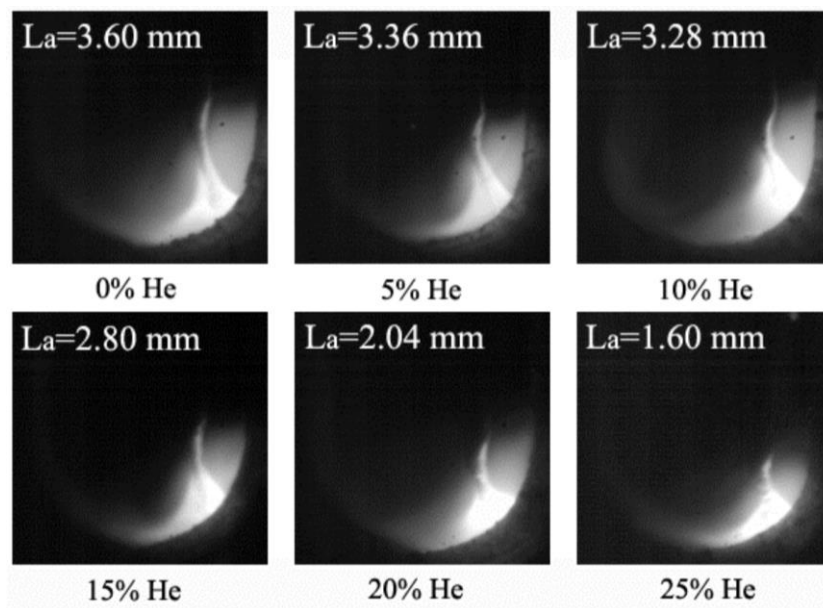

Figure 4.9: Arc shape with varied helium content. La is arc length (Cai, et al., 2017).

Helium has a low density and it disperses from the centre to the periphery of the arc. More heat is transferred to the periphery when the shielding gas has a higher helium content, so the potential gradient of the arc increases to compensate the energy loss. On the other hand, the helium has a higher ionization energy, so potential gradient increases with the increase of helium content. Therefore, when the current and arc length remain constant, the arc voltage increases when the helium content increases.

The amount of helium also has a substantial effect on wire melting characteristics, Table 4.5 and Figure 4.10. Compared with 0 helium content, the current increases when the helium content is 5%. Helium has a higher thermal conductivity than argon, so the

addition of helium causes more heat transfer to the periphery of the arc, and the arc temperature increases. More particles are ionized and the number of charged particles increase due to the thermal ionization, and because the welding voltage is constant, the welding current is higher. However, if the helium content increases further (>5%), the welding current decreases.

Table 4.5: Arc voltage and current in different helium content (Cai, et al., 2017).

He content, %	0	5	10	15	20	25
Voltage, V	26.5	26.99	26.91	26.96	27.16	26.97
Current, A	308.7	323.3	317.1	308.5	304.4	302.6

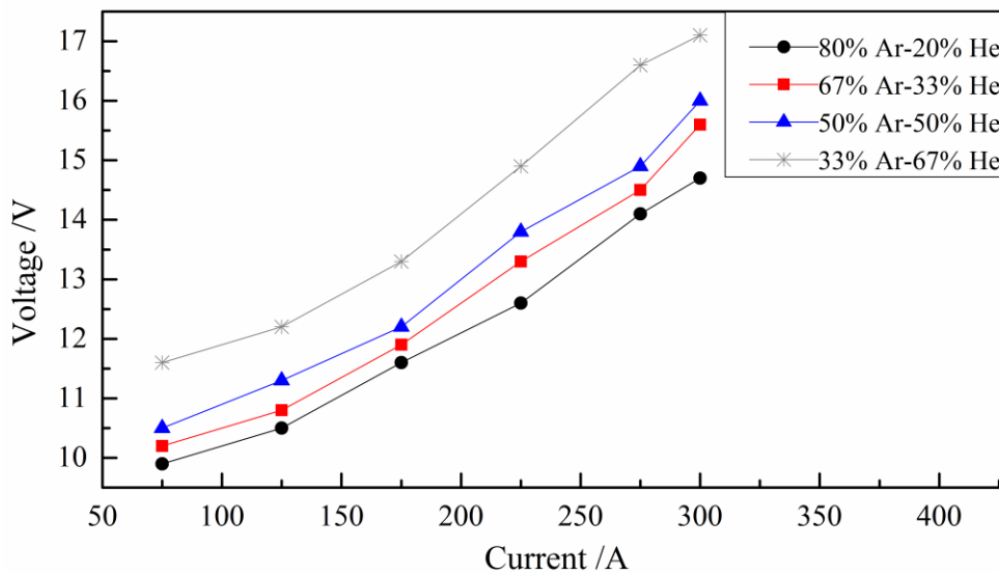

Figure 4.10: Arc voltage-current characteristics in different helium content (Cai, et al., 2020)

Experiment showed that at a constant wire feed speed, the wire constant melting curve "moves left" as the helium content increases, Figure 4.11.

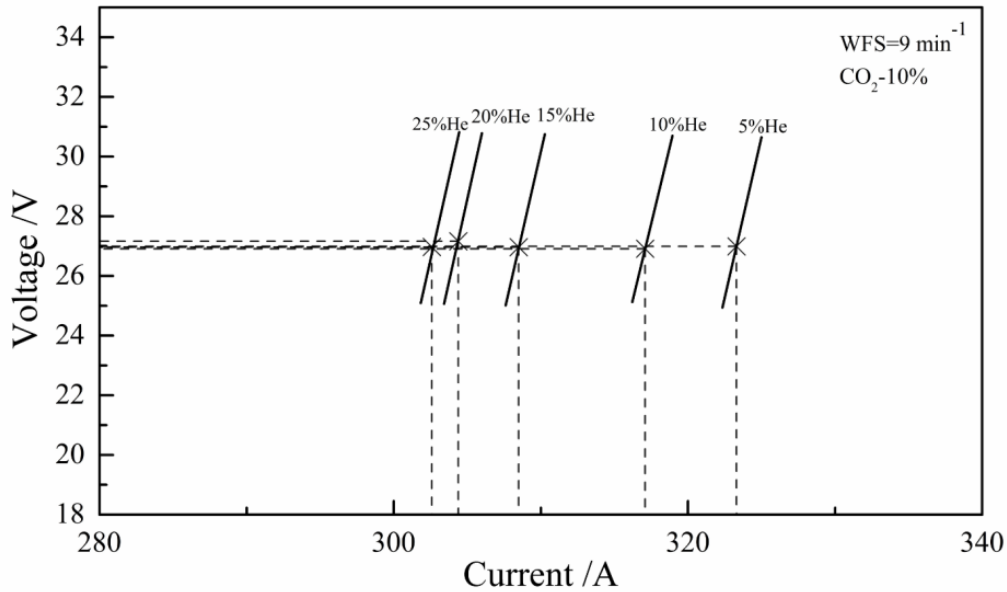

Figure 4.11: Wire constant melting characteristics in different helium content (Cai, et al., 2020).

The weld profiles in different helium content are presented in Fig. 4.12. As helium content increases, the finger-shaped profile transforms to bowl-shaped. The depth is at its peak when the helium content is 25%, but an undercutting defect occurs.

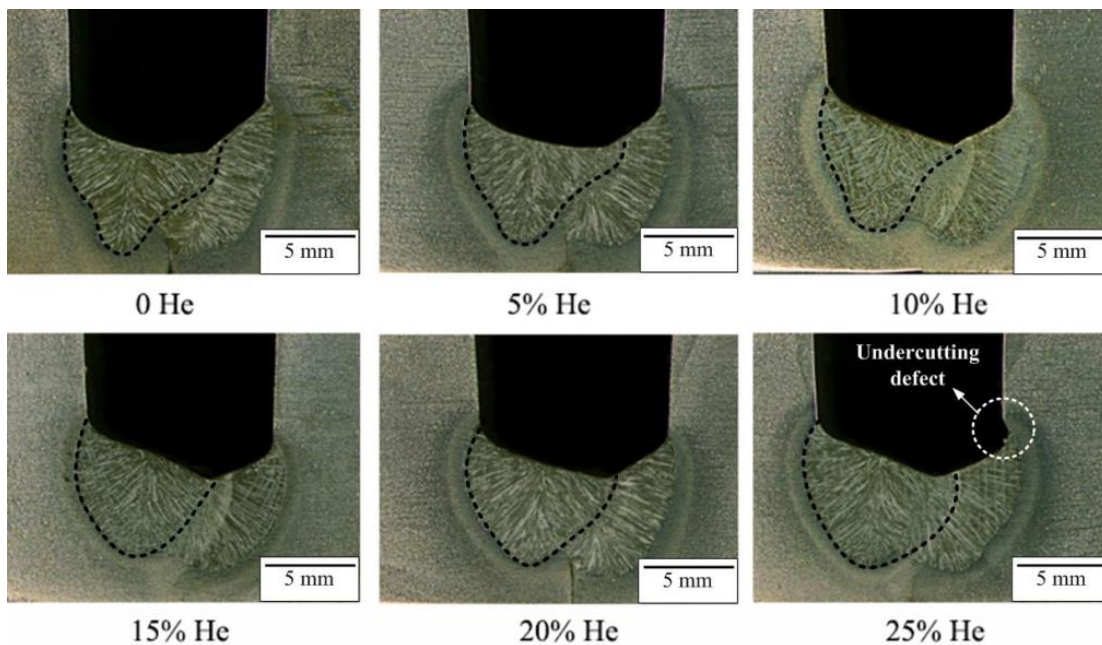

Figure 4.12: Weld profile in different helium content (Cai, et al., 2017).

The outcome of the study was that the arc core expands with the increase of helium content. The arc voltage-current properties change with shielding gas composition, and the welding voltage increases with the increase of the helium content in constant current and arc length. The other notable conclusion was that the shielding gas affects the constant wire melting characteristics. At a constant welding voltage, welding current decreases as helium content increases. When the shielding gas composition changes, the arc works at a new equilibrium position to keep the wire melting rate equal to the wire feed speed.

#### 4.2.2 Highly alloyed austenitic and non-austenitic steels

With these steels, helium can be used as shielding gas mixed with argon and hydrogen to achieve optimal effects from the shielding gas. The welding economy and efficiency is much better when using gas mixture compared to solely helium use.

Typical applications utilising helium mixed shielding gases in austenite steel TIG and GMAW welding are e.g. flexible hose products, the connection products (flanges etc.) and pipe parts production (T-pieces). With non-austenite steels helium mixtures (Ar + 30 % He and Ar + 30 % He + 1 % O<sub>2</sub>) are used e.g. in heat exchanger and mine machinery production with GMAW-welding. It seems so that many producers have changed where only possible the material from austenite to ferrite-austenite (so called Duplex) steels where argon-helium mixtures give production advantages: good visual quality, good mechanical properties and easier and more stable welding process (Lu, et al., 2009).

#### 4.2.3 Aluminium and its alloys

Helium is a good shielding gas for aluminium and its alloys mainly due to its good thermal conductivity properties. Helium is normally mixed with argon to achieve good penetration and technical efficiency and lower cost from the shielding gas.

In aluminium, copper and copper alloys welding pure argon or argon-helium mixtures are used. Helium increases the heat input which compensates for the substantial heat conduction in thick-walled aluminium or copper. The effect of increasing helium content in the argon shielding gas is explained in Table 4.6.

Table 4.6: Influence of increasing helium content in the argon shielding gas (Timings, 2008).

Shielding gas composition	100% Ar -----> 100% He
Arc behaviour	MIG: less stable; TIG: more diffuse
Cost of shielding gas	Increases
Fusion penetration	Deeper and rounder

Preheating	Can be lowered or left out completely
Seam width	Increases, seam shape flattens
Sensitivity to pores	Decreases
Temperature	Part gets warmer -> compensation by higher welding speed
Tendency of lack of fusion	Decreases
Welding speed	Can be increased

The shielding gas for aluminium and aluminium alloys is usually argon or argon with the helium addition. Helium improves heat transfer and is used when welding thicker sections. The welding current is normally AC or, at low current levels, may be DC with the electrode connected to the positive.

Under certain conditions, aluminium can be welded with DC if pure helium is the shielding gas and the electrode is connected to the negative. The higher arc voltage that results from the use of helium supplies more heat to the base material and thus increases the rate of welding. The high heat input also means that butt joints can be made in thicker sections. The open-circuit voltage of the power source should be sufficiently high to prevent the arc from being extinguished as a result of the higher voltage drop in pure helium.

A drawback of helium is that it is more difficult to ignite the arc, particularly with low welding currents. Argon is therefore generally recommended for manual welding, and helium for mechanised welding (Weman, 2012).

Aluminium welding applications with an argon-helium mixture are used with TIG and GMAW processes in boat building, fence production and vehicle industry products, e.g. Norway has for a long time been a major aluminium producer in the world due to its self-sufficiency in low cost renewable hydroelectricity.

When helium is added to the argon shielding gas mixture, it must be considered that due to the lower density of helium a higher gas flow volume is required to achieve the same shielding effect as with argon.

#### **4.2.3.1 Argon-helium mixtures (Miller, n.d.)**

To improve upon argon performance, helium is often added to the mixture to increase the heat transferred to the base material. Helium helps to increase arc energy and is ideal when welding aluminium and its alloys which are greater than 6 mm in thickness. The important benefits derived from increased heat transfer are reduced porosity (slower weld puddle solidification), fewer fusion defects, and potential increases in welding speed due to the more fluid weld pool. In GMAW a change from argon to an argon/helium mixture



will require an increase in arc voltage and the shielding gas flow rate to maintain a stable, spatter free spray arc welding condition. In constant current TIG welding, an increase in helium content will result in the welding machine adjusting to a higher arc voltage.

The amount of helium added to the shielding gas blend is generally limited by the adverse effect helium can have on arc ignition, arc stability and fine droplet metal transfer. In the MGAW process, because the helium content of the shielding gas increases, metal transfer becomes more irregular, resulting in higher levels of spatter. While the weld pool becomes hotter and the fluid increases with the addition of helium, the penetration width, but not the not depth, generally increases. This means the penetration profile may not be the most desirable for certain applications. Due to greater ionization energy required, helium generally reduces the stability of the arc in TIG welding and causes arc ignition characteristics to decline, leading to special problems when using AC power. Considering the cost and the benefits, the most common commercial blends for welding aluminium are argon with 25-30% helium. These results are indicated in Figure 4.13 and Figure 4.14.

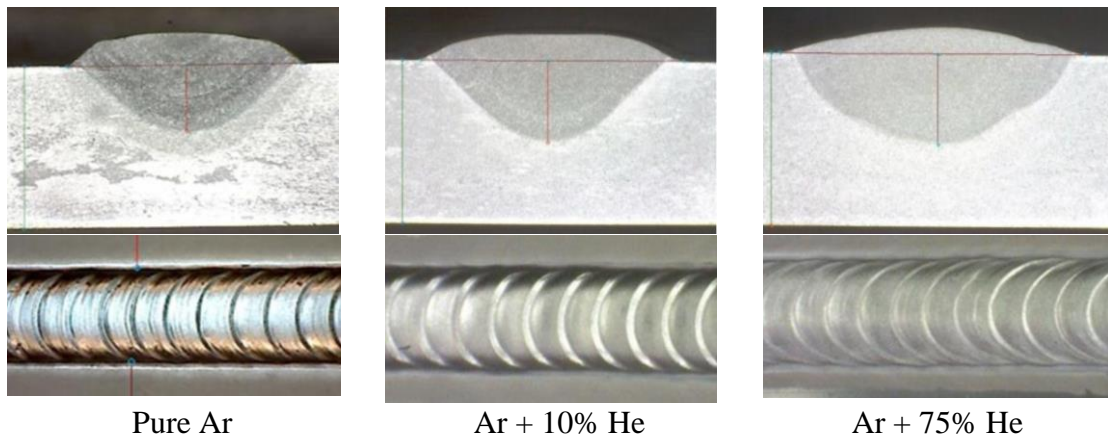

Figure 4.13: TIG (AC) welding of 6 mm thick aluminium with 4043 filler (Miller, n.d.).

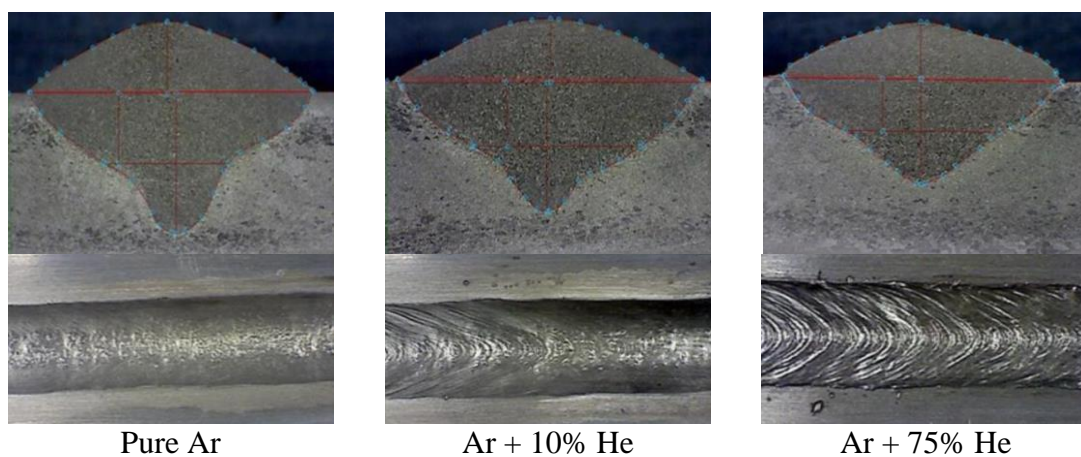

Figure 4.14: GMAW welding of 6 mm thick aluminium with 4043 filler (Miller, n.d.).

#### 4.2.3.2 Alternate argon and helium supply

In this study, Argon and Helium were alternately supplied as a shielding gas in welding 5A06 aluminium alloy GMAW. The effects of shielding gas flow rate and flow time on welding process are investigated in terms of (1) arc properties; (2) metal transfer behaviours; (3) weld bead profile.

A system for alternating shielding gas supply as shown in Figure 4.15 was used to supply Ar and He consecutively. The system consists of an electromagnetic directional control valve that feeds gas into the welding torch. When the valve is on the left side, the shielding gas is helium, and when the valve is on the right side, the shielding gas is Ar. The metal transfer process was recorded by a highspeed camera at a rate of 2000 frames per second. Exposure time was 1.5  $\mu$ s. The welding current and voltage were measured by an electrical signals acquisition system (Cai, et al., 2020)

The welding voltage was 22.5 V, wire feed speed was 6.5 m/min and welding speed was 300 mm/min.

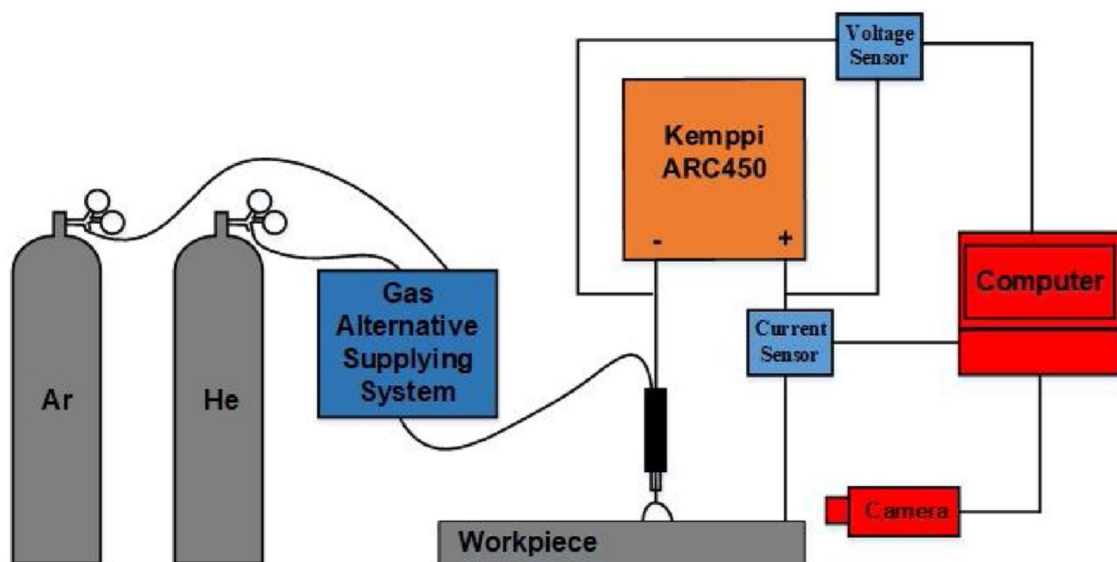

Figure 4.15: Schematic of the experimental setup (Cai, et al., 2020).

The alternating gas parameters were given in Table 4.7, two factors were taken into account: gas flow rate and flow time. The total gas flow rate was 24 L/min and the alternating frequency was 4 Hz. The switching time of the valve decides the gas flow time. The switching time contains the valve dwelling time on one side and the value of the movement time from one side to the other.

Table 4.7: Alternating gas parameters (Cai, et al., 2020).

Test	Ar flow rate, L/min	He flow rate, L/min	Ar flow time, s	He flow time, s

1	17	7	0.125	0.125
2	18	6	0.125	0.125
3	19	5	0.125	0.125
4	20	4	0.125	0.125
5	21	3	0.125	0.125
6	22	2	0.125	0.125
7	23	1	0.125	0.125
8	17	7	0.2	0.05
9	17	7	0.175	0.075
10	17	7	0.15	0.1
11	17	7	0.125	0.125
12	17	7	0.1	0.15
13	17	7	0.075	0.175
14	17	7	0.05	0.2

As presented in Figure 4.16, when the valve dwells on the left side, the helium is supplied, and when the valve moves from the left to the right, it is also considered that the helium is supplied, so the sum of the time of the two processes is the helium flow time.

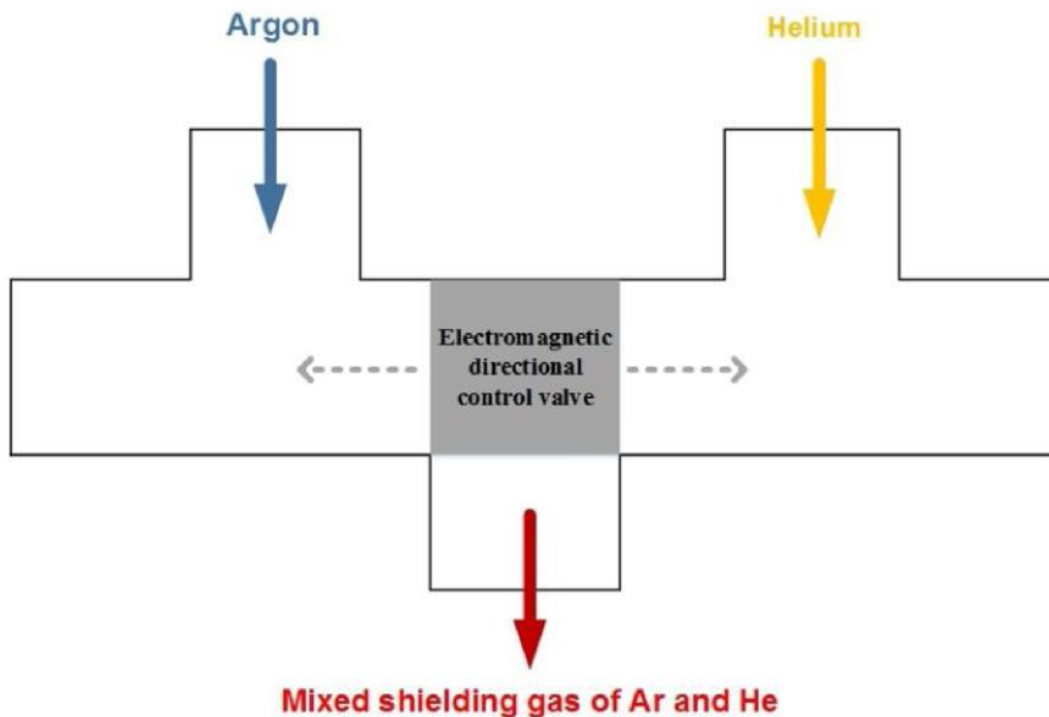

Figure 4.16: System for alternating supply of shielding gas (Cai, et al., 2020).

In the welding process, under the given welding parameters, the metal transfer modes changed with the alternating gas. When the Ar was supplied, the droplet transfer mode

was globular transfer; while the He was supplied, the droplet transfer mode was short-circuiting transfer, Figure 4.17.

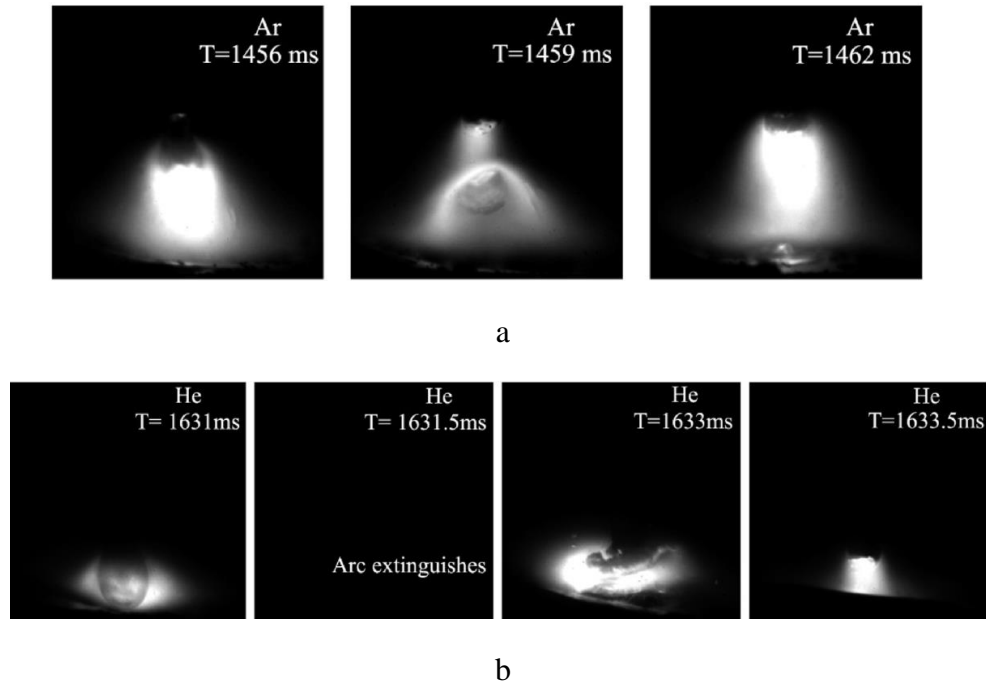

Figure 4.17: Droplet transfer process under different shielding gas. Test No. 1. (a) Globular transfer. (b) Short-circuiting transfer (Cai, et al., 2020).

Use of different shielding gases lead to different droplet transfer modes. Helium has a higher ionization energy, and the potential gradient is greater in the helium arc. In this study, the GMAW was operated under voltage command, in which the welding voltage was constant, so the arc length decreased as the helium content increased. Therefore, when the shielding gas is helium, the droplet size is larger and the arc length is short, resulting in short-circuiting transfer.

When helium was supplied into the arc space, the welding current increased, but decreased when argon was supplied. It was also discovered that short-circuiting transfer occurred when helium was supplied, Figure 4.18. When the helium flow rate or flow time increased, the short-circuiting transfer occurred more frequently.

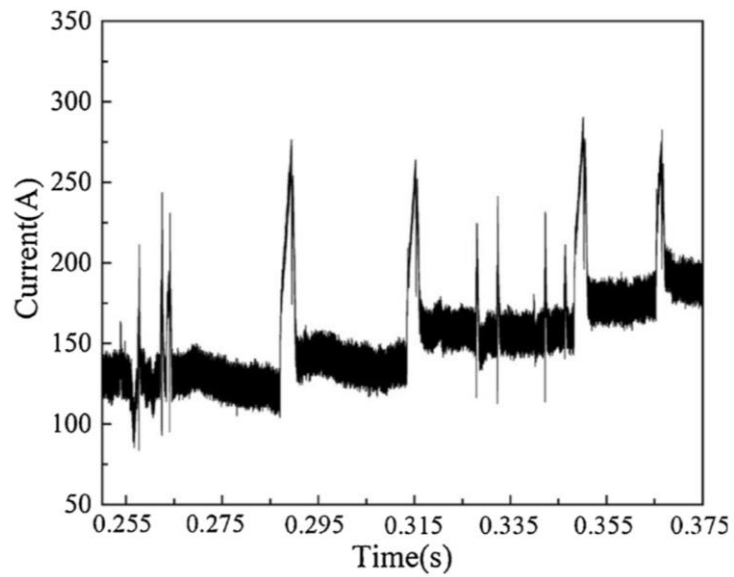

Figure 4.18: Welding current when helium was supplied. (No.1, 0.25s–0.375 s). (Cai, et al., 2020).

The penetration profiles are presented as Figure 4.19 and Figure 4.20, the penetration depths were measured and the values were plotted in Figure 4.21. It is evident that the penetration depth decreases first and then increases as the helium flow rate decreases, but finally decreases when the helium gas flow rate is 1 L/min.

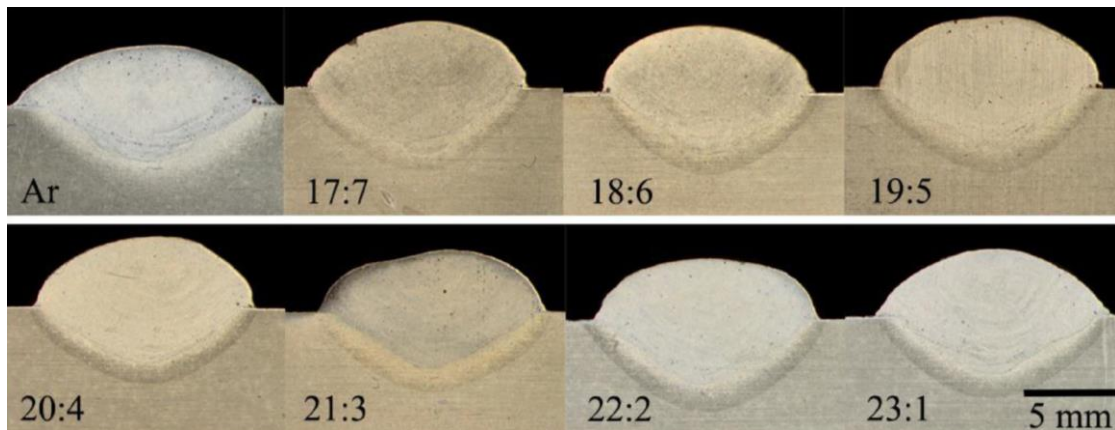

Figure 4.19: Penetration profiles under different gas flow rate ratios (Ar:He). (Cai, et al., 2020).

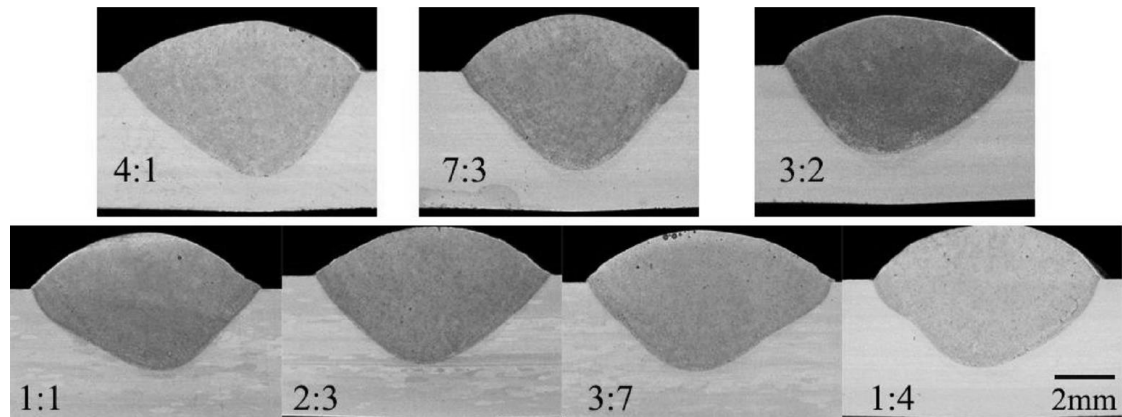

Figure 4.20: Penetration profiles under different gas flow time ratios (Ar:He). (Cai, et al., 2020).

As the helium flow time increases, the penetration depth decreases first and then increases, but when the helium continues to increase, the penetration depth is almost constant.

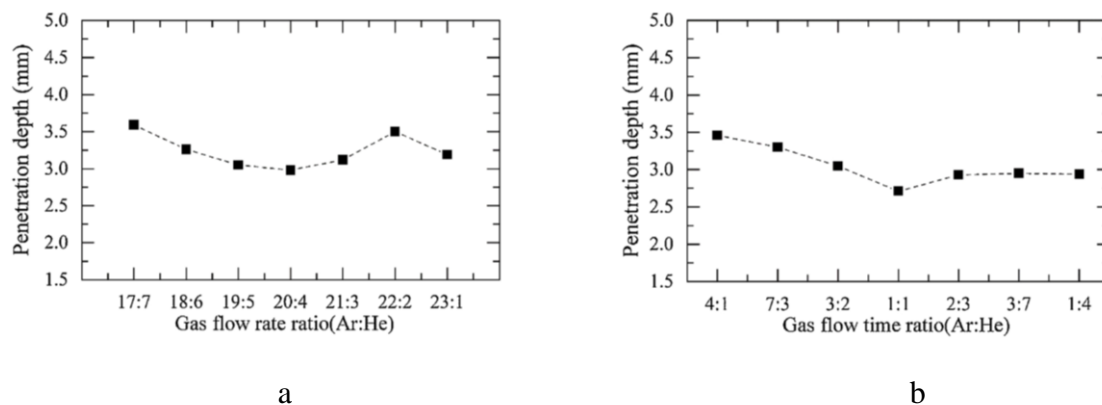

Figure 4.21: Penetration depths under different gas flow rate ratios (Ar:He). (Cai, et al., 2020).

As shown in Figure 4.22, the variations of arc pressure give rise to the variation in the behaviour of the weld pool. Alternately supplying Ar with a higher arc pressure and He with a lower pressure causes the weld pool to move downwards and vice versa. However, in GMAW, the arc pressure is not the key factor affecting the molten pool behaviour. During the GMAW process, the wire melts and the droplets transfer to the molten pool, and the droplet impact has a stronger effect on the fluid flow behaviour of the molten pool.

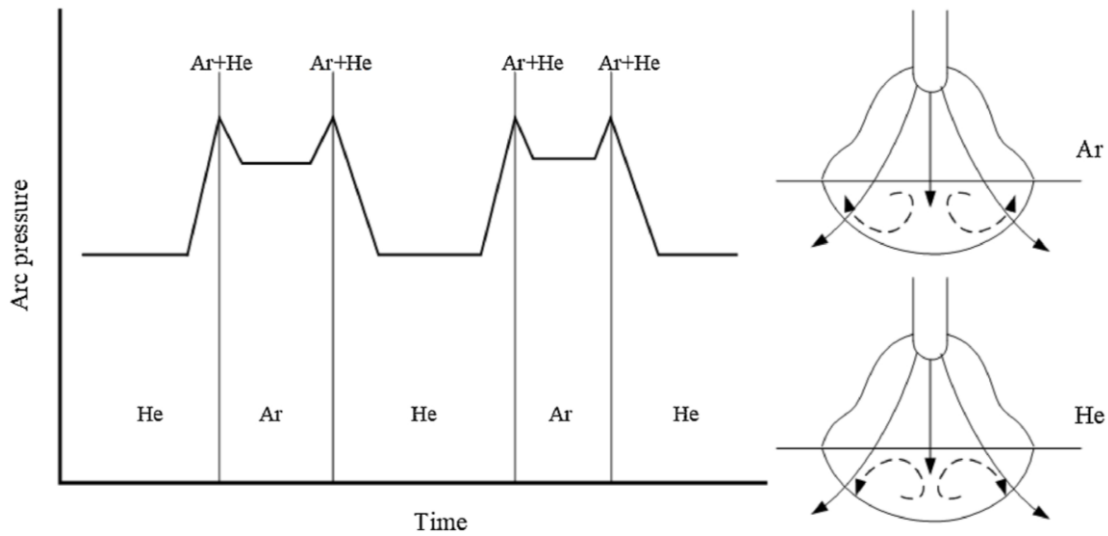

Figure 4.22: Schematic diagram showing the variation of arc pressure. (Cai, et al., 2020).

When the helium flow rate increases, the arc energy increases but the short-circuiting transfer occurrence frequency increases. The droplet impact acting on the molten pool is larger for globular transfer, so the globular transfer can provide a greater penetration depth. As the helium flow rate increases, the helium content in the shielding gas increases, and the arc generates a higher energy, which can increase the penetration depth. However, it was found that the penetration depth does not change monotonously. When the helium flow rate is relatively low (0–2 L/min), the short-circuiting transfer counts are few, and then the arc energy mainly affects the penetration, so the depth increases as the helium flow rate increases. When the helium flow rate increases continually, the count of the short-circuiting transfers increase, and with the impact of the droplet being the key factor, the depth decreases. When the helium flow rate is relatively high (4–7 L/min), the short-circuiting transfer counts do not change clearly, so the heat energy becomes the main factor again, and the penetration depth increases as the helium flow rate increases.

Similarly, as the helium flow time increases, the short-circuiting transfer counts increase significantly, and the depth decreases. When the helium flow time is long enough, the arc energy is the main factor determining the penetration, so the depth increases, but it is not evident.

The study concludes that the arc characteristics change with the alternating Ar-He shielding gas. The current fluctuates as the gas supply alternates. When the helium flows into the shielding gas, the welding current increases, and when argon is provided, the welding current decreases. The difference between the peak current and valley current decreases, as the helium flow rate increases. Additionally, the metal transfer mode fluctuates with the alternating Ar-He supply. When helium is supplied, the metal transfer mode is short circuiting transfer, and when argon is supplied, the mode is globular transfer. With the increase of the helium flow rate or flow time, the short-circuiting



transfer counts increase. And finally, the penetration depth is affected by the metal transfer mode and arc heat transfer. When the helium flow rate increases, the penetration depth increases first and then decreases, and finally increases again. When the helium flow time increases, the penetration depth first decreases, then increases slightly.

#### **4.2.4 Copper and its alloys**

Copper is a material with good thermal conductivity and therefore helium is a good choice for shielding gas. To achieve beneficial penetration and cost efficiency from the shielding gas, helium is normally mixed with argon. One of the interesting applications with helium shielding gas has been the TIG welding of 600 mm wide copper webs in transformer windings. Argon is also suitable for welding copper in all positions, and gives excellent results when welding metal thicknesses up to about 6 mm. The main reason for this is the good penetration profile of argon when welding thin materials. The high thermal conductivity of copper generally requires preheating. When welding plates with thickness more than 6 mm pure helium or helium-argon (containing about 35 % argon) is a good shielding option. (Weman, 2012).

#### **4.2.5 Titanium**

Helium is a good shielding gas in titanium welding, but normally helium is mixed with argon. Also, pure argon works well as a shielding gas when working with titanium. Successful titanium welding requires a high purity shielding gas, not less than 99.99 %. In addition, extra shielding gas is generally required. Either helium or argon can be used, although argon is generally preferred for metal thicknesses up to about 3 mm due to its higher density, good shielding performance and the penetration profile. The use of pure helium is recommended when welding thick sections, due to the good thermal conductivity, higher heat input into the arc and better penetration profile compared to argon (Weman, 2012).

### **4.3 The production of helium shielding gas mixtures**

Helium shielding gas mixtures normally contain two or three components. The basic shielding gas delivery unit is a high-pressure gas cylinder with a working pressure of 200 bar or 300 bar, Figure 4.23 a, b.



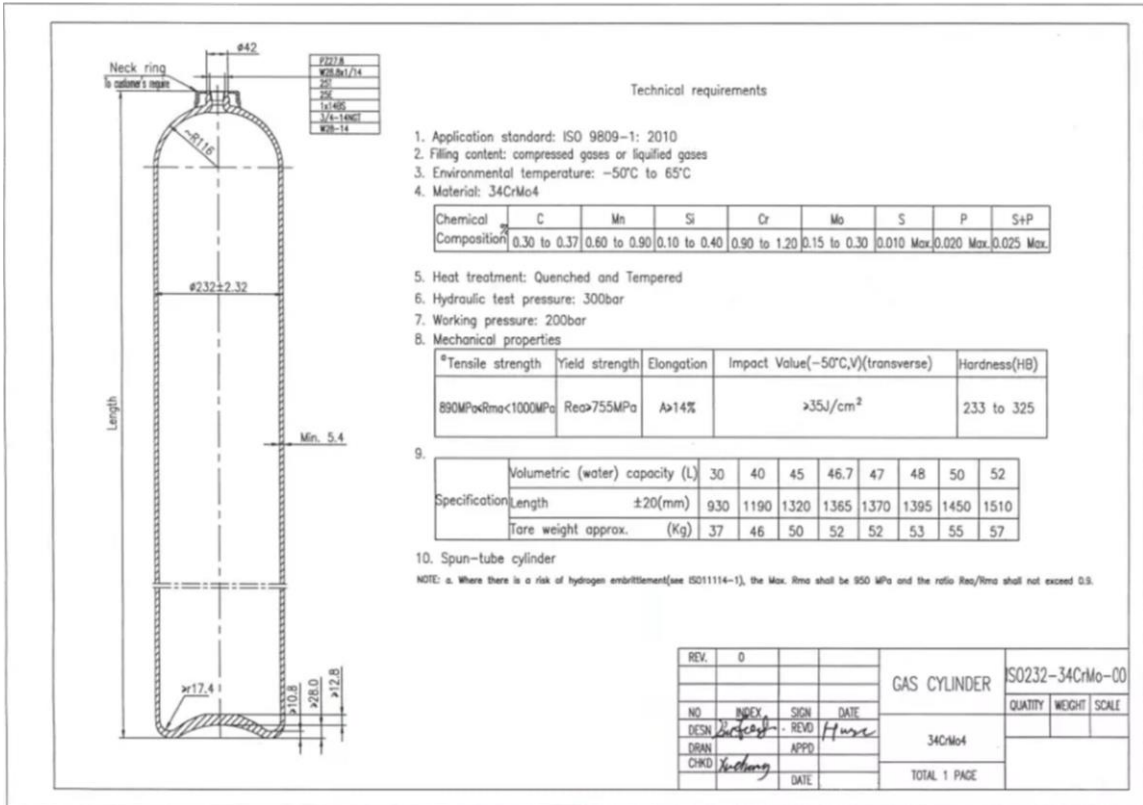

a



b

Figure 4.23: 50 l/200 and 300 bar cylinders. (a) Gas cylinder drawing. (b) Photo of gas cylinders (Woikoski, Finland, Worthington Cylinders, Austria).

The cylinders are filled with the required mixture using a pressure filling system. The lowest content component is filled first and the second lowest component next and the balance gas tops up the mixture to the requested working pressure. The filling accuracy in mixtures including the percentage level of components under 10 % is  $\pm 0.5$  % abs. and above 10 %  $\pm 1$  % abs. Mixtures can be prepared to a higher accuracy if required, but this is normally unnecessary in gas arc welding applications. Using single high-pressure cylinders of 50 l/200 bar, the customer can commonly manage with up to 150 cylinders annually.

In case required amounts are greater, it is recommended to use cylinder bundles which is made of 12 pieces 50 l/200 bar or 300 bar cylinders (120-180 Nm<sup>3</sup>/unit) connected by flexible hoses at the valves. Filling and discharging the cylinders can be done from one inlet/outlet connection, Figure 4.24. This delivery method is for an annual gas use of up to 1500-5000 Nm<sup>3</sup>.



Figure 4.24: Argon-carbon dioxide bundle (12x50 L/200 bar) (Woikoski, Finland).

In case the annual use is greater, the required gas mixture can be produced on site with a special mixing unit that can handle two or three components easily and accurately. Figure 4.27.

With this kind of system argon is delivered in liquid form by a lorry equipped with a vacuum insulated tank. On site is a vacuum insulated storage tank where liquid argon (LAR) is pumped and stored. The tank is a double shell tank equipped with a high vacuum between the tanks, the pressure between the shells being approximately 100 micro bars. The evaporation range in the tank is approximately 0.4-0.5% per day indicating about a month-long operating time without gas losses. The operating tank pressure is in the range of 7-9 bar and the safety valve level in this kind of tank is at 15-20 bar, Figure 4.25.

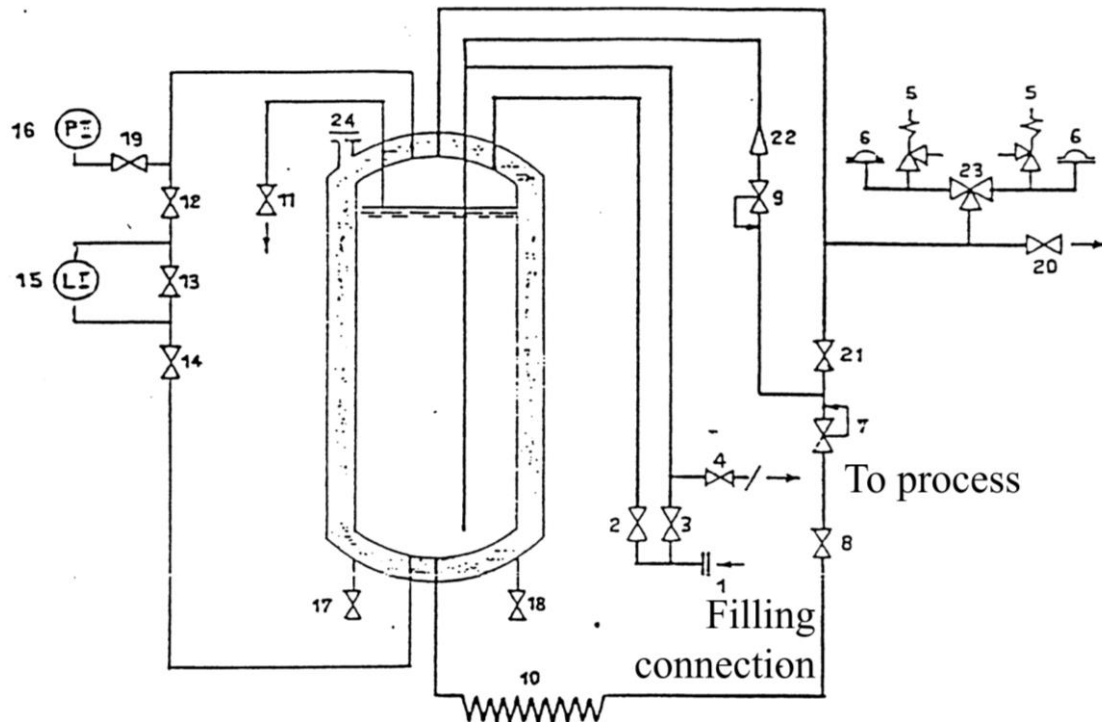

Figure 4.25: Flow diagram of a vacuum insulated tank, where 1 - filling flange; 2 - upper fill valve; 3 - under fill valve; 4 - evaporator shut-off valve; 5 - safety valves; 6 - rupture discs; 7 - pressure regulator; 8 - down evaporator shut-off valve; 9 - bypass valve (gas regulator); 10 - lower evaporator; 11 - overflow valve; 12, 13, 14 - flow meter shut-off valves; 15 - flow meter; 16 - pressure gauge; 17, 18 - vacuum valves (measuring and suction); 19 - pressure gauge shut-off valves; 20 - pressure relief valve (gas); 21 - gas shut-off valve; 22 - non-return valve; and 23 - three-way valve.



Figure 4.26: Vacuum insulated liquid argon tank with an ambient vaporizer (Chart Ferox, Czech Republic).

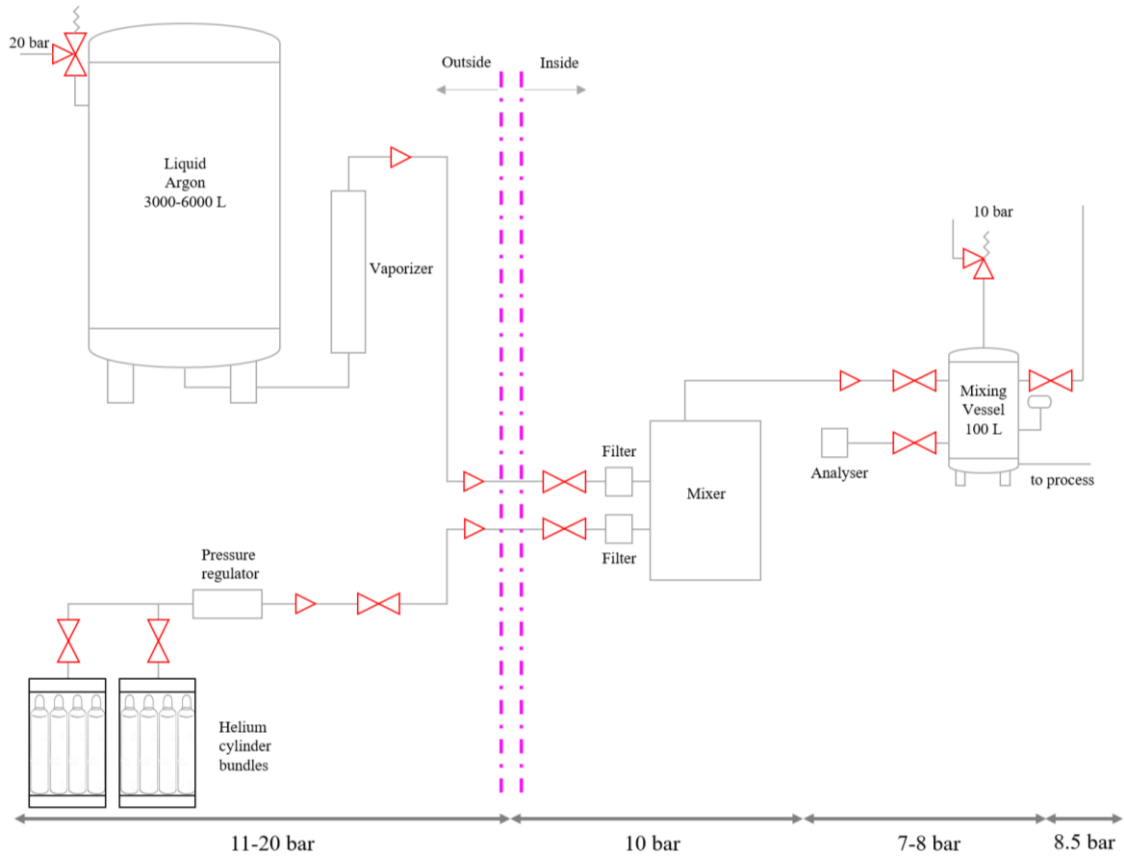

Figure 4.27: Argon-helium shielding gas on-site mixing system (Woikoski, Finland).

The component gases are delivered from bundles or cylinder containers or in liquid form and evaporated to gaseous form and mixed with a special mixing unit, Figure 4.28.



Figure 4.28: Two or three component gas mixing unit (Witt, Germany).

Normally gas delivered in liquid form is argon. Helium is delivered in gaseous form in cylinders or in bundles. Hydrogen is also delivered in gaseous form and carbon dioxide is delivered in bundles or in liquid form with tank delivery. The gas mixture can be analysed on site, Figure 4.29. The analysis can also be connected to the quality system tracing the shielding gas on the manufacturing process.



Figure 4.29: On-line analyser for the shielding gas mixture component (Witt, Germany).

#### 4.4 Optimization of the shielding gas delivery method

The direct shielding gas costs are the gas price, cylinder rental and logistics cost of the cylinder delivery, including the workshop gas pipeline system. These elements are sufficient to compile the fixed and variable cost diagram, Figure 4.30. Fixed costs include the rentals and variable costs comprise the sum of the gas price and logistics cost. The comparison can be made between the different delivery methods. The diagram shows the point when it is more economical to transport the gas in liquid form. In shielding gases argon and carbon dioxide can be delivered in liquid form. These gases are stored in vacuum insulated storage tanks. The boiling temperature of liquid argon is  $-186^{\circ}\text{C}$  at an atmospheric pressure. The vacuum insulated storage tank is at a pressure level of 100 micro bar, meaning small volumes of gas evaporate every day. If the production withdraw from the tank is less than the evaporated volume the pressure increases inside the tank. The safety valve level is at the range of 18bar and the working pressure at 10bar, therefore with every tank size the technical operational limit of the liquid tank use marked on the diagram, can be calculated. This limit must be considered when deciding on the delivery method. The same effect does not appear with carbon dioxide delivery because its boiling point is  $-78,5^{\circ}\text{C}$  which means a low daily evaporation rate. The physical properties of carbon dioxide are different compared to other shielding gases. It is in liquid form in the normal one shell high pressure gas cylinder at a pressure of 40 bar.

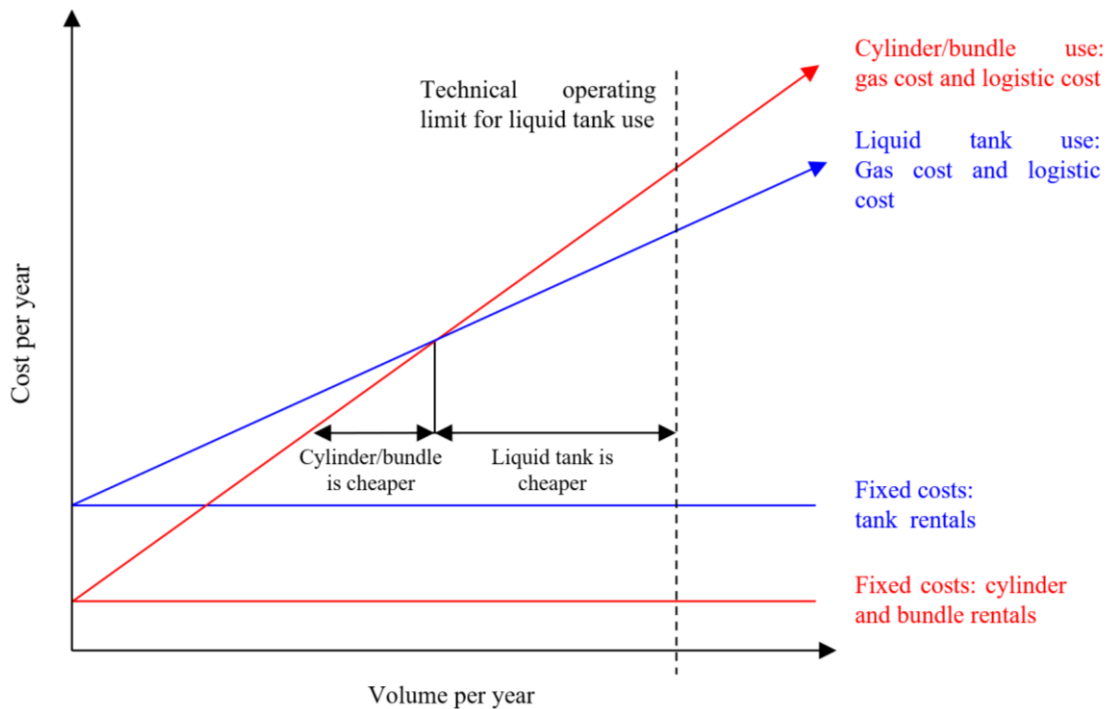

Figure 4.30: Optimization of the gas supply system.

## 4.5 Helium and helium mixtures in different welding processes

### 4.5.1 Helium and helium mixtures in GMAW welding

The most advanced high-performance welding processes such as T.I.M.E. and Rapid arc use helium mixtures. These mixtures contain 3 or 4-component gases including small amounts of oxygen and carbon dioxide and 25 – 30 % helium, and the balance gas is argon. The mixture guarantees the best shielding gas properties, delivering good arc ignition, excellent penetration, and thermal conductivity, leading to improved welding speed and greater deposition rate. Normally this type of high-performance process is applied in automated fillet welding. This kind of process can also be utilized in hand welding, reaching the same advantages as in automated robot welding, but on a smaller scale. Mainly GMAW-welding is used with non-alloyed and low-alloyed carbon steels, but also stainless steel and other materials can be welded. Welding aluminium with using the GMAW-process has developed significantly due to the development and better automation control of new generation welding machines.

Table 4.8: Effect of welding gas composition on the GMAW process and result (Sarma, 2014).

Criteria \ Gas	Ar + CO <sub>2</sub> (max25% CO <sub>2</sub> )	Ar + CO <sub>2</sub> + He	Ar + O <sub>2</sub>	CO <sub>2</sub>
Penetration in flat position welding	OK	OK	Adequate; good with thin sheets	OK
Penetration in out-of-position welding	Safer with more O <sub>2</sub>	Safer with more CO <sub>2</sub>	Can be critical due to very liquid weld pool	Very safe
Avoidance of lack-of-fusion	OK	Improved by helium content	Adequate	Adequate
Degree of oxidation	Decreases with decreasing CO <sub>2</sub> content	Decreases with decreasing CO <sub>2</sub> content	Higher than comparable gases containing CO <sub>2</sub>	High
Pore formation in the weld seam	Becomes lower with decreasing CO <sub>2</sub> content	Becomes lower with increasing CO <sub>2</sub> content	Most sensitive	Very low
Gap bridging	Becomes better with decreasing CO <sub>2</sub> content	Improved by helium content	Good	Poor
Spatter ejection	Decreases with decreasing CO <sub>2</sub> content	Decreases with decreasing CO <sub>2</sub> content	Low spatter	Heaviest
Notch effect at weld toe	Low	Lowest	Increases with sheet thickness	High
Heat transfer, heat input	Increases with increasing CO <sub>2</sub> content	Increases with rising CO <sub>2</sub> or helium content	Lowest	High
Arc types that are particularly recommended	Short arc, Spray arc, Pulsed arc	Short arc, Spray arc, Pulsed arc	Spray arc, Pulsed arc	Short arc



Argon, after leaving the torch nozzle, forms a blanket over the weld area. Helium, because it is lighter, tends to rise around the nozzle. Experimental work has consistently shown that to produce equivalent shielding effectiveness, the flow of helium must be two to three times that of argon. The same general relationship applies for mixtures of argon and helium, particularly those high in helium content.

Another influencing characteristic is arc stability. Both gases provide excellent stability when using direct current power. When using alternating current power, common in welding aluminium and magnesium, argon is superior to helium because argon provides much better arc stability and a highly desirable cleaning action.

Argon and helium are inert gases and can thus be used with all materials to be welded, but their specific physical properties must be considered.

Argon has a much lower ionization potential than helium (15.7 eV argon and 24.5 eV helium) and a much higher electric conductivity. Argon facilitates easier arc ignition and stability than helium, but the arc length at the same current is shorter and gives higher voltage with helium than with argon.

The thermal conductivity of helium is much greater than that of argon. Thus, with the same current, an arc under helium is more opened out than under argon, and leads to a lower heat gradient at the level of the parts to be assembled, promoting bead wetting (Blondeau, 2008).

It has been determined that the shielding gas parameters have a significant effect on the thermal properties of the solidified weld. A lower shielding gas flow rate and a shielding gas composition containing helium were found to reduce the linear thermal expansion coefficient, increase the specific heat capacity and the thermal conductivity, whilst the thermal diffusivity was independent of the shielding gas parameters. Thus, it can be concluded that for the same level of heat input to the workpiece, a lower shielding gas flow rate and a shielding gas composition containing helium will result in less weld-induced distortion as result of lower degree of weld metal contraction, and quicker dissipation of the heat to the surrounding plate, resulting in quicker thermal equilibrium with the surrounding material. In addition, the higher Cp associated with these configurations would result in a quicker weld metal cooling rate, producing a finer microstructure (Ley, et al., 2015).

#### **4.5.2 Helium and helium mixtures in TIG welding**

TIG welding with a helium or helium-argon mixtures shielded arc is mainly used with special welding applications with stainless steels, aluminium, copper, and special materials.

The advantages are:

- good control of the melted material and penetration

- possibility for welding thin material
- good quality and pure weld without spattering
- small space need

The disadvantages are:

- low welding speed with thicker materials
- stable welding circumstances required (no draft)
- clean materials required

With helium and helium mixtures the applications and characteristics of TIG welding can be improved considerably. These processes include narrow cap, hot wire, TOP TIG, and double gas processes.

Helium offers the advantage of deeper penetration. The arc force with helium is sufficient to displace the molten weld pool with noticeably short arcs. In some mechanized applications, the tip of the tungsten electrode is positioned below the workpiece surface to obtain very deep and narrow penetration. This technique is especially effective for welding aged aluminium alloys prone to over aging. It is also highly effective at high welding speeds, as for tube mills. However, helium is less forgiving in manual welding. With helium, penetration and bead profile are sensitive to the arc length, and the long arcs needed for feeding filler wires are more difficult to control. Helium has been mixed with argon to gain the combined benefits of cathode cleaning and deeper penetration, particularly for the manual welding. The most common mixture is 75% helium and 25% argon. Although the TIG process was developed with helium as the shielding gas, argon is now used whenever possible because it is cheaper. Helium is also having the disadvantage because it is lighter than air, thus challenging the good shielding. Its flow rates must be about twice as high as those of argon to make a good shielding and proper protection is difficult especially in draft conditions. Helium is difficult to ionize, necessitating higher voltages to support the arc and causing more difficulties in arc ignition, Figure 4.31. Alternating current arcs are unstable. However, helium is not used with alternating current because the cleaning action does not occur (Jeffus, 2012).

For mechanised welding, the shielding gas is typically argon, with a mixture of helium or hydrogen to increase heat input.

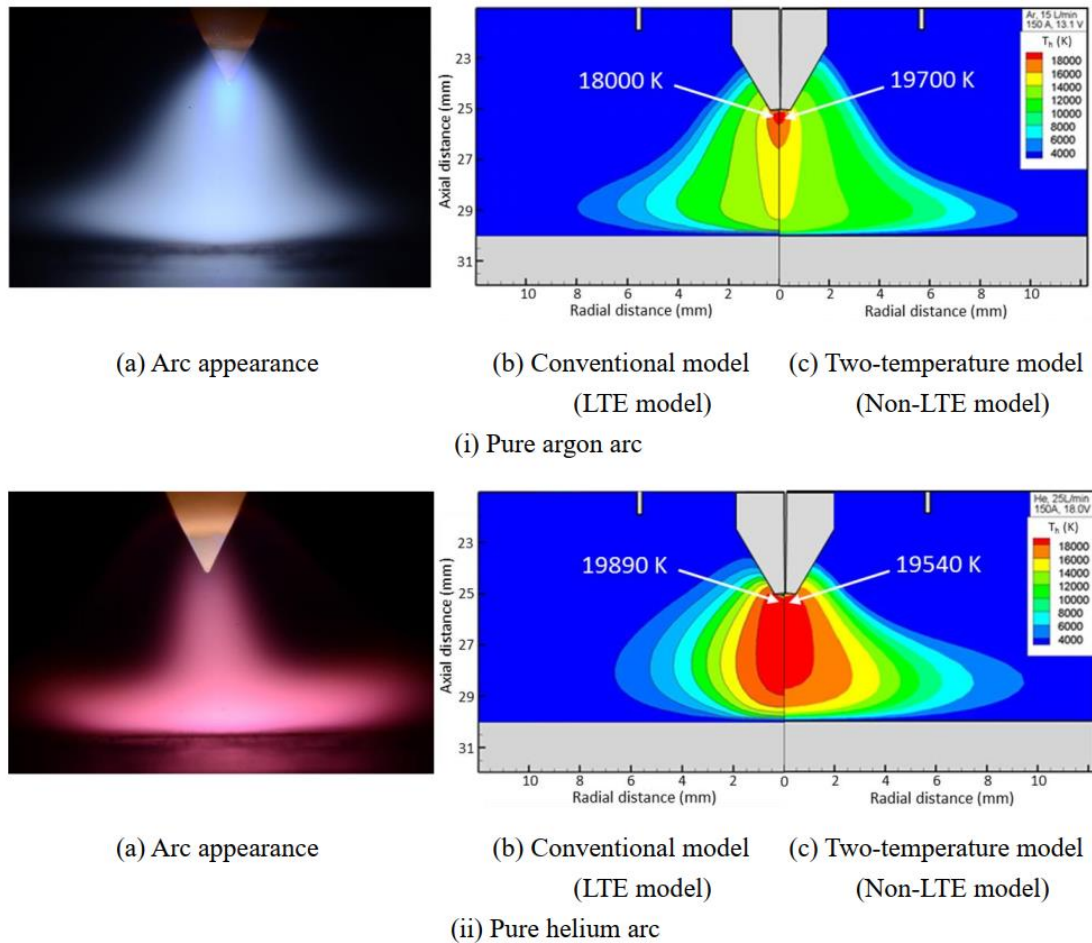

Figure 4.31: Arc appearance (argon and helium) and simulation results of temperature distribution (Konishi, et al., 2016).

### 4.5.3 Helium and helium mixtures in laser welding

In laser welding helium is the main shielding and plasma control gas due to its properties that prevent the formation of a plasma cloud. In laser welding with helium the penetration can be deep and narrow due to the thermal conductivity of helium. Helium also improves the welding speed, the weld is very narrow, and the quality is good.

The CO<sub>2</sub> laser generates its ray in a tube through which a mixture of gases (including CO<sub>2</sub>) flows, producing a wavelength of 10.6  $\mu\text{m}$ . The energy input is by means of an electric discharge through the gas. It can produce high power output and is therefore popular for welding and cutting applications. The ray is usually conveyed to the welding head and focused by mirrors. A shielding gas (often helium or an argon-helium mixture) is used to protect the lens and the weld. This helps to limit the amount of energy-absorbing plasma formed above the surface of the joint. Helium is preferred for this purpose, due to its high ionization energy (Weman, 2012).

The selection of the shielding gas is governed by the following parameters:

- The metal type and its associated chemistry
- The process parameters and types (conduction or keyhole)
- The laser wavelength
- Necessity to alter the weld chemistry with active shielding gas components

#### 4.5.4 Helium and helium mixtures in plasma welding

The advantages in plasma welding are:

- good penetration
- weld up to 10 mm with one weld
- one side weld
- no spattering

The disadvantages with plasma welding are

- expensive investment cost of devices
- small tolerances in caps
- exact adjustment of the welding parameters

Plasma welding requires two gases, plasma gas and a separate shielding gas. These gases can be the same, but to achieve best results and advantages from the welding, different gases or gas mixtures can be used.

Normally the plasma gas is argon or an argon-hydrogen mixture, because the gas must be inert or slightly reducible with a low ionization energy and high density with high heat capacity and good thermal conductivity. Argon and argon hydrogen mixtures also fulfil these properties. When mixing helium with argon or argon-hydrogen mixture, the arc temperature is high and the welding speed can be increased. This plasma gas mixture can be used in keyhole welding. In the same way the plasma shielding gas can contain helium, producing the same effects (thermal conductivity, higher welding speed, good penetration).

Mixtures of argon/helium/nitrogen are used when welding duplex stainless steels, as these contain nitrogen in their alloying. Pure helium is not suitable, as the resulting high heat losses in the plasma gas will substantially reduce the life of the plasma torch. Argon/helium mixtures result in a higher energy level in the plasma jet at a constant current. However, the mixture must contain at least 50% helium if any significant difference is to be noted. Mixtures containing more than 75% helium have the same characteristics as pure helium (Weman, 2012).

Contrary to TIG, the efficiency of the plasma welding process decreases by increasing the helium content in the argon shielding gas (Figure 4.32). Physically, the thermal conductivity of helium is higher by a factor of nine, compared to that of argon. Therefore, the heat transport from the welding arc core to outer sections is higher when using helium. In plasma welding, the arc is highly focused. Therefore, the radiation and conduction losses, and the convective heat of the welding arc are increased by the addition of helium. It results in greater thermal load of the plasma dip, and this prevents the resulting expansion of the welding arc.

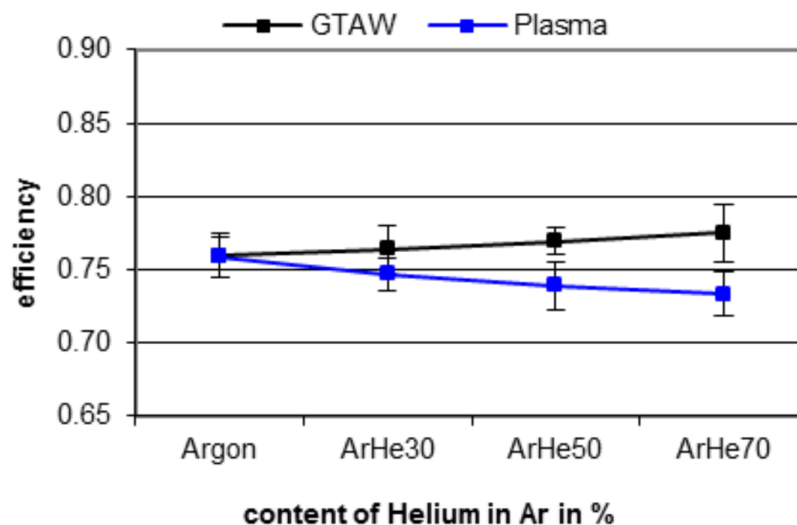

Figure 4.32: Influence of the helium content in argon shielding gas in GTAW (TIG) and Plasma welding (Haelsig, 2015).

#### 4.5.5 Helium and helium mixtures in hybrid welding

Hybrid welding means the combination of different processes, e.g., laser + GMAW or TIG + plasma. The main purpose in hybrid welding is to improve productivity, efficiency, and quality. Helium and helium mixtures offer their proportional advantages, adding value to the hybrid welding processes and increase the competitiveness in advanced automated and robot welding processes.

### 4.6 Effects of shielding gases to productivity and economy of welding

#### 4.6.1 Shielding gas effects to the productivity

The welding processes needing shielding gases are the gas arc welding processes (GMAW, TIG and plasma welding), laser welding, their combinations (hybrid welding) and MIG soldering. The basic function of the shielding gas is to protect the arc and the melted metal from the effects of the surrounding air (consisting mainly of oxygen,

nitrogen, and moisture) and by this means to offer the arc the most favourable conditions for good shield welding quality.

The function and effect of the different shielding gases in welding are gathered in Table 4.9.

Table 4.9: Function and effect of shielding gases in the welding process.

GAS	Chemical activity	Ionization energy	Atomic weight and density	Thermal conductivity	Arc behaviour	Production + availability	Economy	Shielding properties & effect to welding (1- poor 5- excellent)
Argon Ar	Inert <ul style="list-style-type: none"> <li>No reactive component with any subject</li> </ul>	Low ionization energy <ul style="list-style-type: none"> <li>Good ignition</li> </ul>	High density and big molecular weight <ul style="list-style-type: none"> <li>With small amount sufficient shielding</li> </ul>	Low thermal conductivity <ul style="list-style-type: none"> <li>Narrow penetration</li> </ul>	Unstable arc <ul style="list-style-type: none"> <li>Wandering arc to oxide spot to spot</li> </ul>	Air separation 0,94% in air, good availability	Relatively inexpensive	4
Helium He	Inert <ul style="list-style-type: none"> <li>No reactive component with any subject</li> </ul>	High ionization energy <ul style="list-style-type: none"> <li>High arc voltage</li> <li>High welding speed</li> <li>Poor ignition</li> </ul>	Low density and small molecular weight <ul style="list-style-type: none"> <li>Removes gases from plasma and decrease porosity</li> <li>Makes plasma more homogenous</li> <li>Relatively big flow needed for the shielding</li> </ul>	Good thermal conductivity <ul style="list-style-type: none"> <li>Good penetration</li> </ul>	Unstable arc <ul style="list-style-type: none"> <li>Wandering arc to oxide spot to spot</li> </ul>	Extracted from natural gas in LNG plants, Limited availability	Expensive	5
Carbon dioxide CO <sub>2</sub>	Oxidizing <ul style="list-style-type: none"> <li>Stabilizing arc with argon and helium</li> <li>Creates fume</li> </ul>	Dissociation energy relatively high, dissociates to carbon and oxygen <ul style="list-style-type: none"> <li>High arc voltage</li> <li>Dissociation is partly endothermic reaction and partly exothermic with less porosity</li> </ul>	High density, molecule of carbon and oxygen <ul style="list-style-type: none"> <li>Good shielding effect</li> </ul>	Good thermal conductivity <ul style="list-style-type: none"> <li>Due to dissociation the gas volume and the pressure increases in arc</li> <li>Good side penetration</li> <li>Bead dome increases</li> </ul>	In single use unstable arc <ul style="list-style-type: none"> <li>Due to dissociation a vertical force occurs</li> <li>Filler spattering in big drops</li> </ul>	Extracted from different chemical processes and power plant fumes, good availability	Inexpensive	3
Hydrogen H <sub>2</sub>	Reductive, burning <ul style="list-style-type: none"> <li>Arc temperature higher</li> <li>Partial component in austenitic stainless steel</li> <li>Good ignition but brittleness effect to be consider.</li> <li>High arc voltage &amp; welding speed</li> </ul>	Low ionization energy <ul style="list-style-type: none"> <li>Dissociation energy</li> </ul>	Low density and small molecular weight <ul style="list-style-type: none"> <li>Partial component in shielding gases</li> <li>When used in small amounts decreases porosity.</li> </ul>	Good thermal conductivity <ul style="list-style-type: none"> <li>Good penetration</li> </ul>	Partial component in small amounts with argon <ul style="list-style-type: none"> <li>Stable, concentrated arc</li> </ul>	H <sub>2</sub> O electrolysis, extracted from different chemical processes, good availability.	Inexpensive	2
Nitrogen N <sub>2</sub>	Reactive <ul style="list-style-type: none"> <li>Builds in higher temperatures nitrides and porosity increases</li> </ul>	Low thermal conductivity	Neutral density	Low thermal conductivity	Used as partial component with hydrogen in root shielding of austenitic stainless	Air separation, good availability	Inexpensive	2
Oxygen O <sub>2</sub>	Oxidizing <ul style="list-style-type: none"> <li>Stabilizes arc with argon</li> <li>Partial component with small</li> <li>Bigger increases oxide</li> </ul>	Low thermal conductivity	Neutral density	Low thermal conductivity	Used as partial component in small amount with argon	Air separation, good availability	Inexpensive	1

The shielding gas selection affects the following factors, Figure 4.33:

- ignition of arc
- stability of arc
- welding speed
- penetration
- shape of weld
- spattering
- visual quality of weld
- mechanical and metallurgic quality of weld
- deposition material behavior and droplet size
- tensions of weld
- weld deformation
- thermal conductivity
- working time
- weld fumes
- weld safety
- weld cost
- right choice of the shielding gas delivery (cylinder/bundle or on-site made mixture)

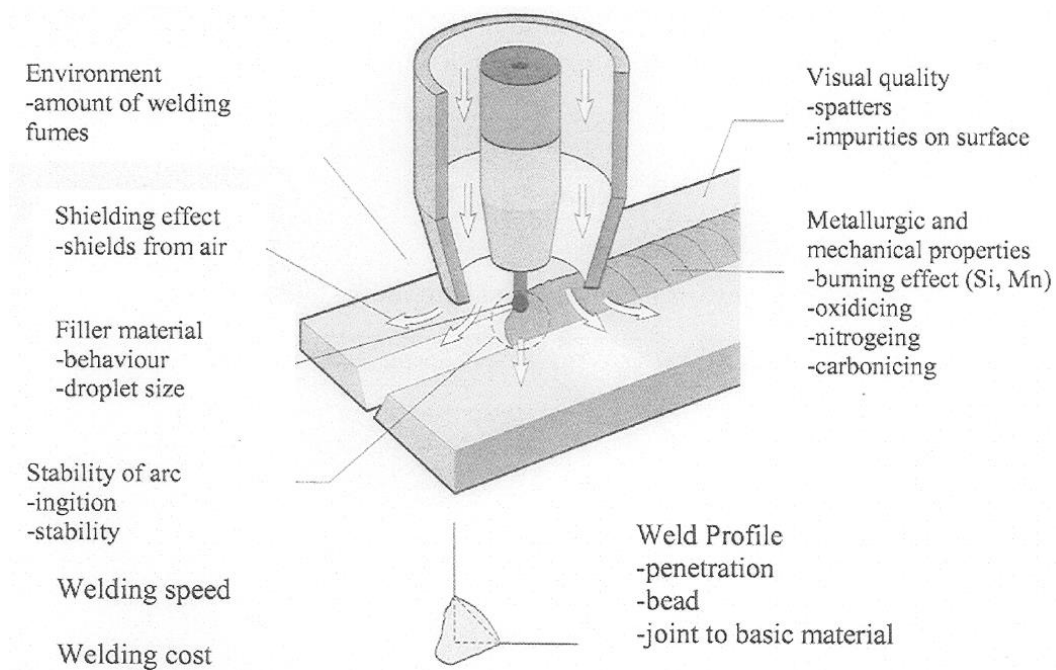

Figure 4.33: The effects of shielding gas in gas arc welding.



#### 4.6.2 The motivating factors of shielding gas in GMAW

The important main features of the shielding gases are molecular weight/density, ionization energy, thermal conductivity, and chemical activity in the welding process.

In gas arc welding 80% of the heat needed to melt the metal derives from the electrical current and 20% from the conducting hot gases. Ionization enables the ignition of the welding arc. Ionization is activated with 5-30% of the required welding current. This is possible because the electron mobility is 100 times greater than the ion mobility. The lowest possible arc temperature level is sought where sufficient amount of electrons is available to carry the welding current. Argon works like this and is therefore an excellent base shielding gas. Helium holds a high ionization energy and needs argon in many gas mixture applications as a partial component for appropriate ignition to take place.

Compared to an argon shielded arc, a helium shielded arc melts more metal at a certain ampere value. Current carries 80% of the heat and 20% of the thermal conductivity of the gas in use. The thermal conductivity is controlled through the mass diffusivity of the atoms with the monoatomic gases like argon and helium. Mass diffusivity is proportional to the inverse square root of the mass of the atom according to the kinetic theory of the gases. An argon atom weighs ten times more than a helium atom. This means the thermal conductivity of argon is only 30% of the thermal conductivity of helium. It can be deduced that helium carries three times more heat across the boundary layer than argon, Table 4.9.

The melting efficiency is quite low in gas arc welding (about 20%). This efficiency can be improved by increasing the heat supply by 40% by using helium shielding instead of argon and thereby double the melted metal volume.

With diatomic gases like hydrogen the thermal conductivity is based on the reactive action in the arc. The gas dissociates in the plasma and is compounded at the boundary layer. With this reactive thermal conductivity the heat supply of gas mixtures such as Ar+5% H<sub>2</sub> is enhanced compared to pure argon gas.

When carbon dioxide, CO<sub>2</sub>, is a partial component in the gas mixture, it is dissociated with the reactive thermal conductivity. In the plasma, dissociation takes place through an endothermic reaction and at the boundary level recombination occurs through an exothermic reaction.

##### 4.6.2.1 Effects of helium on productivity

Commonly, the main component in most shielding gases is argon due to its good shielding properties (high density, inert, low ionization energy, quite inexpensive). Due to these properties argon is also used almost always with helium. Using helium has beneficial effects on the welding speed, penetration, the shape of the weld and the visual quality of the weld, spattering, the heat input and the formation of the material and the safety of welding.

The selection of the right shielding gas or mixture comparing to the material and the welding process is an important factor to productivity. With the right gas selecting the welding speed is higher, the weld joint is smooth with a good metallurgic and mechanical properties and spattering is low. All these factors help the next steps of the production to a good and competitive result.

Pre starting the mass production is recommended to take time and make series of test runs with different test gas mixtures to find the most effective and economical way taking into consideration as well as possible all the variable factors in the welding process.

#### 4.6.2.2 Welding speed increase with helium or helium mixtures

The welding speed increase has been proved with tests to go up from 60 to 150% depending on the welding process and the gas mixture.

#### 4.6.2.3 Penetration

In helium gas mixtures other gases commonly consist of argon, carbon dioxide and hydrogen. Depending on the welding process and the mixture content the arc voltage can be increased, and the penetration can be improved. With the helium mixtures the shape of the penetration is good, and the surface of the weld is smooth.

#### 4.6.2.4 The shape of the weld and visual quality

With the proper mixing of helium in argon and adding smaller amounts of hydrogen and carbon dioxide the profile of the weld is quite flat and smoothly jointed to the basic material without welding failures, Figure 4.34.

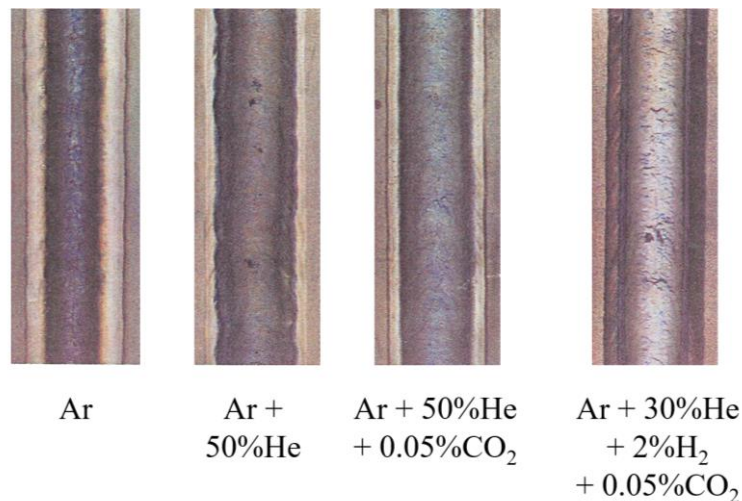

Figure 4.34: Weld appearance with various shielding gas compositions used (Lukkari, 2006).

#### **4.6.2.5 Spattering**

When using helium-argon mixtures the spattering is minimized giving a good welding deposition rate and efficiency.

#### **4.6.2.6 The mechanical and metallurgic quality of the weld with helium**

Helium and helium mixtures have a high thermal conductivity conducting heat and raising the temperature of the arc. By this means helium helps to remove the weld fumes from the arc, spreads the metallic vapours in the arc and increases weld quality from a mechanical and metallurgic point of view.

#### **4.6.2.7 Heat input, welding tensions and deformation of material**

The weld heat input to the basic material is directly dependent on the welding speed. When using argon-helium mixtures with a small amount of carbon dioxide or hydrogen, depending on the welding process, the welding speed can be doubled and thus the heat input onto the basic material is only half that when using a shielding gas without helium. The tensions and the formation of the basic material is also much smaller meaning the improvement of the efficiency avoiding extra work and removal of tensions with other working methods.

#### **4.6.2.8 Weld fumes and safety in welding**

The welding fumes can be minimized by using inert gases and a minimal amount of carbon dioxide. Hazardous ozone is formed in welding stainless steel and aluminium. The creation of ozone can be controlled by using an argon-helium mixture. Helium affects the wave cycle of ultraviolet radiation, thus reducing the production of ozone, Figure 4.35 and Figure 4.36.

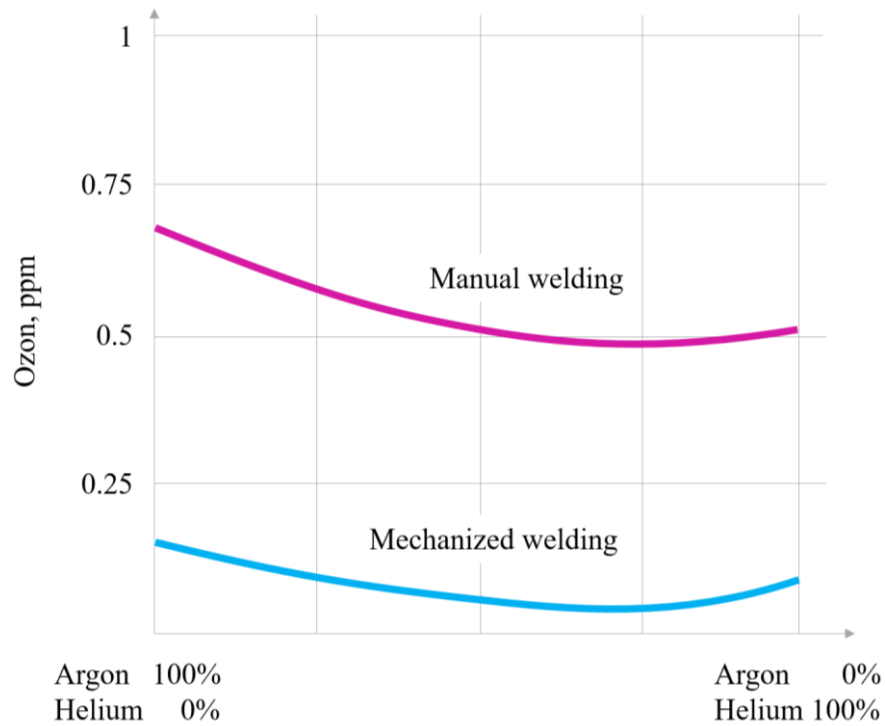

Figure 4.35: The effect of argon-helium mixture on the formation of ozone in austenitic stainless steel welding (Skyddgashandboken, Alfax Sweden).

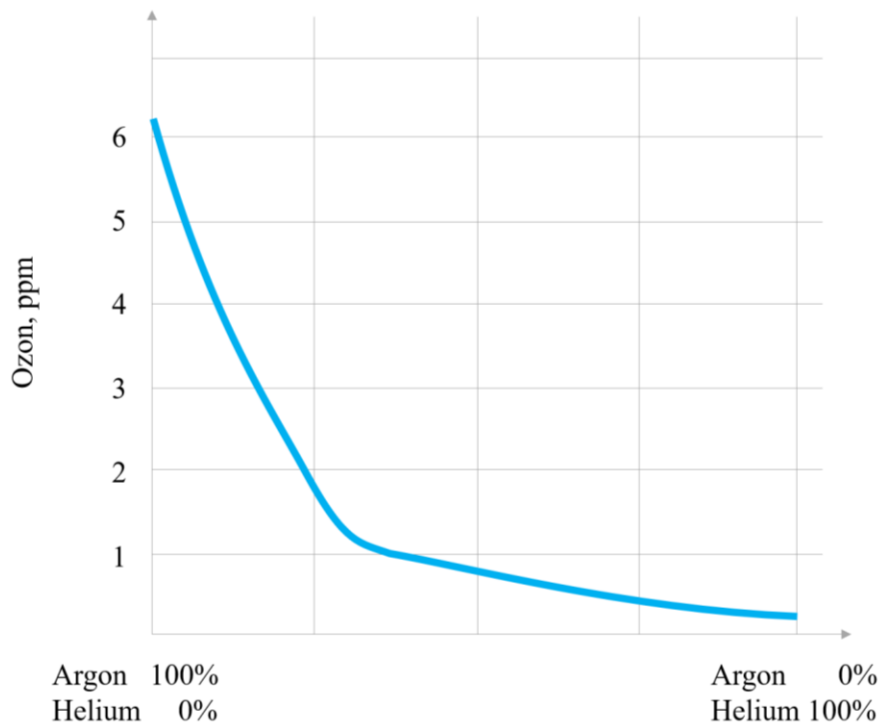

Figure 4.36: The effect of argon-helium mixture to the creation of ozone in aluminium GMAW welding (Skyddgashandboken, Alfax Sweden).

#### 4.7 Welding economy and shielding gas cost

The total cost of welding can be estimated as a summary of different factors. The largest part of the cost is labour. Other expenses are filler materials, service, energy, and shielding gas. Figure 4.37 describes approximate division of manual welding costs.

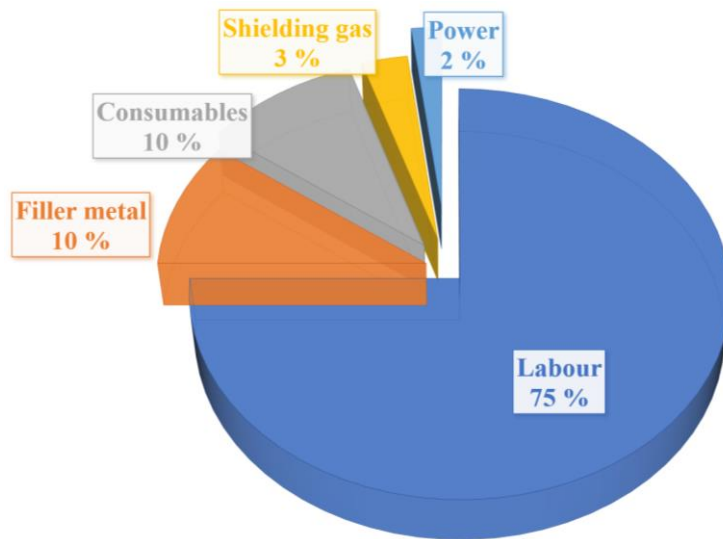

Figure 4.37: Estimated division of manual welding costs (Weman, 2012).

In industrial welding applications the cost of welding depends on various factors, such as the welding process, materials being welded, type of shielding gas, degree of automatization, welder hourly rate and other welding process variables. Figure 4.38 illustrates a typical cost breakdown of GMAW procedures for welding of carbon steel (a) and for welding of stainless steels (b).

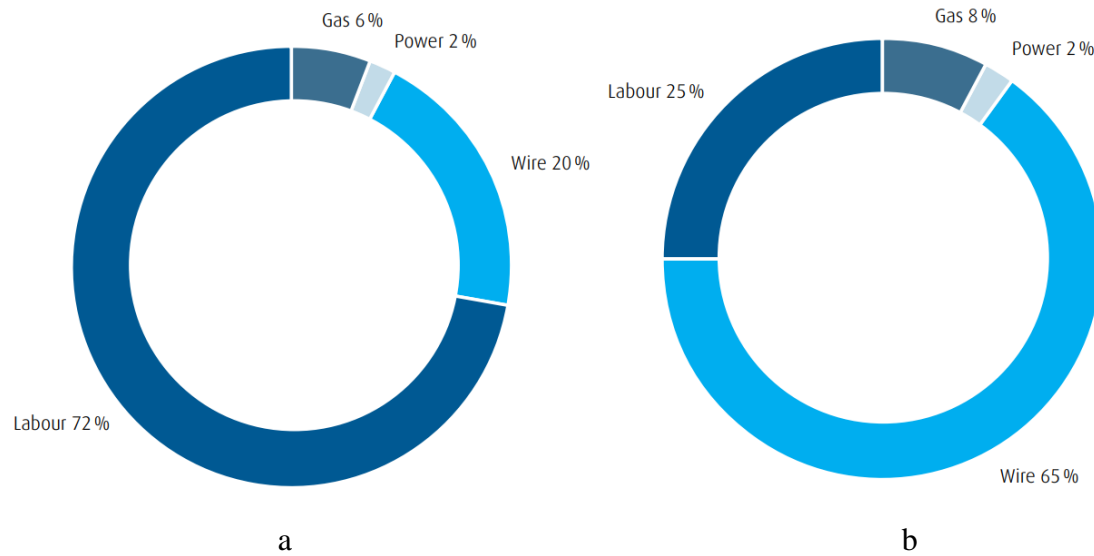

Figure 4.38: Typical cost breakdown of GMAW procedures. (a) Welding of carbon steel. (b) Welding of stainless steels (The Linde Group, n.d.).

Generally, the direct cost of the shielding gas is not remarkable in the total welding process (only 6% to 8%), but an inappropriate selection of gas or its components, incorrect operating values and other indirect costs can create extra costs which may be two to three times the direct gas cost.

Shielding gas costs consist of direct and indirect costs. The direct costs comprise the actual gas price, rental cost of cylinders or tanks, the costs of gas delivery and transportation, including workshop gas pipeline system installation and maintenance associated costs.

Indirect shielding gas costs include consequences of gas leakages, costs associated with change of the cylinders, and shielding gas selection which influence the ignition of the arc, welding speed, depth of penetration, spattering, heat input, weld deformation and weld tensions, arc time relation, and other parameters. Additionally, the choice of shielding gas affects the welding safety associated costs.

Table 4.10 describes the relative cost of different shielding gases. The shielding gas cost delivered in gas cylinders or cylinder bundles is more than double to that of on-site shielding gas production. The cost of helium or helium based shielding gas mixtures is double or triple when using pure helium compared to argon or argon-carbon dioxide mixtures in a cylinder or cylinder bundle application. With the on-site system the price differences are not so big, about 70 - 80 % more and therefore helium base mixtures can be recommended when seeking welding productivity and efficiency, and especially for larger, automated processes.

Table 4.10: Relative cost comparison with different shielding gas per Nm<sup>3</sup> in Finland.

Relative price per Nm <sup>3</sup> (Including gas price and rentals)	CO <sub>2</sub>	Ar	Ar + 2 % CO <sub>2</sub>	Ar + 8 % CO <sub>2</sub>	Ar + 18 % CO <sub>2</sub>	Ar + 25 % CO <sub>2</sub>	Ar-He Ar + 30 % He	Ar + 5 % H <sub>2</sub>	Helium N46 (99,996 %)	Ar + 30 % He + 10 % CO <sub>2</sub>	Formier N <sub>2</sub> +12 % H <sub>2</sub>
Gaseous cylinder – or bundle delivery, consumption 3000 Nm <sup>3</sup> /a	0,32	1,4	2,26	1,06	1	0,97	1,87	2,30	4,8	2,5	0,80
On-site liquid delivery + mixing components + mixing unit, consumption 10 000 m <sup>3</sup> /a	0,20	0,50	0,48	0,44	0,4	0,38	0,70	0,6		0,80	0,30

Helium is an expensive gas, but it has special properties that deliver advantages and savings to the selected welding process. Helium based shielding gases can improve many factors increasing the productivity and thereby reduce the total cost of the weld, even though the direct cost of the helium mixture is higher.

#### 4.8 Health and safety

In the welding environment, sources of substances that can be a respirable hazard include:

Welding:

- the base metal
- the filler and its flux
- shielding gas
- the action of the heat source on the environment
- surface contaminants and coating

Grinding dusts;

The welding environment itself, which may be deficient in oxygen, or contain asbestos, chemical hazards, oils, etc.

The welding fumes, when inhaled have the largest adverse effect on the welder’s health. The welding fume composition varies according to the welding process and typically contains metal oxides and other metal reaction products, particulate from flux of electrodes and gases produced by UV light like ozone and shielding gases. Fumes may contain fine dust mass fraction that accumulate in the lungs and remain in the body. About 90% of the particles contained in the welding fumes derive from the welding consumables (Blunt & Balchin, 2002). Figure 4.39 illustrates welding fumes particles compared with other particles.

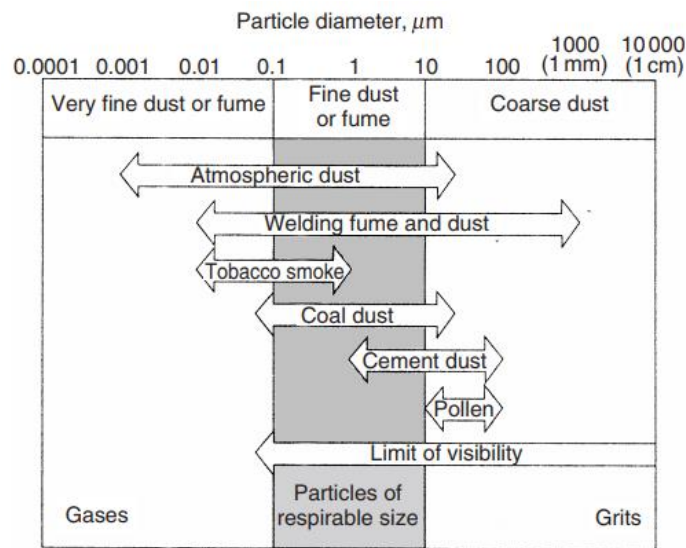

Figure 4.39: Natural and industrial particle size in smoke (Blunt & Balchin, 2002).

Standards set the Maximum Allowable Concentration (MAC) of welding fumes, which is the average concentration allowed for inhaling during an 8-hour workday and a 40-hour work week, to which a worker may be repeatedly exposed without adverse health effects.

Exposure to different types of welding fumes may result in various health effects which may vary depending on the duration of exposure. Table 4.11 lists negative health effects of inhaling various fumes and dusts on a short and long term.

Table 4.11: Health risks of inhaling welding fumes (Blunt & Balchin, 2002).

Fume/Dust	Possible immediate effects	Possible long-term effects
Welding fume (general)	Hoarseness, sore throat, eye irritation, metal fever	Bronchitis, reprotoxic, carcinogenic



Chromium (in stainless steel welding)	-	Carcinogenic
Nickel (in stainless steel welding)	Metal fever	Carcinogenic
Aluminium	Irritation of respiratory organs, metal fever	
Manganese	Pneumonia	Damage to central nervous system
Zinc	Metal fever	-
Copper	Metal fever	-
Magnesium	Irritation of respiratory organs, metal fever	-
Lead	-	Changes in blood and kidneys. Reprotoxic

Shielding gases argon, helium and carbon dioxide are released into the atmosphere and may build up where ventilation is restricted e.g. inside the tank in welding process, or with argon and carbon dioxide even in open topped tanks because they are heavier than air. These gases present the range of hazards associated with their release in closed space and under certain circumstances can present an asphyxiation hazard. Entry into an area with a high concentration of these gases (and hence a low concentration of oxygen) can cause unconsciousness, without any warning signs being noticed by the victim. The simple device to protect the worker is an oxygen meter which indicates the oxygen level and alarms when it goes under the setpoint. Exposure to excessive carbon dioxide levels can cause headache, dizziness, tinnitus and raised respiratory rate with difficulty in breathing. CO<sub>2</sub> is supplied liquid form in cylinders at about 50 bar pressure. The cylinder is filled to 75% level with liquid and at the top is 25% gaseous gas. The cylinder must be handled in standing position to get the gaseous CO<sub>2</sub> to the pressure regulator. (Blunt & Balchin, 2002). Table 4.12 explains harmful effects and provides exposure limits of various gases used in welding and allied industrial processes.

Table 4.12: Harmful effects and exposure limits relating to gases and vapours (HSE, 2005), (US Department of Labor, 2017).

Substance	Common sources	Possible adverse effects	Exposure limit (Europe), ppm
Argon, helium	Shielding gases	Asphyxia	-
Carbon dioxide	Shielding gas, combustion of fuels	Asphyxia	5000

Carbon monoxide	Partial combustion of fuels, decomposition products	Block the attachments of oxygen to hemoglobin	30 (long term) 200 (15 min)
Oxides of nitrogen	Action of welding torch on the gases in the air	Pulmonary edema, which may be fatal. Shortness of breath, coughing, etc.	3 (long term) 5 (15 min)
Oxygen	Accidental release	Accelerates fire	-
Ozone	Action of UV on air near the weld.	Irritant. In excess causes pulmonary edema.	0.2 (15 min)
Phosgene	Action of arc on chlorinated degreasing compounds	Highly toxic, produces hydrogen chloride in the lungs	0.02 (8 hours) 0.06 (15 min)
Trichloroethylene	Degreasing	Mildly toxic	100

Arc welding produces large quantities of light, from the ultraviolet (UV) to infrared radiation. UV radiation from a welding arc is intense – for example, a metal inert gas MAGW using helium gas running at 300 A typically produces  $5 \text{ Wm}^{-2}$  in the UVB and UVC at distance of one meter. This is many times the intensity of the sun at noon. The visible radiation is also intense. Oxyacetylene welding produces less UV light, but still produces substantial quantities of visible and infrared radiation.

## 5 Helium recovery system design

### 5.1 Collecting and recovery model

The permanent fluctuation in the availability of helium has led to the activation of various collection and recovery models in different applications. Currently, MRI applications account for the most extensive use of helium. The collection of helium from the exhaust pipeline of MRI units is technically the easiest recovery system because the exhaust gas mainly contains helium and small amounts of air and moisture. That is why the largest helium users in the MRI field are constructing recovery systems including liquefiers on-site. They only need a small portion of extra liquid helium to replace the losses.

Another method for utilizing the exhaust gas is to pressurize the helium flowing from the exhaust line to high pressure cylinders or cylinder containers and transport it back to the gas factory, where the impure gas is purified and re-liquefied, impelled into liquid helium dewars, and delivered back to the customer. The efficiency of this collecting and reusing system is as high as 70 - 80% and is significant in the total cost structure (Korjala, et al., 2017).

15-20% of the global helium consumption is in welding applications. Environmental aspects and the necessity of reducing the CO<sub>2</sub> footprint motivate the development of recovery systems in welding applications. The most beneficial applications to initiate the use of recovery systems are automated processes which use large volumes of inert gases argon and helium such as laser, hybrid, and high-performance welding.

Figure 5.1 describes the schematic flow scheme of the collecting and recovery system. The idea is to collect all the fumes, purify them from particles and impurities and utilize the valuable substances, especially helium and other shielding gases. The analysed recovery gas is blended into the shielding gas process flow through an automated mixing unit.

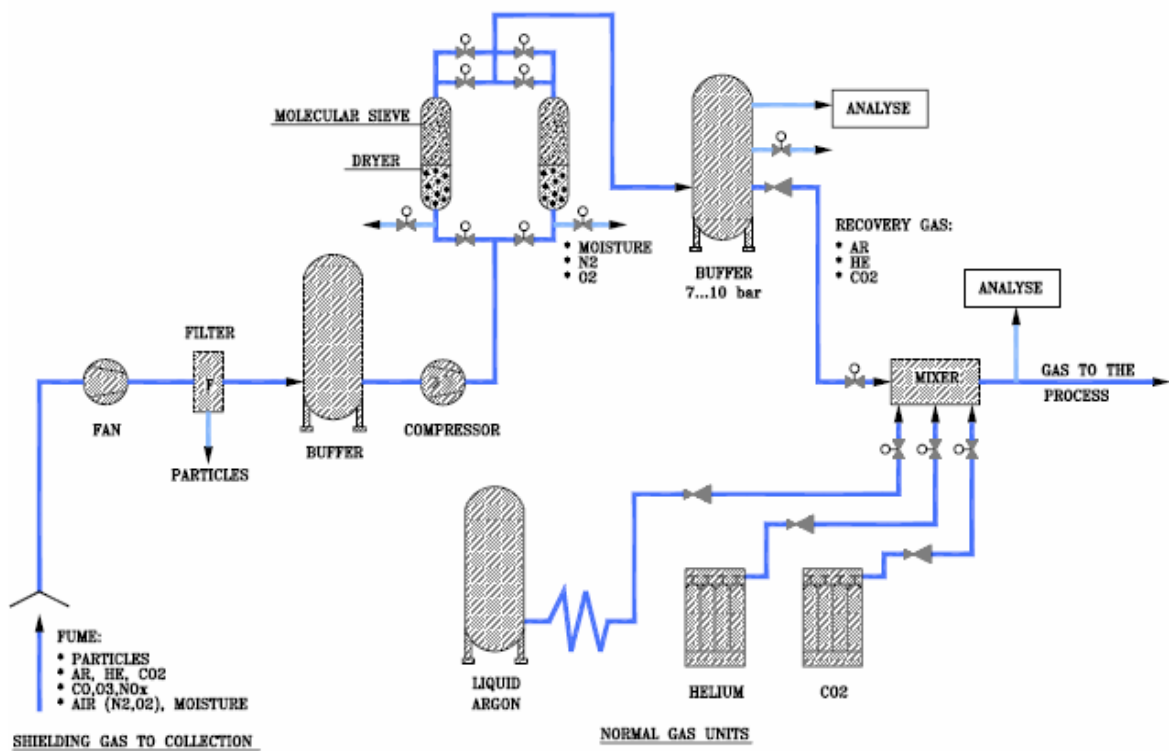

Figure 5.1: The principle of the shielding gas collecting and recovery system.

## 5.2 Weld fume specification and compounds

In different welding applications, approximately 2% of the workers (about 3 million persons) are exposed to potentially hazardous welding fumes. In confined places where ventilation is inadequate the fume compound can exceed the determined maximum health and safety (HSE) limits to the worker.

The main activating causes and features in the welding fume emissions are the:

- welding process
- base material
- filler material
- shielding gas
- welding parameters: welding current and arc voltage
- coating of base material

The compounds and the hazardous effects of the fumes are dependent on the welding process, filler material and the base material. The main causes as shown in Figure 5.2 occurring in the fumes are:

As particles:

- iron oxide, manganese oxide, chrome, nickel, copper oxide, lead oxide and aluminium oxide which create metal compounds in the fumes
- fluorides from the flux core wires
- in stainless steels: molybdenum oxide, chromium (VI) compounds and nickel and cobalt compounds

As gaseous elements:

- carbon monoxide, nitrogen compounds ( $\text{NO}_x$ ) as nitrogen oxide and nitrogen dioxide and ozone near the arc
- with coated plates: the evaporated gases and vapors
- shielding gases

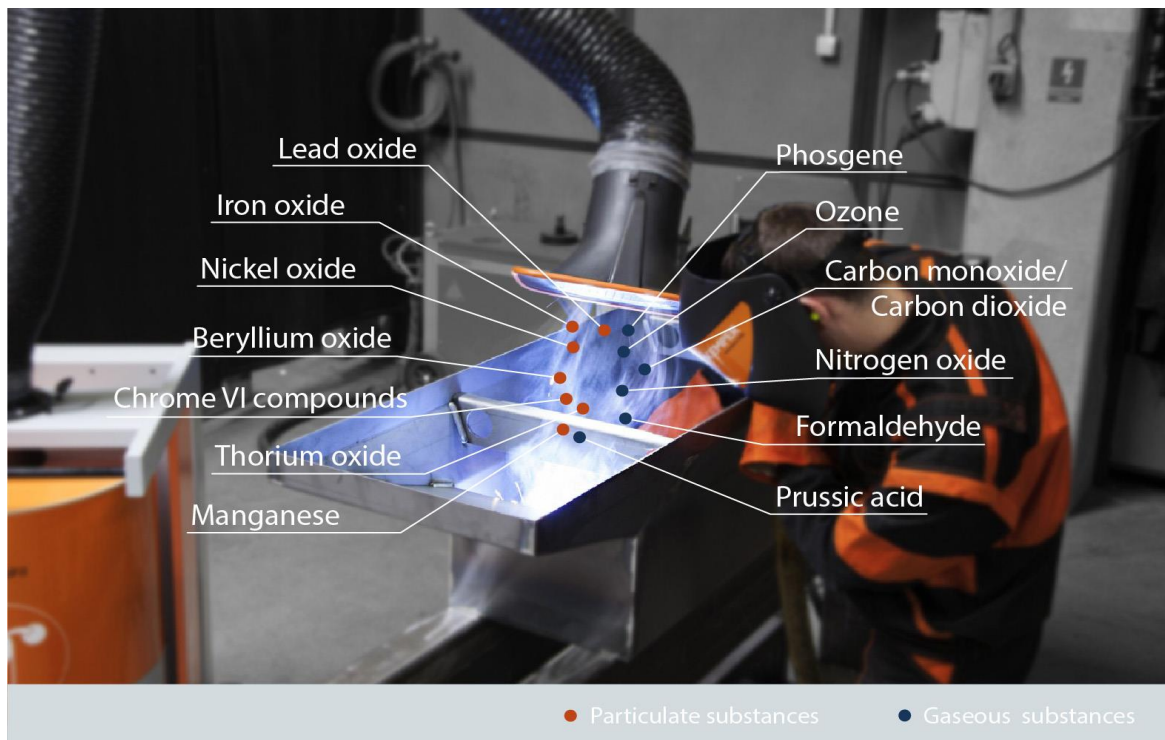

Figure 5.2: The fume compounds in gas arc welding (Kemper America, 2018).

In carbon steel welding, manganese is the most important component in the fumes. The concentration varies between 2-15%, depending on the welding process and the filler material. The volume of manganese in the fumes is greater than in the filler material where it is normally 1-2%. The reason for the high content is the relatively low boiling point of carbon, when compared to other metals.

Ozone (O<sub>3</sub>) is created near the welding arc when the oxygen atom, O, reacts with the oxygen molecule, O<sub>2</sub>. The reactive action takes place near the arc by the effect of ultraviolet (UV) radiation at the wavelength less than 250 nm. Ozone is a light blue, tangy smelling, and poisonous gas. The hazardous content inhaled is 0.2 ppmv, at 15-minute exposure and 0.05 ppmv at 8-hour exposure.

Ozone concentration in the gas arc welding can be reduced with the following procedures:

- local fume collection and ventilation
- the welder operates wearing a ventilated shield helmet
- avoiding welding positions in the emission cloud
- welding parameters are adjusted properly
- use of shielding gases avoiding the UV radiation with wavelength less than 250 nm

Gaseous emission in fumes also include nitrogen compounds (NO<sub>x</sub>) and carbon monoxide (CO).

In GMAW welding more than 90% of the welding fumes is generated from the filler metal material and less than 10% is from the parent material. Most of the particles are smaller than 1 micron and the particles appear in a cluster form. The welding fume particles are compared to other fumes in chapter “Health and Safety”. Part of the particles can penetrate the alveoli through breathing.

### **5.3 Description of the recovery unit and running**

#### **5.3.1 Weld fume extraction system**

The fumes are sucked from around the torch and arc through the collector to a duct with a fan unit that creates a slight vacuum within the collector. The fan is equipped with a frequency driver and connected to an automated loop to get the input from the shielding gas feeding pressure. The fume extraction process must not disturb the shielding process on the arc.

Beneficial extraction systems should make the work easier for the welder and for the process in operation. A correctly designed exhaust hood collects the fumes effectively facilitating maintenance of the welding place environment and securing occupational safety.

The best extraction performance and the best available filter technology are ineffective if the welding fumes do not find their way into the exhaust system. The exhaust hood plays a fundamental role in extraction, as well as the filter technology. A correctly designed exhaust hood also contributes to the tendency for welders or for the welding process to increasingly utilize extraction and filter technology correctly.

Figure 5.3 describes the principles of hoods that are efficient for fume collecting and enhancing occupational safety, while promoting the effectiveness of the recovery systems. For effectively collecting welding fumes the exhaust hoods should meet the following criteria:

- Simple tracking ability increases the likelihood to recover the fumes
- Designed for the welding application to have a 360-degree swiveling exhaust hood with a throttle cover.
- The suction arms should be self-supporting
- A flange-shaped cover on the sides prevents suctioning air that does not belong in the funnel. Hereby the hood achieves higher collection range compared to a simple oval hood.
- The flange-shaped exhaust hood is positioned 100 percent along the welding seam. This ensures a minimum amount of back-tracking.

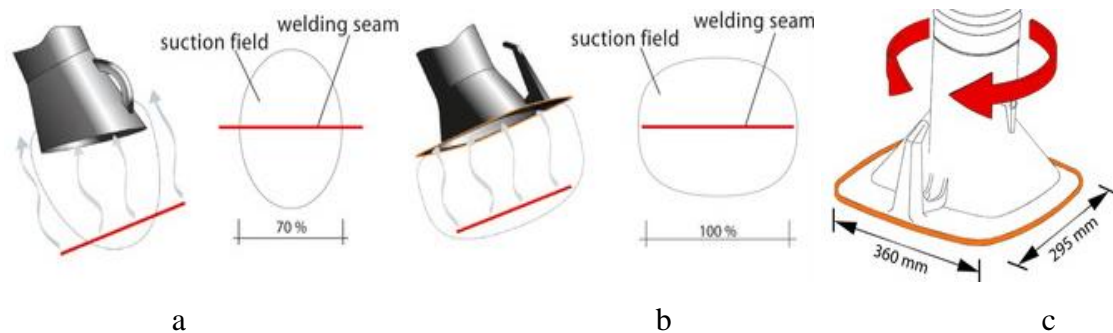

Figure 5.3: The exhaust hood designs. (a) Conventional oval exhaust hood. (b) Exhaust hood with flange shaped overlap. (c) Exhaust hood dimensions (Timings, 2008).

Exhaust hoods are used for low-vacuum spot extractions. They are widely used in both hand welding and automated welding applications.

### 5.3.2 Particle removal with filters

The fume is lead to a particle filter unit comprising two vessels filled with suitable filter mass to remove the particles, mostly smaller than 0.25 microns and cluster shaped. Using two filters is efficient because one is in an operation while the other is in purification or service mode when it is either automatically regenerated by removing the particles from the vessel or the filter is changed. This purification mode or the filter change is done based on time. The purification frequency depends on the particle saturation of the filter unit. One way to control it is to monitor the pressure drop inlet/outlet of the filter vessel.

### 5.3.3 Filtering systems

The filtration efficiency is classified into one of three welding fume filtration classes.

The welding fume filtration class—the so-called W-class—let you read the filter performance on the label. The limit for respirable dusts that settle on the alveoli determines which filter performance is required. It depends on the material being welded as well as the welding process being used.

While the limit for inhalable dust in the work area—which appears in a particle size of up to 100 microns—must be under 10 milligrams per cubic meter, the highest limit for respirable dust—at a size of up to 10 microns—must be under 1.25 milligrams per cubic meter. Companies must reduce ultrafine dust particles to a legal minimum if they are not eradicated altogether. However, these unwanted nanoparticles which appear in a size of less than one tenth of a micron, cannot be collected.

“Technical Regulations for Hazardous Substances – Air Return When Handling Carcinogenic Substances” (TRGS 560) is authoritative for welding fumes containing carcinogenic substances such as nickel oxide or chromium (VI) compounds. Welding fume extraction devices in Filtration Class W3 meet the requirements for purified air return in accordance with TRGC 560, as they were approved by the Insurance Institute for Occupational Safety (IFA) and grouped accordingly on a positive list (Kemper America, 2018).

### **The W Classes:**

Testing of extraction devices takes place according to DIN EN ISO15012-1 “Occupational Health and Safety for Welding and Related Processes – Requirements, Testing and Labeling of Air Purification Systems – Part 1: Specifying Filtration Efficiency for Welding Fumes.” The classes can be summarized by the following characteristics (Kemper America, 2018):

#### **Class W1**

Filtration efficiency must be at least 95 percent or greater. Filters in this class are suitable for unalloyed or low-alloyed steel.

#### **Class W2**

Filtration efficiency greater than 98 percent: steel alloys with nickel and chromium components (5 to 30 percent composition) may be welded with this filter.

#### **Class W3**

Filters with a filtration efficiency greater than 99 percent: these filters must be used when working with high-alloy steel containing more than 30 percent nickel and chromium.

The filter technology is decisive in determining the longevity of an extraction unit. The elementary extraction of hazardous substances is decided inside the device. A major factor in determining service life whether it should be a storage filter (changed after a certain time) or an extraction unit with a filter to be purified from time to time.



The correct filter technology for the respective requirements of the welding company depends on the duration of use. When it comes to extraction in heavily fuming processes, there is no alternative to re-purified filter media. If fumes emission is comparatively low and the unit is only used for a few hours a day, the less expensive filter unit with storage filters may be the right choice.

The differences in approach mean that the two filter types need to have different characteristics. Disposable filters function on a principle of depth filtration and re-purified filters involve surface filtration.

As the name suggests, storage filters need to be replaced at some point. The filter technology in the extraction unit must therefore be designed in such a way that it can store as many hazardous substances as possible – and ideally over a long period of time in order to keep the costs for new purchases low. To guarantee this, the filter area must be as large as possible. They are therefore designed in such a way that the fine dust particles captured during welding fume extraction reach the inside of the filter medium.



Figure 5.4: Changeable Storage filters.

This depth filtration is designed three-dimensionally to achieve a maximum dust storage capacity. If the particles were to collect exclusively on the surface, the filter medium for storage filters would quickly become clogged. However, with storage filters, filter medium composition is such that the particles can penetrate the interior of the filter medium. They are deposited there over time and the filter becomes increasingly saturated, from the inside outwards, until a filter change becomes necessary and is indicated on the extraction unit by pressure drop.

If welding is done with high intensity and it generates large quantities of welding fumes, a larger filter area is needed. The larger the filter surface is, the greater the dust storage capacity of the filter and its lifetime before the next filter change in the service.

Re-purified filters have a long operating time. This solution is good if the fume quantity is relatively small and/or the operating period is limited. The investment cost is higher for re-purified filter units than the changeable storage units.

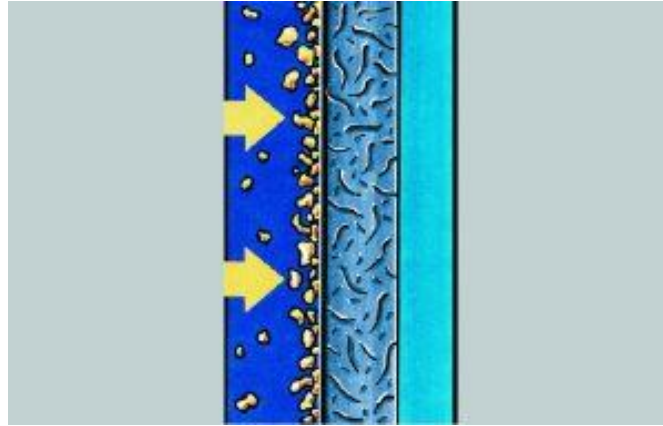

Figure 5.5: Surface of regeneration filter.

To allow cleanable filters to remove the hazardous substances during the cleaning process the fume particles must not penetrate deep into the filter material. The reason for this is the regeneration process which is done with compressed air or nitrogen. The fume particles must be released during the regeneration cycle time and if they are deeply immersed inside the filter material this does not happen. Therefore, the operating cycle cannot be too long.



Figure 5.6: Filter cartridge.



Figure 5.7: Rotating pressurized air cleaning nozzle.

It is important to capture the particles directly on the surface of the filter material. Under a microscope, this surface looks like a tangle of ultra-fine fibers. This tangle is meant to be as dense as possible. Technically particularly good, but difficult to produce is a laminated, stretched Teflon membrane (ePTFE membrane). It has fine pores and Teflon is dirt-repellent.

The operational requirements are based on the cleaning and regeneration cycles. This can be done by pulse cleaning with compressing and relieving air into the filter unit. This is an effective and relatively inexpensive method. Another cleaning system is to use air-driven rotary nozzles. Figure 5.7. Heavy welding metal shops where abundant fumes are generated, use this kind of cleaning solution in their processes.

Oil mist is a difficult substance to remove from the filtering units. The Teflon membrane filters which are regenerated do not work with oil mist. In welding applications where oil mist is created, such as the automotive industry where spot welding is used, additives to clean the filters or changeable storage filters are used.

#### 5.3.4 Compressing unit

After particle removal, the fumes are stored in a buffer unit which is a steel vessel, or a special flexible balloon designed for this kind of gas mixture handling. The next unit is a compressor operated with a frequency driven electrical motor that sucks the fumes from

the buffer unit compressing to a range of 10 bar pressure. The start-up input impulse to the compressor is generated by the high-pressure buffer vessel located after the purification unit. The pressure varies between 7-10 bar. The compressor start-up is at 7 bar and stop at 10bar.

The most suitable compressor for fume composition compressing is a piston or membrane type compressor.

### 5.3.5 Dryer and molecular sieve units

From the compressor the pipeline leads the fumes to a double-column dryer/molecular sieve purifier. The dryer columns are filled with moisture removal mass and an appropriate molecular sieve mass to remove oxygen and nitrogen molecules with time base operating cycles. One column is in operation while the other is in regeneration mode purging out water, oxygen, and nitrogen molecules.

The dryer unit can be a separate vessel or a combination with the molecular sieve unit. In the first stage a separate unit would be the better solution. The dryer removes the water molecules out of the fume gas stream. Two vessels are required in the unit working with time cycles, one side in operation another side in regeneration. The regeneration is done by taking a small portion of the dry gas from the outlet of the operating dryer. The drying mass material is either silica gel or molecular sieve.

The molecular sieve two column vessels operate simultaneously at the time cycles with the dryer unit. Different dryer mass options remove the water molecules from the fume gas flow. The first option is to use silica gel mass. The molecular sieve is a material that contains precise and equal tiny pores which absorb gases and liquids, Figure 5.8.

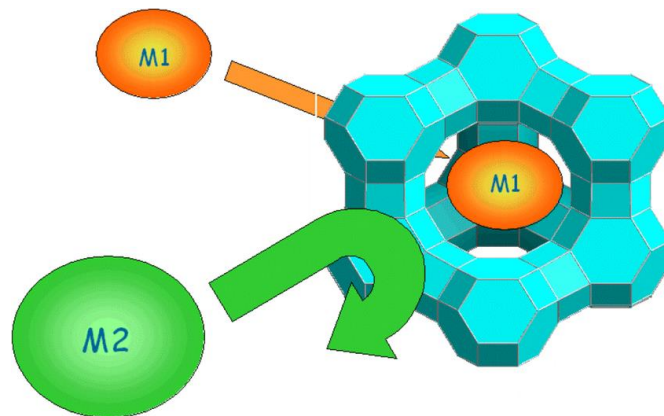

Figure 5.8: The function of a molecular sieve. (Max Planck Institute, Germany)

The molecular sieve or absorbents can be retrieved from the earth as zeolites. 245 unique framework structures have been identified and by 2018 40 different structures were known which occur naturally.

Zeolites used as molecular sieve adsorbents can be classified according to different identified types. Each type has special features for adsorbing different material and molecules.

A natural aluminosilicate is found in the earth with effects such as molecular sieving, adsorption, ion exchange, and catalysis, referred to as a zeolite. This natural substance can also be synthetically produced, the result being referred to as a molecular sieve.

The chemical composition formula of zeolite:  $(M^{n+})_{2/n}O \cdot Al_2O_3 \cdot xSiO_2 \cdot pH_2O$ , M represents a metal ion (usually Na in artificial synthesis), where N represents a metal ion valence, x represents the number of moles of  $SiO_2$ , also known as silica to alumina ratio, p represents the number of moles of water. The most basic structure of the crystalline zeolite backbone is the tetrahedra  $SiO_4$  and  $AlO_4$ , through the binding of common oxygen atoms to form crystals with three-dimensional network structure. This combination constitutes cavities and channels of molecular level and uniform pore size. Owing to the different structures and different forms, "cage" shaped holes can be divided into  $\alpha$ ,  $\beta$ ,  $\gamma$ , hexagonal prism and faujasite. The structure of the most common zeolites, Type A and Types X and Y determine the absorption capability of the molecular sieve. The crystal structures of A-type, X-type, and Y-type zeolites are shown in Figure 5.9.

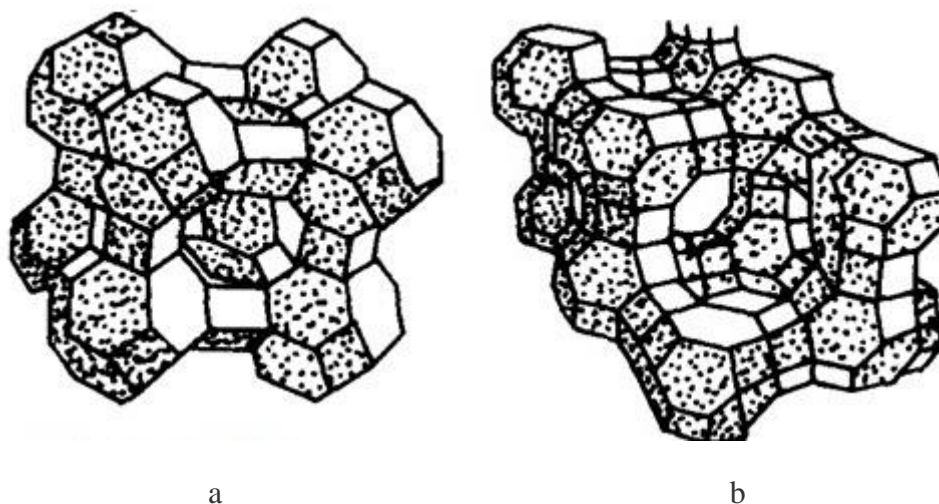

Figure 5.9: Crystal structures. (a) A type zeolite. (b) X and Y-type zeolite.

Because  $AlO_4$  tetrahedron has a negative charge, it can bind to sodium ions to become electrically neutral. In aqueous solution,  $Na^+$  can be easily exchanged with other cations. Most types of molecular sieve catalysts are the exchanges of polyvalent metal cations or  $H^+$ . Zeolite retains its acidity and selectivity at a molecular size and can be used as a catalyst or carrier. Silicon and aluminium atoms, by constituting the oxygen ring through oxygen atoms, determine the zeolite pore aperture. The number of oxygen atoms per oxygen ring is 4 to 12. Generally, varieties of adsorbing effects contain an eight-membered ring (0.4 ~ 0.5 nm), 10-membered ring (0.5 ~ 0.6 nm), and 12-membered ring (0.7 ~ 0.9 nm).

Varieties comprising a twelve-membered oxygen ring contain Y zeolite ( $x = 3.1 \sim 6.0$ ) and mordenite ( $x = 9 \sim 11$ ). The former can be used as a cracking catalyst and bi-functional catalyst while the later one can be used as a toluene disproportionation catalyst. To adsorb, the ten-membered oxygen ring includes ZSM-5, ZSM-11 and some ZSM series zeolite.

Eight-membered oxygen rings include Zeolite A ( $x = 2$ ), T-type zeolite and ZSM-34 and the like. Their pore is minimal allowing only straight-chain hydrocarbons to enter the pores. A catalyst with a molecular sieve as the catalytically active component or as major active component is known as a molecular sieve catalyst. A zeolite possesses good ion exchange properties, uniform molecular pore size, excellent acid catalytic activity, good thermal stability, and hydrothermal stability. It can be produced from catalysts with high activity and selectivity towards many reactions.

Molecular sieves can be widely used as a solid adsorbent in the chemical industry, petroleum industry, and other relevant departments and experiments. After appropriate treatment (e.g. heating) desorption of the adsorbed substance can be done through a process referred to as "regeneration", and the molecular sieve can be reused. Molecular sieves can be used for drying of both gases and liquids and the dehydration of the compound (the crystal water, or the hydroxyl and hydrogen atoms in two close compound molecules, are removed in the form of water). Selecting the molecular sieve of appropriate molecular pore size can adsorb a specific substance in the mixture to achieve the purpose of isolation or purification.

Specified different types and their adsorb applications include:

**Type 3A:** Will remove most molecules except water. Type 3A is used for drying natural gas, ethanol, olefins, etc..

**Type 4A:** The sodium form of Type A is widely used as a drying agent to remove water molecules. Under certain conditions it can also be used for removal of carbon dioxide.

**Type 5A:** This is the calcium-exchanged form of Type A zeolite. The strong ionic forces of the divalent calcium cation result in 5A being an excellent choice for removing carbon dioxide, carbon monoxide, hydrogen sulphide and other weakly polar molecules. This product is also effective for the bulk separation of iso-paraffin hydrocarbons.

**Type 13X:** The sodium form of zeolite X has a much larger pore opening than Type A crystals. It also has the highest theoretical capacity of the common adsorbents and very good mass transfer rates. Type 13X removes impurities too large to fit into the Type A zeolites and is also often used to separate nitrogen from air to produce a high purity oxygen stream.

**Type Y:** Similar in structure to the Type X, Type Y has a higher silica to alumina ratio, offering some improved adsorption of hydrophobic compounds and imparting some acid resistance.

The molecular size of different chemical elements varies and depending on this the molecular sieve pores capture one chemical element molecule while other molecules pass through it.

In Table 5.1 describes the sizes of common gases and liquids with the critical diameters referred to as Ångstrom (Å). One Å is 0.1nm.

Table 5.1: Molecular sieve selection to fume purification. (Merck, SigmaAldrich)

Molecule	Critical diam. (Å)	Molecule	Critical diam.(Å)
Helium	2.0	Propylene	5.0
Hydrogen	2.4	Ethyl mercaptan	5.1
Acetylene	2.4	1-Butene	5.1
Oxygen	2.8	<i>trans</i> -2-Butene	5.1
Carbon monoxide	2.8	1,3-Butadiene	5.2
Carbon dioxide	2.8	Chlorodi fluoromethane (Freon 22 <sup>®</sup> )	5.3
Nitrogen	3.0	Thiophene	5.3
Water	3.2	Isobutane to isodocosane	5.6
Ammonia	3.6	Cyclohexane	6.1
Hydrogen sulfide	3.6	Benzene	6.7
Argon	3.8	Toluene	6.7
Methane	4.0	<i>p</i> -Xylene	6.7
Ethylene	4.2	Carbon tetrachloride	6.9
Ethylene oxide	4.2	Chloroform	6.9
Ethane	4.4	Neopentane	6.9
Methanol	4.4	<i>m</i> -Xylene	7.1
Methyl mercaptan	4.5	<i>o</i> -Xylene	7.4
Propane	4.9	Triethylamine	8.4
<i>n</i> -Butane to <i>n</i> -docosane	4.9		

The appropriate molecular sieve combination can be found by testing to remove air (N<sub>2</sub> and O<sub>2</sub>) and water molecules out of the gas flow and let helium and possibly also argon molecules pass through the unit.

Considerable development work is ongoing with synthetic molecular sieves. The pursuit to produce absorbent material from waste materials is active, presenting an opportunity to recycle materials in zeolite fabrication, thus introducing an environmentally friendly solution for the molecular sieve selection. This option would support the target of this thesis to encourage recycling in all use of materials.

In this thesis experimental tests were made by molecular sieves to test the removal of different welding fume components.

### 5.3.6 Buffer tank and analysing

The purified gas is collected from the molecular sieve and led to a pressure buffer vessel equipped with an on-line analysing device. The buffer vessel pressure varies between 7 bar to 10 bar. If the gas quality is within the determined specifications and approved for use, it is delivered to the mixer unit; if not, the gas is released out of the buffer or diluted with the pure gases coming from the pure gas storage. This results in raising the quality level to a range acceptable for the mixer unit.

A wide range of options for analysing devices is available, the most simple ones based on the thermal conductivity of the sample gas and the reference gas (Figure 5.10). The reference gas is pure helium with 99,999% purity, the accuracy of this method is at the range of 0.1% which is a sufficient level in helium recovery systems for welding applications.

The most sophisticated helium analysers are operated by detectors that detect the ionization current produced by the ionized molecules. Ionization takes place with a high frequency plasma producing a high energy photon emission (24,5eV). This emission can ionize all gases within the measuring cell except for helium and by this means the other components can be measured.

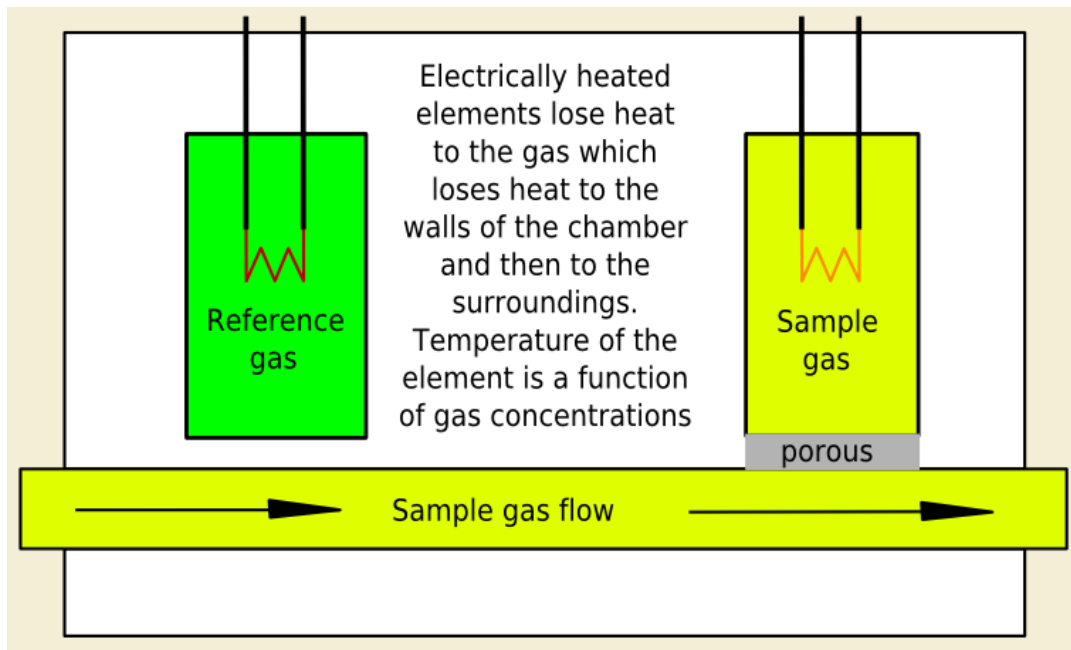

Figure 5.10: Helium analysing by thermal conductivity. The sample gas diffuses through the porous barrier into the sample chamber.



### 5.3.7 Mixer unit

The mixing unit is a manual or an automated device which blends the required mixture into the production process. The working principle is to deliver the gas from both the pure gas liquid or gaseous gas storages and the recovery gas buffer vessel, equalize the pressures and mix the blend.

The heart of the gas mixing unit is the mechanical proportional mixing valve. This enables the reliable creation of gas mixtures in a precise and stable manner. With two gas mixtures the valve has 2 gas inlets and one outlet. By turning the knob the adjustment of the valve engages the orifice and piston to proportionally regulate the flow rate of the individual gases to create the required gas mixture.

In mixtures comprising 3 or more gases, individual mixing valves are used instead of proportional valves, Figure 5.11. The flow rate of the individual gases is determined separately with a mechanical mixing valve. The mixture therefore comprises separately dosed individual gases.

Mixing can also be done by an automated valve system which works the same way as the mechanical mixing valves but is operated by an automatic controller.



Figure 5.11: Three gas mixing unit. (Witt, Germany)

From the mixing unit the mixed gas is led to the buffer tank between the mixing unit and the gas delivering pipeline. This buffer tank equalizes the pressure differences and is equipped with an automatic solenoid valve which opens the valve at a certain lower pressure and closes it at a fixed higher pressure. The analyser device which controls the mixed gas quality and blend rate is also connected to the buffer vessel.

### 5.3.8 Feeding the recovered gas for reuse

The mixed shielding gas is delivered through the circular pipeline system to the welding process. The circular pipeline is necessary to keep the pressure equalized throughout the pipeline. In big metal shops with numerous welding places and fluctuating gas consumption this is essential to ensure the accurate gas mixture at the correct flow rate from the very beginning of the welding work,

Figure 5.12.

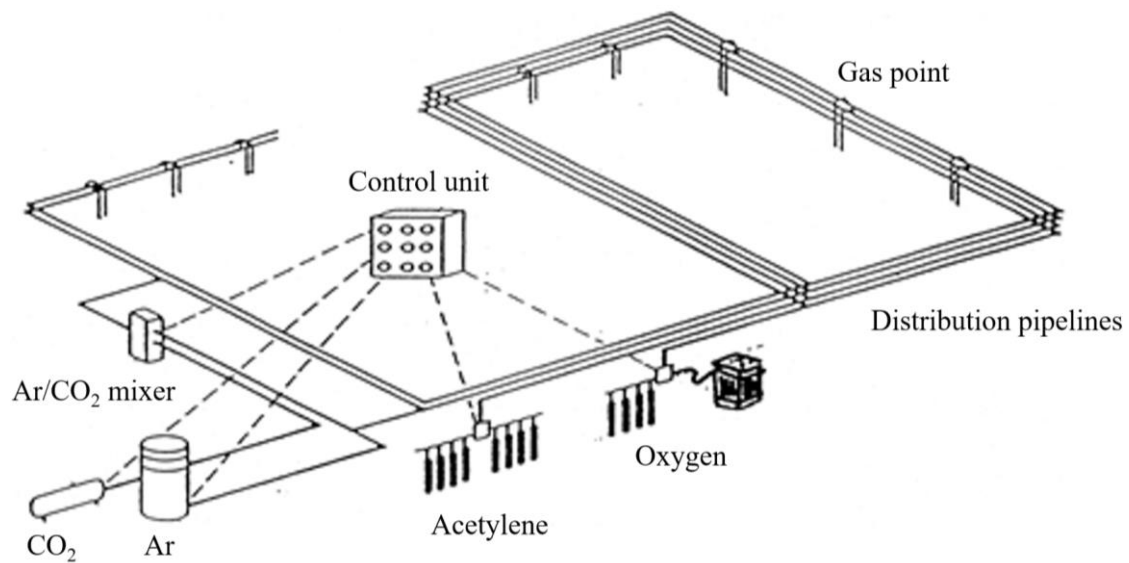

Figure 5.12: The circular gas delivery pipeline in the workshop.

Each of the rigid feeding pipes to the welding stations or places must be mounted to the top section of the main gas supply pipeline with a swan neck principle. The reason for this is to avoid possible loose particles in the main pipeline from flowing into the local pressure regulators and flow meters, causing blockages in the flexible hose feeding the shielding gas to the welding machine and its torch.

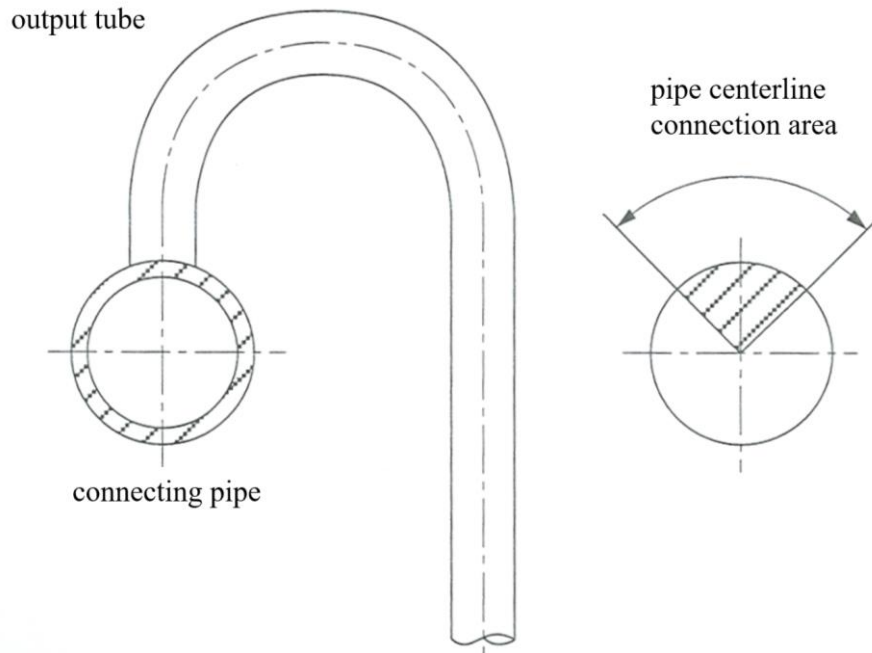

Figure 5.13: Feeding pipeline “swan neck principle.”

#### 5.4 The main results

The aspects examined in this thesis have given the following technical, economic and environmental results:

1. Technically the designed welding gas recovery model gives the opportunity to recycle the most valuable welding shielding gas components and encourages to find and use the best and most suitable shielding gas mixture to the welding process in question. The efficiency, effectivity and welding quality can be increased.
2. Economically the recovery model gives the opportunity to decrease the total welding, shielding gas and transportation costs and the investments to the welding process equipment.
3. Environmentally the recovery model gives the opportunity to reduce CO<sub>2</sub> emissions by lowering the transportation needs and gives the possibility to use such welding gas mixtures where oxone formation is reduced and the welding process is safer and healthier to the welder.



## 6 Suggestions for further study

This chapter suggests two possible directions for future research. First and foremost is to conduct experiments to confirm the proposed theoretical design of the helium recovery system during welding. The system principles and primary design considerations are described in Chapter 5. A practical approach is needed to confirm the effectiveness of the helium recovery and recycle system and to implement this system to the manufacturing industry. This system can offer significant benefits for industries that use helium as shielding gas or shielding gas mixture and the helium recovery can motivate to use more helium on different welding applications and with different materials.

The recovery system research for other shielding gases such as argon and CO<sub>2</sub> are an interesting opportunity to save the environment and costs in the future. Argon is used in large volumes in steel production all over the world and CO<sub>2</sub> emissions can be reduced by recovering and recycling CO<sub>2</sub> at its source of consumption and in different applications.

A second possible future research topic relates to using helium shielding welding for novel materials, such as AHSS, UHSS, novel grades of aluminium and titanium. More research is needed to develop welding processes with pure helium or multi-component shielding gas for welding demanding materials. As this work shows, using helium as a shielding gas can offer unique advantages in term of welding operation and quality.

## 7 Conclusions

The core of the thesis is the novel and unique helium shielding gas recovery and recycling system innovated and designed by the author. This system presents a special opportunity for increased helium use in shielding gas welding. Helium presents many advantages to the gas shielded welding processes but it is not universally used because of helium availability and its price. The new recovery and recycling system encourages increasing the use of helium and putting in place the most appropriate gas mixtures to suit the material under work and the welding process. The new helium recovery process offers remarkable economic savings and lowers environmental impacts by reducing CO<sub>2</sub> emissions, transporting costs, investment costs in transportation vessels, and gas purchasing costs. Recovering and recycling of materials are important actions now and in the future for humankind to survive on the globe. This thesis gives a greener approach and has undisputed research and novel value to gas arc welding and its shielding gas applications.

The thesis gives an overview of welding shielding gases and their use. Helium and argon are the most important shielding gases in welding. Helium comprises many positive properties advantageous to the welding process. The other shielding gases and their properties are also evaluated with different materials and welding processes.

The research objectives address the availability of helium, its sources and production plants (refineries), helium price structure, the recovery and recycling systems of helium in different processes and the novel recovery system in welding applications.

The thesis addresses the following research questions:

1) What is the required equipment and materials for helium recovery and recycling in welding applications?

The helium recovery system proposed in this thesis consists of fume extraction components, filters for particle removal, a compressing unit, dryer and molecular sieve units, a buffer tank, a mixer unit, and an analysing and gas feeding system. The proposed design allows efficient helium gas extraction and its reuse as a shielding gas for welding processes.

2) What are the welding applications where helium recovery provides positive results?

The developed helium extraction system focuses on GMAW but can also be used in other welding processes. In most GMAW processes the welding fume is mainly generated by the filler metal material and only a small part comes from the parent material. The particles appear in a cluster form. The helium recovery system is designed so that the contaminating particles and used shielding gas, air (N<sub>2</sub> and O<sub>2</sub>) and moisture can be separated, and the helium is recovered in a pure form. Automated laser and robot welding processes which use extensive volumes of shielding gases are the most suitable

applications for the recovery system. Laserhybrid, GTAW and PAW welding processes are also potential applications for the recovery and recycling system.

3) How can the helium recovered from different helium applications be utilized in welding applications?

Helium is recovered from different applications in gaseous form. The biggest helium users are MRI units in hospitals, research centres, universities, and MRI manufacturers. The recovered helium consists a certain amount (the lowest levels about 2%) of impurities such as air (nitrogen, oxygen) and moisture (H<sub>2</sub>O molecules). The recovered helium is compressed into high pressure cylinders and delivered to the purification system that can be installed in the welding workshop. After purification, the gas can be delivered to the shielding gas pipeline system and mixed to the appropriate blend for the welding process.

Helium is recovered from welding processes by collecting the fumes, purifying them from particles and impurities, and utilizing the valuable substances, especially helium and other shielding gases. The analysed recovery gas is blended into the shielding gas process flow through an automated mixing unit.

4) What advantages does helium recovery bring to the welding applications?

The greatest advantages of helium recovery are the reduction of welding costs and the improvement of the welding efficiency and quality. Application of helium or helium mixtures can increase efficiency, improve productivity, and offer other positive effects (work safety, weld beam features and quality) to the welding process. When helium is recovered and recycled it motivates using more helium in different welding processes and capitalising on the best features of the shielding in different welding processes. The direct and indirect welding costs can be reduced. Recovery and recycling also reduces the negative environmental impact and this motivates to consider and discover more materials and substances that can be recycled and reused. The recovery also leads to remarkable savings to helium transportation and transport equipment costs and annual gas purchasing costs.

5) What are the challenges of helium recovery in welding applications?

The biggest challenge is the recovery gas impurities, its quality and analysis. If the recovered gas purity varies and impurities are mixed with the pure gas components in the mixing unit, welding failures can occur, and result in extra cost and difficulties. This can be avoided by a well-designed recovery process and back-up system which reacts before the welding failures are created.

6) The appropriate shielding gas/gases delivery method offers efficiency and savings to the welding process.

The shielding gas delivery method in the workshop plays an important role in the welding efficiency and economy. The first thing to decide is the right gas mixture for the material

under work and welding process. Next is decided at which phase and in what type of storage vessel the gas is to be delivered. After that are designed the pressure regulating and mixing system, the proper pipeline system, and the gas feeding devices to the arc. A good predesign can minimise the direct and indirect costs of the shielding gas for the benefit of the workshop. The regular and documented service work of the gas delivery system and the welding equipment is an important part of an effective welding process.

The entire shielding gas delivery can be divided into small parts at every section. The right choices at every step bring the results that count. Effective helium and shielding gas recovery and recycling will be an important part of operations in a modern metal shop in the future.

7) What type of effects does the helium recovery and recycling system have on promoting a greener environment and lowering CO<sub>2</sub> emissions?

The recovery and recycling systems play a key role in the sustainable development of humanity. Just one use of valuable resources leads to, in the long run, an unsustainable situation. The techniques for recovering helium in welding applications have been developed to improve the welding processes and enhance their environmental friendliness. By using a helium recovery and recycling system the CO<sub>2</sub> emissions are decreased, energy and transportation costs are saved, productivity increased, and the CO<sub>2</sub> footprint reduced. Helium is a valuable and limited resource on earth which humanity needs to use wisely, applying all possible means to recover it from the main applications.



## References

- A. Traidia, F. R., 2011. A computational investigation of different helium supplying methods for the improvement of GTA welding. *Journal of Materials Processing Technology*, Volume 211, pp. 1553-1562.
- Air Products' Doe Canyon Helium Plant, 2016. *World's first facility to produce helium from carbon dioxide stream.* [Online]  
Available at: <http://www.airproducts.com/Microsites/doe-canyon.aspx>
- Aissa, A. et al., 2013. Ranz and Marshall correlations limits on heat flow between a sphere and its surrounding gas at high temperature. *Thermal Science*.
- American Welding Society, 2002. *Welding related expenditures, investments and productivity measurement in US manufacturing. construction and mining industries*, s.l.: s.n.
- Anon., 2019. *Helium Recovery Systems.* [Online]  
Available at: <https://www.linde-engineering.com/en/process-plants/cryogenic-plants/helium-recovery-system/index.html>
- BernardWelds, n.d. *The Causes of GMAW Flaws ... and the Cures to Help Welding Operators Get Back to Work Faster.* [Online]  
Available at: <https://www.bernardwelds.com/the-causes-of-gmaw-flaws--p152072>
- Blondeau, R., 2008. *Metallurgy and Mechanics of Welding - Processes and Industrial Applications*. London: Wiley.
- Blunt, J. & Balchin, N. C., 2002. *Health and Safety in Welding and Allied Processes*. 5 ed. Cambridge: Woodhead Publishing Limited.
- Boulos, M. I., Fauchais, P. L. & Pfender, E., 2015. *Transport Properties of Gases Under Plasma Conditions - Handbook of Thermal Plasmas*. s.l.:Springer.
- Cai, X., Fan, C., Lin, S. & Yang, C., 2017. *Influence of helium content in shielding gas on metal melting*. Shanghai, s.n.
- Cai, X. et al., 2020. Droplet transfer and weld formation of MIG welding with Ar-He alternating gas for aluminum alloy. *Journal of Manufacturing Processes*, Volume 49, pp. 94-101.
- Chrz, V., 2010. *Helium Recovery*, Geneva: CERN.
- Compressed Gas Association Inc. , 1999. *Handbook of compressed gases*. 4th ed. s.l.:Kluwer Academic Publishers.

- Cram, L. E., 1985. Statistical Evaluation of Radiative Power Losses From Thermal Plasmas Due to Spectral Lines. *Journal of Physics D: Applied Physics*, pp. 401-412.
- Czapigo-Czapla, M., 2012. *Helium*, s.l.: s.n.
- Danabalan, D., 2017. *Helium: Exploration Methodology for a Strategic Resource*, Durham: s.n.
- Davies, A. C., 1996. *The Science and Practice of Welding*. 10 ed. s.l.:s.n.
- Groover, M. P., 2010. *Fundamentals of Modern Manufacturing - Materials, processes and systems*. Betlehem: John Wiley & Sons, Inc..
- Haelsig, A., 2015. *Energy Balance of Welding Processes*, Germany: s.n.
- Helium One, 2020. *Helium One Project*. [Online] Available at: [http://www.helium-one.com/wp-content/uploads/2018/09/HeliumOne\\_CorpPres\\_Aug\\_18.pdf](http://www.helium-one.com/wp-content/uploads/2018/09/HeliumOne_CorpPres_Aug_18.pdf) [Accessed 12 04 2020].
- HSE, 2005. *EH40/2005 Workplace exposure limits*. s.l.:s.n.
- IHS Markit, 2019. *Chemical Economics Handbook*. s.l.:s.n.
- J.R. Campbell & Associates, Inc., 2013. *Determination of Fair Market Value Pricing of Crude Helium*, Lexington, Massachusetts: U.S. Department of Interior's Bureau of Land Management and Office of Minerals Evaluation.
- Jeffus, L., 2012. *Welding - Principles and Applications*. 7 ed. s.l.:Delmar Cengage Learning.
- Kanga, B. Y., Yarlaga, K. V. & Prasad, M. J., 2009. Characteristics of alternate supply of shielding gases in aluminum. *Journal of Materials Processing Technology*, p. 4716–4721.
- Kemper America, 2018. *Why is Welding Fume Extraction So Important?*. [Online] Available at: <https://kemperamerica.com/welding-fume-extraction-important/>
- Konishi, K. et al., 2016. Numerical analysis of arc phenomena during TIG welding with a constricted nozzle by using a two-temperature model. *IIW*, Issue IIW Doc.212-1433-16.
- Korjala, K., Mvola Belinga, E. & Kah, P., 2017. *Effectiveness and development of an optimum blend for welding high-performance steels*. San Francisco, International Offshore and Polar Engineering Conference (ISOPE).

- Laughton, M. A. & Warne, D. F., 2003. *Electrical Engineer's Reference Book*. 16 ed. s.l.:Newnes.
- Ley, F., Campbell, S., Galloway, A. & McPherson, N., 2015. Effect of shielding gas parameters on weld metal thermal properties in gas metal arc welding. *The International Journal of Advanced Manufacturing Technology*, pp. 1213-1221.
- Lukkari, J., 2006. The effects of shielding gases to the visual quality in MIG/MAG nickel steel welding. *Hitsaustekniikka*, June.p. 23.
- Lu, S., Fujii, H. & Nogi, K., 2009. Arc ignitability, bead protection and weld shape variations for He–Ar–O<sub>2</sub> shielded GTA welding on SUS304 stainless steel. *Journal of Materials Processing Technology*, 209(3), pp. 1231-1239.
- Lyttle, K. & Stapon, G. W. F., 2005. *Symplifying Shielding Gas Selection*, s.l.: The Welder.
- MadeHow, 2019. *How Helium is Made - Material, History, Used, Processing, Components, Product, Industry, Raw Materials*, s.l.: s.n.
- Miller, P., n.d. *New Gas Blends for Welding Aluminum*, s.l.: Praxair Inc..
- Mohr, S. & Ward, J., 2014. Helium Production and Possible Projection. *Minerals*, pp. 130-144.
- Mordor Intelligence, 2019. *Helium Market - Growth, Trends, and Forecast (2020-2025)*, s.l.: s.n.
- Murphy, A. B. & Lowke, J., 2018. *Heat Transfer in Arc Welding - Handbook of Thermal Science and Engineering*. s.l.:s.n.
- Nath, B. B., 2013. *The story of helium and the birth of astrophysics*. 1 ed. New York: Springer.
- National Minerals Information Center, 2020. *Mineral Commodity Summaries 2020*, Reston: U.S. Geological Survey.
- National Research Council, 2010. Refined Helium Supply Chain. In: *Selling the Nation's Helium Reserve*. s.l.:s.n., p. 156.
- Novikov, O. et al., 2012. Effect of changes in the composition of the gas shielding medium on the properties of arc welded joints in aluminium alloys. *Welding International*, 27(3), pp. 222-225.
- Pacheco, N. & Ali, S. F., 2008. *Helium Resources of the United States - 2007*. Denver(Colorado): Bureau of Land Management.

- Praxair Direct, 2019. *Welding Terms Glossary*. [Online] Available at: <https://www.praxairdirect.com/Industrial-Gas-and-Welding-Information-Center/Technical-Data/technical-terms-glossary.html>
- Ramsay, W. & Soddy, F., 1903. Experiments in Radioactivity of the Production of Helium from Radium.
- Rand, C. D., Fieret, J. D. & Viyyuri, S., 2009. *Laser welding with reduced helium consumption*. [Online] Available at: <http://google.com/patents/ep2283962a1?cl=en> [Accessed 12 2019].
- Sarma, D., 2014. *Optimising Automotive Components Production using shielding gases: practical recommendations for modern day*. Seoul, s.n.
- Saudi, N., 2017. *Helium production in the world*, s.l.: Interactive, Science & Technology.
- The Editors of Encyclopaedia Britannica, 2020. *Helium Chemical Element*, s.l.: s.n.
- The Linde Group, n.d. *Shielding Gases. The right gas working for you.*, Pullach: s.n.
- Timings, R., 2008. *Fabrication and Welding Engineering*. s.l.:Newsnes.
- Tusek, J., 1996. *Influence of a Shielding Medium on Arc Energy Efficiency*, Ljubjana: IIW.
- TWI Global, 2019. *What is meant by wetting and how can it be used?*. [Online] Available at: <https://www.twi-global.com/technical-knowledge/faqs/faq-what-is-meant-by-wetting-and-how-can-it-be-used>
- US Department of Labor, 2017. *Occupational Safety and Health Standards*. s.l.:s.n.
- Weman, K., 2012. *Welding Processes Handbook*. 2 ed. s.l.:Woodhead Publishing.
- Willams, J., 2019. *Space exploration*. [Online] Available at: <https://space.stackexchange.com/questions/21246/why-does-the-falcon-9-require-a-helium-pressurization-system> [Accessed 12 01 2021].
- Wilson, A. R., 2019. *Market Study on the Global Helium Market*. New York, Natural Resources Market Research Specialists & Consultants.