



**LAPPEENRANTA UNIVERSITY OF TECHNOLOGY**  
**Department of Mechanical Engineering**  
**Section of Production Engineering**

## **A support system for evaluating a suitable joining method in the production of sheet metal goods**

The subject of Master's thesis was approved by the department council of Mechanical Engineering on 2<sup>nd</sup> March 2005.

Supervisor: Professor. Juha Varis

Instructor: Dr. Mikael Ollikainen

Lappeenranta, April 07, 2005

**Mohammed Sajid Ali**

**0266445**

**DMWT**

**LUT, FINLAND**

## ABSTRACT

<b>Author:</b> Mohammed Sajid Ali	
Topic of the Master Thesis: <b>A support system for evaluating a suitable joining method in the production of sheet metal goods.</b>	
<b>Department:</b> Mechanical Engineering	
<b>Year:</b> 2004-2005	<b>Place:</b> Lappeenranta, Finland.
Master Thesis: 79 Pages, 22 Figures, 7 Tables, 4 Charts and 3 Appendices. Supervisors: Professor. Juha Varis Dr. Mikael Ollikainen	
<b>Key words:</b> Sheet Metal, Joining Methods, Clinching, Welding, Mechanical Joining, Riveting, Fastening, Adhesive Bonding, Hybrid Joining, Self-Clip.	
<p>This report illustrates a comparative study of various joining methods involved in sheet metal production. In this report it shows the selection of joining methods, which includes comparing the advantages and disadvantages of a method over the other ones and choosing the best method for joining. On the basis of various joining process from references, a table is generated containing set of criterion that helps in evaluation of various sheet metal joining processes and in selecting the most suitable process for a particular product. Three products are selected and a comprehensive study of the joining methods is analyzed with the help of various parameters. The table thus is the main part of the analysis process of this study and can be advanced with the beneficial results. It helps in a better and easy</p>	

understanding and comparing the various methods, which provides the foundation of this study and analysis. The suitability of the joining method for various types of cases of different sheet metal products can be tested with the help of this table. The sections of the created table display the requirements of manufacturing. The important factor has been considered and given focus in the table, as how the usage of these parameters is important in percentages according to particular or individual case. The analysis of the methods can be extended or altered by changing the parameters according to the constraint. The use of this table is demonstrated by pertaining the cases from sheet metal production.

## **ACKNOWLEDGMENT**

This master's thesis work has been performed at the section of Production Engineering, Department of Mechanical Engineering, Lappeenranta University of Technology from October 2004 to March 2005. The facilities provided for the thesis work have been satisfactory, also the technical guidance, supervision and motivation provided has been overwhelming.

I owe my cordial and sincere gratitude to Prof. Juha Varis. He has really been very generous, helpful and encouraging. I would also like to pay my thanks to Dr (Tech.) Mikael Ollikainen for his fruitful criticisms and valuable advises, for the accomplishment of this work. Dr (Tech.) Antti Salminen also deserves my heartily gratitude for his valuable suggestions. I am also grateful to officials of the mechanical department for their co-operation with me. I am indebted by gratefulness to Ms. Riitta Ruokonen as well, for her affectionately sociable behaviour through out my studies.

I really feel short of words in paying my gratefulness to my family members who have always supported in every possible way. They enlightened the importance of getting authenticity into my mind and always encouraged morally. I am thankful to them for their financial help. My friends truly deserve my best regards. I am heartily thankful for their appreciation, co-operation and gratifying suggestions. They have been very kind, inspiring and encouraging throughout my studies.

Lappeenranta, April 07, 2005

**MOHAMMED SAJID ALI**

## TABLE OF CONTENTS

<b>ABSTRACT .....</b>	<b>I</b>
<b>ACKNOWLEDGMENT .....</b>	<b>III</b>
<b>TABLE OF CONTENTS .....</b>	<b>IV</b>
<b>1 INTRODUCTION .....</b>	<b>1</b>
1.1 Objective of the Study .....	2
1.2 Limits of the Work.....	3
1.3 A New Product.....	5
1.4 Cost Factors .....	6
1.5 Operating a Forecasting System.....	7
1.6 Important Factors in Custom .....	9
1.7 Design For Manufacturability and Assembly.....	10
<b>2 STATE OF THE ART .....</b>	<b>14</b>
2.1 Clinching.....	15
2.2 Blind Riveting.....	16
2.3 Self-Pierce Riveting.....	23
2.4 Screw Fastening.....	25
2.5 Laser Welding.....	27
2.6 Projection Welding .....	30
2.7 Adhesive Bonding .....	32
2.8 Hybrid Joining.....	37

2.9	Self Clip .....	38
<b>3</b>	<b>CONCEPTION OF THE TABLE .....</b>	<b>40</b>
3.1	Experimental Set-Up .....	41
3.2	Description of Parameters .....	43
<b>4</b>	<b>RESULTS .....</b>	<b>52</b>
4.1	Case 1, Washing Machine .....	53
4.2	Case 2, Light Fixture .....	56
4.3	Case 3, Cupboard .....	59
<b>5</b>	<b>ANALYSIS AND DISCUSSION .....</b>	<b>61</b>
5.1	Sensitive Analysis .....	62
5.2	Cost Analysis .....	66
5.3	Analysis for DFMA .....	71
5.4	Capacity .....	71
5.5	Appearance .....	72
<b>6</b>	<b>CONCLUSION .....</b>	<b>73</b>
	<b>REFERENCES .....</b>	<b>75</b>
	<b>APPENDICES A, B &amp; C</b>	

## 1 INTRODUCTION

Sheet metal joining methods have shown many advantages in numerous applications. The advantages are mainly based on different joining methods, which give precise products with the help of different joining processes. Joining methods are usually implemented for different types of metals and different types of products. In this study some joining methods are used for aluminium, stainless steel and pre-coated mild steel. The joining material can be of different composition from the parent material, or it may be a similar type of material employed in diverse conditions [1].

The selection of joining process is therefore a compromise in which due note is taken of the intended use and service conditions of the joint. It is rare that these considerations are the only criterion of selecting the joining method; it is also necessary to take into account the essential skills and associated expenses. The study of joining is important from both fundamental and applied science point of view; joining encompasses a wide range of areas with different processes, as is evident from the fact that researchers in different countries are principally working on the different types of joining methods [1].

It must constantly be obligatory to look that the demand remains constant, and in case demand is unsteady, determination of the production levels can be complicated, if the production plan is taken as ideal, the constant production rate can be satisfied with constant capacity. The process must be constructive, creative and may also need to be innovative, nevertheless, every idea that is presented must be examined upto a considerable depth, before any reasonable assessment can be a successful conclusion [2].

In the present work, major focus has been given towards the joining methods applicable in sheet metal production and how efficiently the different joining methods

can be utilized in the sheet metal production. Sheet metal production has numerous applications and the production depends completely on the joining methods. For technical reasons, the selection of a manufacturing method is frequently not an entirely free choice; the reasons for preferring a process to other should ideally be based on considerations that are entirely technical and economical.

### **1.1 Objective of the Study**

The foremost objective of the study exemplifies a comparative study of various joining techniques involved in sheet metal industry. The major purpose of this exertion is to look out for the most appropriate and convenient joining method in sheet metal production; not only for the reason of joining but the progress should persuade all the other provisions like cost factors, materials, strength properties, etc. The elements of the activity that meet the purpose and scope are to formulate the useful methods for the selected solution.

The study incorporated is aimed at choosing the best possible joining methods for the production of sheet metal products, taking into consideration of provisions and parameters. All the parameters are accordingly required to meet the production methods that are selected carefully by comparing the benefits and disadvantages of all the joining methods for assorted products. Apart from this, few other factors have to be considered like the appearance of the joint, quality of the joint, usage of the product and its affecting factors.

In some cases, the joining method used for a product will have perfect or nearly perfect conditions, which are satisfied due to studies and research previously done. It may be difficult to find a better choice for selection of joining methods over the existing methods in such cases. This study focuses on analyzing all the methods of joining for each product considered and choosing the best method irrespective of



what presently exists in production and continuously trying to improvise if there is a possibility [1].

## **1.2 Limits of the Work**

In the present work, three products have been selected and a detailed study of the joining methods is analysed with the help of various parameters such as material and its possibility of joining, reproducibility, joint tightness, load resistance, corrosion, environment friendliness, investment, etc. The development of the new product goes through a series of major phases that begins with ideas and culminates in finished product or system; the development of the product requires the technical and supporting functions. Although the manufacturing process is most often thought to be the framework of new product development, there may be changes in existing products. Some changes can be made to take an advantage of new product or to improve service performance and high reliability [4].

In engineering applications, service conditions may produce variation in material properties, which could lead to inappropriate functioning of the entire coordination or product. These alterations may be caused by upbringing, temperature or radiation from the surroundings. To overcome the different effects, it must be accountable for the mechanical and physical functions [4].

There are varied kinds of sheet metal products, but this work is oriented only for a limited type of products. Although these case products can employ different types of sheet metals, but for the analysis of manufacturing methods a particular material type based on pre-coated materials is taken; this offers a limitation on the material type that may deviate for other studies and the selection of a particular material type consequently puts a limitation on manufacturing method as well. Some of the possible joining techniques for several sheet metal products are thus automatically eradicated. In some of the welding process for example MIG/MAG or TIG welding

processes that are unsuitable for pre-coated materials, hence are not considered as a possible joining means in present work [1].

In the analysis of the manufacturing methods a general approach is adopted for a more detailed and other alternative process. The variation of some of the possible manufacturing methods is treated as proverbial and a broad idea of the production method is pursued. The illustration of laser technology for possible joining technique is presented with CO<sub>2</sub> lasers only, although other laser processes such as Nd: YAG can also be employed. This mode of selection of CO<sub>2</sub> laser welding doesn't make substantial influence on the possibility of joining process, as the other laser processes can also be employed with variation of several parameters [1].

The investment of the manufacturing systems sometimes plays an important role in the cost of the process, the cost factor of the case product is analysed from the process cost point of view. This cost factor is not considered because the objective is to decide the production method for these case products by considering the technical feasibility irrespective of the cost. Hence deep insight into the manufacturing aptitude of these pre-coated sheet metal products is taken while giving less weightage to the investment aspect.

Therefore a clear view of the functioning of the product and its application in real world must be taken into account while selecting the joining method. A forecasting in terms of the usage and the present requirements for the product together helps to make the right choice for selection. One other major factor, which has to be considered, is the cost effectiveness compared to existing products and methods. The comparative analysis of the various joining methods and the detailed evaluation of the selection process and product on the whole with respect to the functioning and cost may lead for the optimum choice for selection of the joining method for a product.

### 1.3 A New Product

The creation of a new product should commence with a clearly defined objective, derived from market research in the case of a component for sale and associated cost accountancy and with a time scale which should allow an optimum choice to be made. It is a fact that material selection should be an integral part of the design process and it is necessary to examine the nature of the design process. It has been suggested that any design can be characterized in terms of four principal attributes

- function of the product
- appearance of the product
- required manufacturing method, and
- total manufacturing cost.

Material selection should contribute to every part of design and manufacturing process and its contribution mainly involves in the decision making part of the design and manufacturing, and it must always be pre-dominant as shown in figure1 [4].

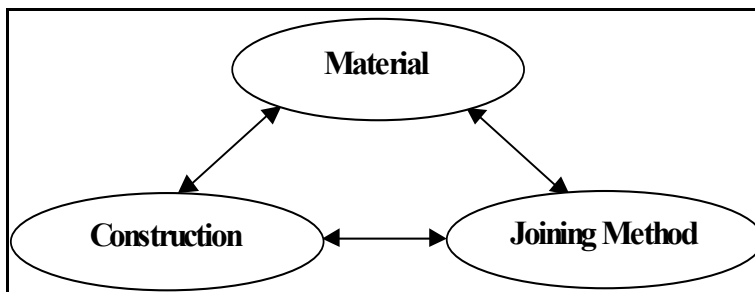


Figure 1 Manufacturing Requirements [1]

The properties of a given design and material may be regarded according to the extent to which they are cost-effective. The total cost of the manufactured article in service is made up to several parts as shown in figure 2.

The manufacturing and production field may concern itself with a whole enterprise, with a major sector or system. It requires proceeding with a need, frequently vague and nebulous, and proceeds through an identifiable process to plan the optimum use of resources to meet the need. Final production will be decided among available alternatives, judging on the basis of accepted criteria, iterating until a satisfactory solution is reached [3] [4].

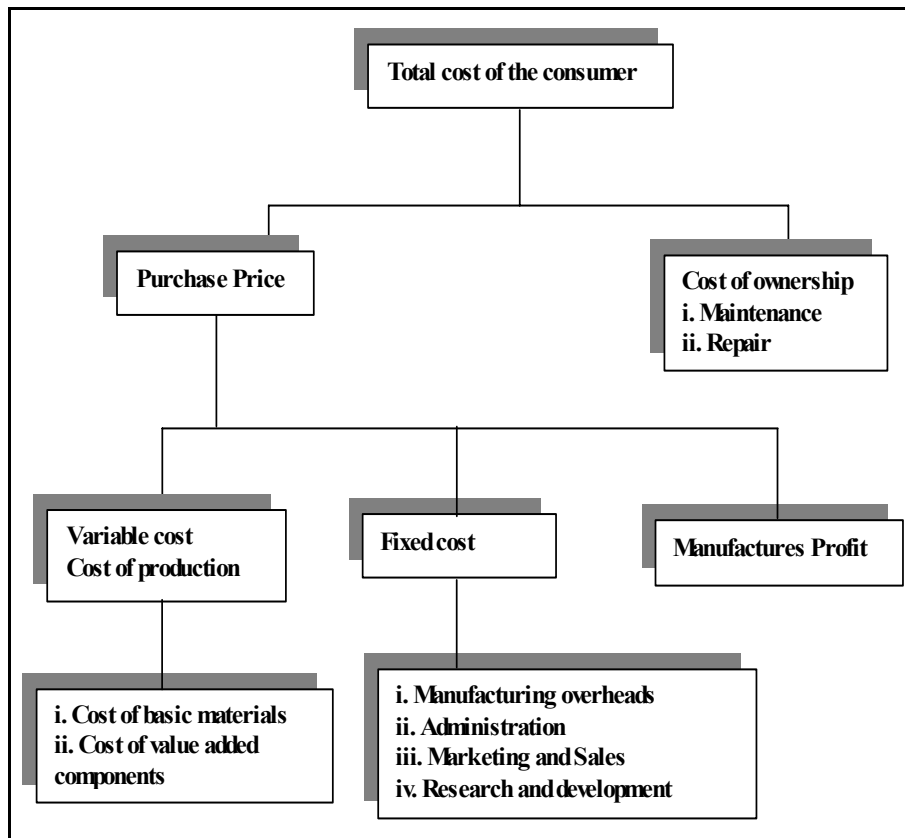


Figure 2 Cost Efficiency [4]

#### 1.4 Cost Factors

Design Engineers, Manufacturing Engineers and Industrial Engineers in analyzing alternative methods for producing a part or a product or for performing an individual operation or an entire process, are faced with cost variables that relate to materials, direct labor, indirect labor, special tooling, perishable tools and supplies, utilities, and

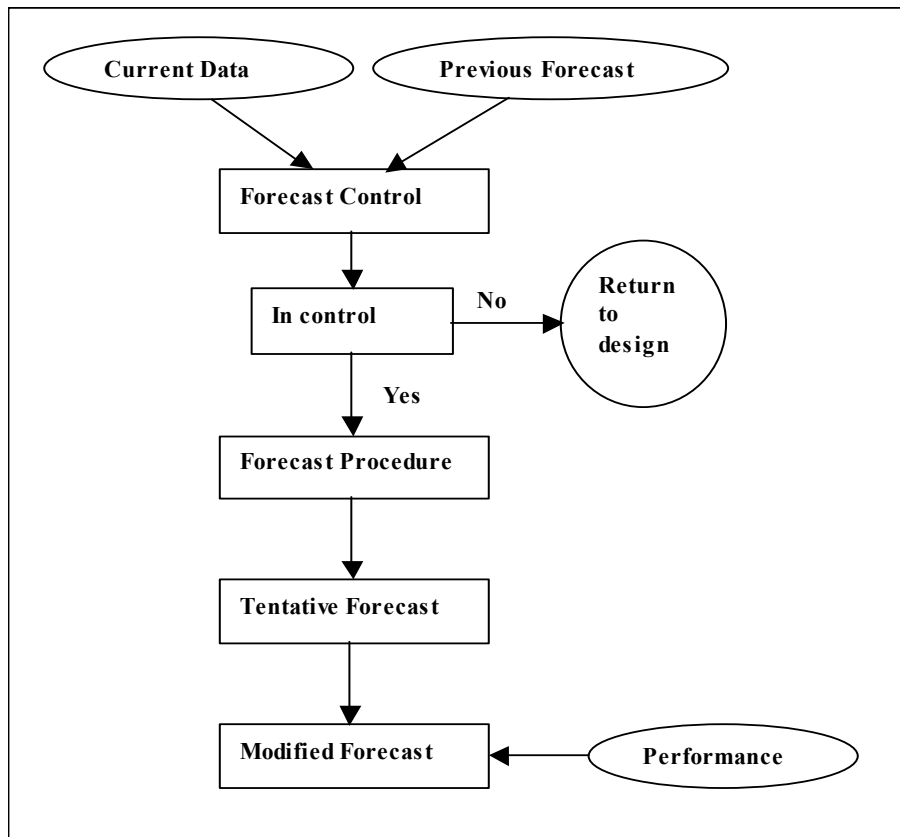
invested capital. The inter-relationship of these variables can be considerable, and therefore a comparison of alternatives must be detailed and complete to assess properly their full impact on total unit cost [3].

The unit cost of material is an important factor when the method is compared involves the use of different amounts or different forms of several materials. It will be easier and less risk for a company to embark on a program or a new product that utilizes an extension of existing facilities.

### **1.5 Operating a Forecasting System**

Interpreting the solution is the major task of operating the forecasting system. Figure 3 shows the various steps involved in the flow of forecasting. If the quality is acceptable, it is said that the procedure is in control and if the quality is not acceptable then the procedure is said to be out of control and it needs to return to the design phase. It needs either to re-estimate the parameters of the current model or change the model itself. If the forecasting system is in control, forecast for a future period can be assumed [3].

The purpose of this system is what the article has to do when it is in service. This part of the process sometimes can be intricate because it must be constructive and creative and may also need to be innovative. Nevertheless, every idea that is presented must be examined in considerable depth before any reasoned assessment, which can be a successful conclusion [3].



**Figure 3 Operation of Forecasting System [3]**

It always required looking for the demand to be constant, and when demand is not constant, determining production levels is more complicated. If we keep the production plan to be ideal, the constant production rate can be satisfied with constant capacity. When demand varies, the desired production levels are not obvious. We must determine a 'Production Plan'. The goal is to match the production rate and the demand rate. As in forecasting, production is planned over several different time horizons through hierarchical approach. Typically three plans over different time horizons are developed sequentially. These are long-range plans, intermediate-range plans and short-range plans. There are three aspects of aggregating planning that are most important are capacity, aggregate units, and costs [3].

## 1.6 Important Factors in Custom

Joining is certainly one area of appliance assembly that requires manufacturers to carefully weigh solution benefits and drawbacks. Options range from clinching, self-pierce riveting, blind riveting, laser welding, projection welding, adhesive bonding, hybrid joining and self-clip. The best applicable technology is determined by the demands on quality of the final product, available production time and the investment budget. There's a strong interaction between these three factors as shown in figure 4.

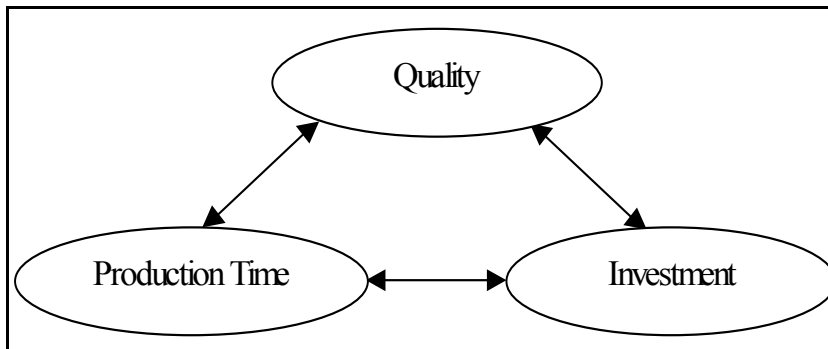


Figure 4 Important factors for Joining [4]

Naturally, manufacturing/assembly considerations also have to be taken into account. According to TWI world centre for materials joining technology the choice for the optimal joining technology also depends on:

- The ease of automation.
- The materials to join and the thickness of parts being joined.
- The construction and the accessibility to the joint.
- The dimensions and the tolerances of the joints.
- The joint length.

## 1.7 Design For Manufacturability and Assembly

Design for Manufacture and Assembly, DFMA, allow you to systematically analyse your product designs with the goal of reducing manufacture and assembly costs, improving quality and speeding time to market. Machining and tolerances are areas where the use of DFMA and Rapid Prototyping (RP) are of particular benefit, specifically; the design for manufacture aspect can help manufacturers select tool materials, types and dimensions of cuts, and a surface finish [5].

The designing in sheet metal has no difference than the designing components from other semi-finished products such as solid stock, metal profiles, or parts that have been cast or forged. Only by considering the characteristics of sheet metal and the advantages afford by modern sheet metal processing in the design process, is it possible to achieve the intend goal; a functional, economically manufactured component. There are no universally valid assessment criteria that can be used to determine what kind of material a component should ideally be made of, in the most efficient way [7].

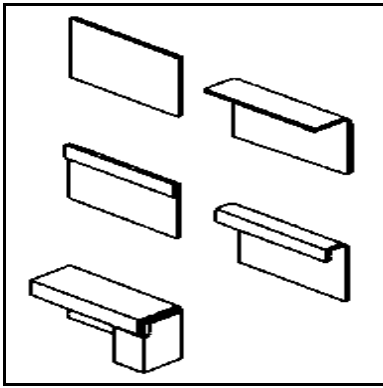
The large selection of the materials available is not exhausted for work pieces made of sheet metal, because the demands on these pieces are normally not all that varied. Whereas strength and hardness are the most important selection criteria for machine parts, it is the working properties and non-corrosive characteristics that are of primary importance for sheet metals. In many cases the material selected is less for its load resistance than for its suitability for a particular process. Suitability for punching, flame cutting, laser cutting as well as deformability for deep drawing, bending and welding are all factors to be considered.

During the development stages of a new product, cost and cost drivers certainly deserve careful consideration. However they tend to be neglected, especially when designers lack a reliable method of managing and understanding them. If the goal is



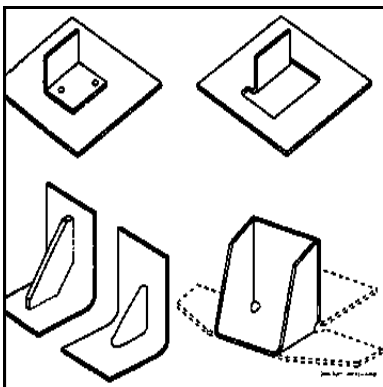
to improve a product without increasing costs, the lack of cost detail during design can really hold back. Design teams often find relying on past manufacturing and assembly costs recorded for previous or similar versions of a product. Usually, designers have no way of accurately quantifying whether the specific innovation they are contemplating will increase or reduce overall product cost [6].

The requisite of the rigidity can be attained, by forming the edges of the sheet metal, by folding the edges once or several times, load-supporting components can be created as shown in figure 5.



**Figure 5 Design of Sheet edges to increase rigidity [7]**

In many cases, material costs and production costs can be reduced if the parts are formed from one semi-finished sheet metal part instead of constructing them from many joined semi-finished sheet metal parts as shown in figure 6.

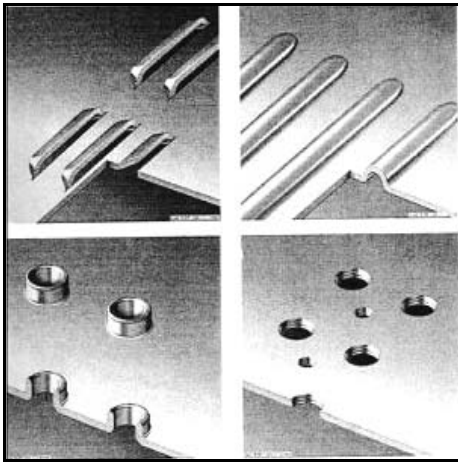


**Figure 6 Forming instead of joining and welding [7]**

As a supplement to punching and nibbling, a variety of formed areas with limited height can be created in the sheet using special tools. The most important formed areas are louver cuts, beads, extrusions and thread forms as shown in figure 7.

Special tools can be used in:

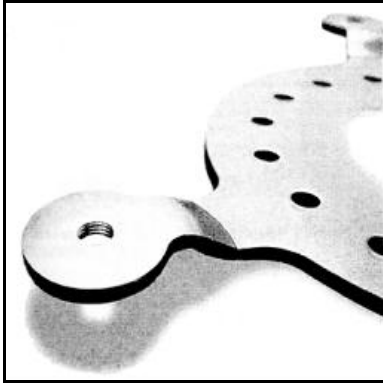
- Marking operations
- Counter sinking
- Counter boring
- Multi-hole punching [7].



**Figure 7 Forming created using special tools [7]**

Multi-process manufacturing machines, which are called as combination machines, are developed for parts that can derive advantage from combining multiple manufacturing processes, for example, punching, laser cutting and forming. Standard geometrical forms are punched and formed areas are formed whereas freely shaped and filigree counters are cut with the laser.

Combination machines combine many technologies; from punching and forming to laser cutting. Hence, every contour can be manufactured with the most appropriate technology. The work piece can be completely processes in one clamping, resulting in high precision and productivity [7].



**Figure 8 Multi functions done in single unit [7]**

Sheet metal component fabrication is rapidly developing branch, in which new manufacturing technologies, machine tools and tool technology will provide new possibilities for fabricating functional components more economically. Utilizing DFMA knowledge in sheet metal component fabricating, together with least information on new manufacturing possibilities, will offer possibilities for large improvements compared with the status of sheet metal component fabricating.

## 2 STATE OF THE ART

The important factors in selecting joining process are usually the design of the joint and the thickness of the material. The basis of selection scheme is therefore a descriptive list of joining methods, which together with their accompanying processes cover the required types of applications, which can be used for the sheet metal production. The selection includes comparing the advantages and disadvantages of a method over the other ones and choosing the best method for joining.

The table thus generated for the purpose of selection of the joining process helps us to understand, compare, analyze and evaluate the various joining methods with respect to the requirements mentioned. The purpose of putting effort in forming the table is mainly because of its various advantages involved. It helps the reader to easily understand the various concepts involved for selecting the optimum method for the joining process.

The table may be used for comparing and selecting the joining method not only for the experimental products chosen but also for many other different products. The reader gets a clear idea and understanding of the detailed comparison and analysis involved in selection. This table requires to be improvised taking into account the functionality and the cost involved of the product with respect to the existing product.

In the experimental table (see table 1), nine joining methods and the required parameters are deliberated. The comparative grading given for each parameter towards the method is on the basis of available information and data about the methods.

## 2.1 Clinching

Clinching is a high speed fastening technique, which uses a special punch & die to form a mechanical interlock between the sheet metals being joined. Clinching is a fairly new technology; used mainly for high-volume, low specification applications. It is used for joining metal sheets of 0.5 to about 3 mm in thickness, up to a total joint thickness of about 6 mm as shown in figures 9 and 10. As the joint is made by local plastic deformation of the sheets, the materials should have sufficient ductility to avoid cracking. Clinching can be used on coated and painted materials, and is suitable for joining dissimilar materials [8].

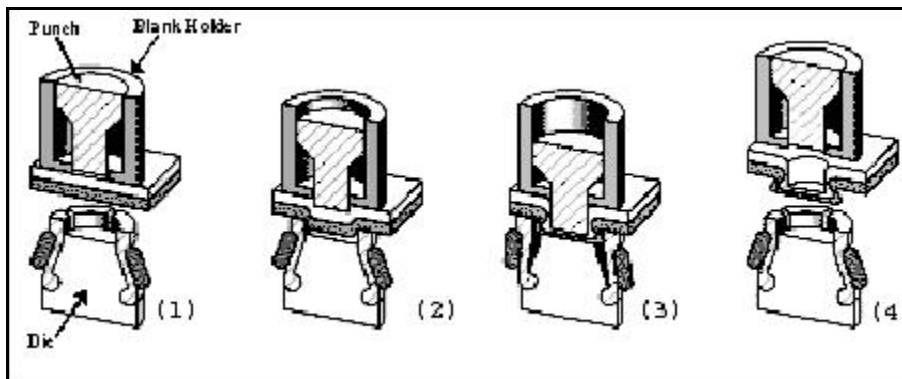


Figure 9 Clinching Technique [8]

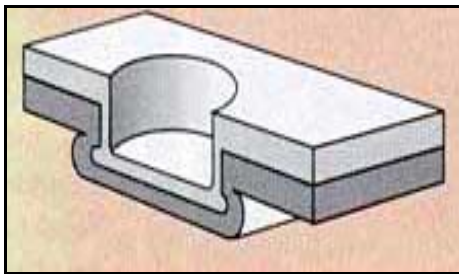


Figure 10 Clinching Technique [9]

Typical materials that can be clinched include:

- Low carbon and micro-alloyed steels.

- Zinc-coated, organic coated and pre-painted steels.
- Stainless steels.
- Lightweight materials, such as ductile aluminium alloys [8].

Clinching is mainly used for joining steel sheet for white goods, heating and ventilating and automotive part manufacture. There, it replaces techniques such as resistance spot welding as well as the use of other mechanical fasteners, such as riveting [10].

### **Benefits**

According to TWI world centre for materials joining technology [8] the benefits of clinching include:

- Low cost, because of low energy, single step process using no consumable.
- Possibility of making so called hybrid joints using adhesives and clinch joints together further increasing joint stiffness, and allowing a leak-proof joint to be made.
- Visual assessment of the joint is possible by checking the button dimensions and quality (in addition, in-process monitoring of force versus displacement can be used as a quality control measure).

## **2.2 Blind Riveting**

Blind rivets are permanently installed fasteners that sometimes exceed the performance criteria for comparable solid rivets. Unlike solid rivets, blind rivets can be inserted and fully installed in a joint from only one side of a part or structure, "blind" to the opposite side. The back, or blind side, is mechanically expanded to form a bulb or upset head. Because blind rivets are installed from only one side of the component, they are cost-efficient and versatile [11].

The blind rivet was originally developed as a replacement fastener for solid rivets where service repair was required. Blind rivets also trace their roots to the aircraft industry. Before blind rivets were widely accepted, installation of solid aluminum rivets in fuselages, wings and other airframe components typically required two assemblers: one person with a rivet hammer on one side of the structure and a second person with a bucking bar on the other side. Since rivets were often inaccessible from both sides of the work, this assembly process was extremely slow and very time consuming.

Today, blind rivets offer numerous benefits to assemblers, such as speed of installation, versatility, simplicity and cost. Unlike many other fasteners, blind rivets cannot be under-torqued, over-torqued or set loose. The unique design and function of blind rivets prevents these errors. A blind rivet is a two-piece fastener that consists of a headed, hollow rivet body and a solid mandrel. The body, or sleeve, looks like a small tube that is flared on one end. The tube portion is called the shank and the flared portion is called the head. The rivet body is usually round. The diameter of the rivet body determines the rivet size. A hole, or core, usually extends the length of the body. However, the extent of the core depends on the rivet style.

The mandrel is the mating section of the rivet body, also known as the stem, which protrudes from the rivet core. It looks like a nail or wire, and is pulled through the joint of a blind rivet hole during setting. The rivet body is inserted in a hole in the parts to be joined. Next, the jaws or nosepiece of a manual or automated rivet tool grips the mandrel. As the tool begins to pull the mandrel head into the rivet body, the body expands and forms a joint. Pulling on the mandrel with a rivet tool deforms the tail end of the rivet body, forming a blind-side head. At a predetermined setting force or tensile load, the mandrel breaks and falls away. The blind head is the rivet body portion on the blind side after the rivet has been set.

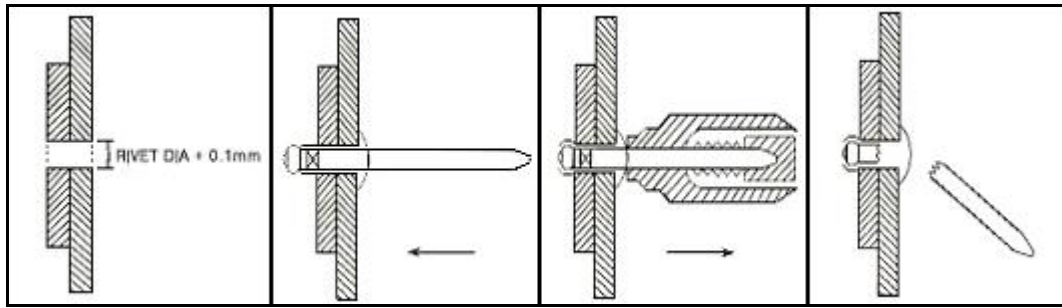
Unlike many other fasteners that require access to both sides, a blind rivet can be set from one side of the work. The ability to set blind rivets without the need for access

at the back of the workpiece makes their use mandatory in many instances. Blind rivets are commonly associated with the aircraft industry. However, they are also used in a wide variety of products, such as air bag assemblies, telecommunication equipment cabinets, stoves, air conditioners, garage doors, prefabricated metal buildings and mail boxes. Bus, truck, railcar and recreational vehicle assemblers are heavy users of blind rivets. Electronics manufacturers are also using more blind rivets for box-build applications.

Blind rivets are available in a wide variety of materials, diameters, and grip ranges and head styles. Material choices include aluminum, steel, stainless steel, copper, brass and plastic. Blind rivets are commonly classified as either pull-type or drive-pin-type fasteners. Pull mandrel or pull-up rivets have a hollow core rivet body and an integral mandrel. The mating mandrel is positioned in the rivet body, which includes a preformed head with the mandrel extending above the rivet head.

The mandrel end that protrudes from the rivet end flares out to a larger diameter than the diameter of the rivet body core. When the mandrel is pulled up after the rivet is inserted, it forces the rivet material out against the back of the assembly. This clamps the parts between the rivet head and the new-formed head on the blind side. The pull-type blind rivet is available in two basic configurations: self-plugging and pull-through. In the self-plugging design, a portion of the mandrel is permanently retained in the rivet body, contributing additional shear-strength properties to the installed fastener. The self-plugging blind rivet is typically used for structural applications where higher fastener shear strength is necessary because of joint design loadings [11].

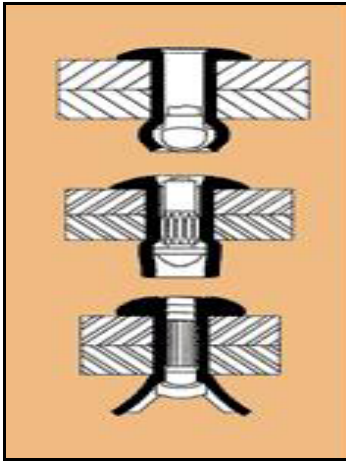




**Figure 11 Blind Riveting Process [12]**

In the pull-through blind rivet, the mandrel is completely drawn through the rivet body after expanding the rivet. It is typically used for lightly loaded or non-structural joining applications. A break-mandrel rivet is the most common type of pull-mandrel blind rivet. During the setting operation, the mandrel is pulled into or against the rivet body and breaks, causing a popping sound. Break mandrel rivets are available in two styles: semi filled core and filled core. Semi filled core rivets, also called non-structural, break the mandrel near the blind-side head, leaving a short length of mandrel in the rivet body and the core partially filled. Filled cores, or structural rivets, have a mandrel that fills the entire core and usually breaks near flush with the surface.

A drive-pin blind rivet includes a partial hole in the rivet body and a mating, protruding pin that is positioned in the hole. In the setting operation, the rivet is inserted into the components to be joined. The pin is hammer driven into the rivet body until the pin is flush with the top of the rivet head. Common styles of blind rivets include N-, Q- and T-types. The N, or nail rivet, features a break mandrel and semi filled core. It is often used to tack light sheets together where minimal stresses are exerted.



**Figure 12 Blind fasteners come in many shapes and sizes, including N-, Q- and T-type rivets [11]**

The Q-type rivet features a break mandrel and filled core. It's similar to the N-type rivet, except that the mandrel neck is knurled to lock the mandrel in the rivet body and assist in creating a seal. The mandrel breaks relatively flush with the rivet head in midgrip, increasing shear strength. The Q-type rivet is used in applications that require shear strength greater than that provided by an N rivet. The T-type, or peel, rivet features a break mandrel and filled core. During installation, knife action between the mandrel head and rivet shank splits the rivet into three "petals" that draw the sheets together. A T rivet mandrel breaks nearly flush with the rivet head in maximum grip. Because it's insensitive to hole size, the T-type rivet works in oversized or elliptical holes.

Many variations of blind rivets are available, such as the one-piece nut rivet that features internal threads as shown in figure. It provides load-bearing female threads for attaching removable parts in material that may be too thin to accommodate a thread. Other types of blind fasteners include locking and drive rivets. Locking rivets are vibration resistant and are less prone to failure in high shear loads. Drive rivets can be used in through-hole applications to fasten metal sheets, or in blind-hole applications to fasten wood and other low-density materials [12].



**Figure 13 Nut Rivets [13]**

### **Selection Criteria**

According to assembly magazine, factors such as joint strength, joint thickness, materials, hole size and head style must be considered before selecting a blind rivet. The single-joint tensile and shear values required for the application must be determined. These are functions of total joint strength, fastener spacing, rivet body material and rivet diameters. The total thickness of the materials to be joined must also be determined. This reveals the required grip of the rivet to select. Insufficient rivet length will not allow correct formation of the secondary head at the back of the work.

Both the rivet and the materials to be fastened will affect the ultimate joint strength. As a general rule, the rivet materials should have the same physical and mechanical properties as the materials to be fastened. A marked dissimilarity may cause joint failure due either to material fatigue or galvanic corrosion. Strength and durability are very important considerations when choosing blind rivets. For the blind rivet system to work, the pull mandrel or drive pin must be stronger than the rivet body, which must be relatively ductile to permit blind end expansion without cracking.

Blind rivet strength varies depending on the materials used and the specific type or design of fastener. If the joint needs to be very strong, a steel rivet works best. On the

other hand, plastic rivets may not be the best choice for an application, because they tend to dry out and get brittle. Hole size is very important in blind riveting. An undersized hole will make rivet insertion difficult or impossible. Too large a hole will reduce the shear and tensile strengths, and may cause incorrect rivet setting. It may also cause bulging or separation of the members by allowing the rivet to expand between them instead of on the blind side. It is important to avoid burrs in and around the hole.

Three different head styles are available for blind rivets: dome, large flange and countersunk. Dome head rivets, also called button heads, are the most versatile and most commonly specified head style. This type of fastener features a low profile and a neat appearance. The dome head has twice the diameter of the rivet body, providing enough bearing surface to retain all but extremely soft or brittle materials. Large flange rivets have twice the under-head bearing surfaces of dome head rivets. They are typically used for applications where soft or brittle materials must be joined to a rigid backing material. Countersunk rivets should be specified whenever a flush surface is required.

### **Problem Solving Tips**

According to assembly magazine a common problem that occurs when using blind rivets is mandrel pull through. When this happens, it leaves a burr outside of the eyelet flange. This problem can be resolved by drilling or punching the correct specified hole size for the rivet. When the recommended hole size is exceeded, the mandrel head of the rivet can drag its way through the rivet body. Another cause of rivet pull through is using a rivet below the minimum grip range. A pull-through is more likely to occur in rivets that have smaller size grip ranges.

As with solid rivets, blind rivets should not be positioned too close to the edge of a joint subjected to structural loading. The centreline of the rivet hole should be at least equal to the diameter of the rivet. In a standard blind rivet, a piece of the mandrel is

left inside the body when the mandrel breaks. Over time, there's a possibility that the leftover mandrel could shake loose. It won't affect the strength of the rivet, but it could cause a pesky noise, especially if the rivet is exposed to vibration. Closed-end rivets can avoid that problem. In a closed-end rivet, the mandrel and ball are inside the body. The end of the rivet is sealed. Closed-end rivets also prevent the passage of vapor or liquid through the placed fastener. They offer greater shear and tensile strength than open-end rivets. Closed-end rivets are ideal for electric or electronic assembly applications.

One of the most common problems that occurs when using a hand- or air-operated threaded-insert setting tool is the breakage of the mandrel or stripping of insert threads during the setting process. Each threaded insert has a very specific grip range associated with its thread size. The grip range is the total thickness of the material that the threaded insert will be set into. For example, if you are setting a threaded insert into a 0.21-inch thick material, you must select a threaded insert that has a grip range that covers the same thickness. A threaded insert indicating a grip range of 0.125 to 0.25 inch would be the correct choice.

### **2.3 Self-Pierce Riveting**

Self-piercing riveting is a high-speed mechanical fastening technique for point joining of sheet material components. A semi-tubular rivet is driven into the materials to be joined between a punch and die in a press tool. The rivet pierces the top sheet and the die shape causes the rivet to flare within the lower sheet to form a mechanical interlock. The rivet may be set flush with the top sheet when using a countersunk rivet head. The die shape also causes a button to form on the underside of the lower sheet; ideally, the rivet tail should not pierce this button as shown in figures 14 and 15.

Self-piercing riveting is used in many industries, as it is a simple and one-step joining technique. As it relies on a mechanical interlock rather than fusion, it can be used on materials and combinations of materials, where, for instance, resistance spot welding is difficult or even impossible. Self-piercing riveting is used for joining heavily zinc-coated steel sheets in the automotive, heating, ventilation and building industries, for pre-painted steels for white goods, and for joining aluminium alloys which are used for road sign manufacture or in the automotive industry [14].

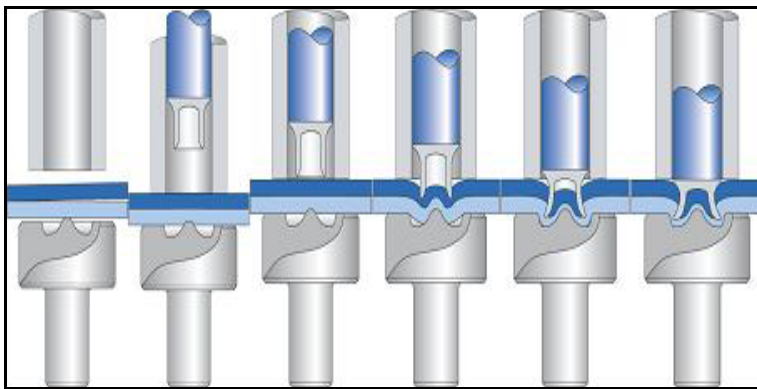


Figure 14 Self-Pierce Riveting [15]

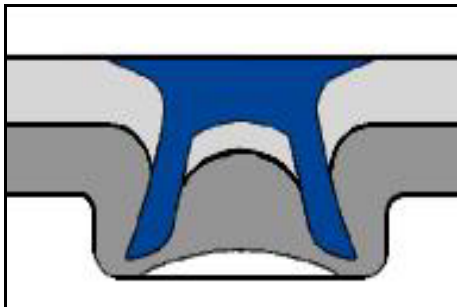


Figure 15 Self-Pierce Riveting [16]

### Important issues

According to TWI world centre for materials joining technology [17], the forces, for self-piercing riveting are high, are typically 30 to 50kN. This necessitates large stiff C-frames, particularly if long reach is required. For robotic applications, these C-frames are too heavy, and lightweight equipment would be required. As many

industries (e.g. automotive) are driven by weight-reduction, manufacturers are moving towards thinner and stronger materials. These may be less suitable for self-piercing riveting, due to a lower ductility and elongation. However, further process optimisation for those specific materials may make self-piercing riveting feasible [17].

### **Benefits**

According to TWI world centre for materials joining technology [17], the main benefits of self-piercing riveting are:

- Simple, one-step process with no pre-drilled holes required.
- Fast, automated operation possible.
- Suitable for many different materials and materials combinations.
- Little or no damage to pre-coated materials.
- Joining of more than two sheets possible.
- No fume or heat and low noise emission.
- Long tool life (typically greater than 20000 joints).
- Low energy demand.
- Process monitoring equipment available.
- Good fatigue performance, often better than spot welds.

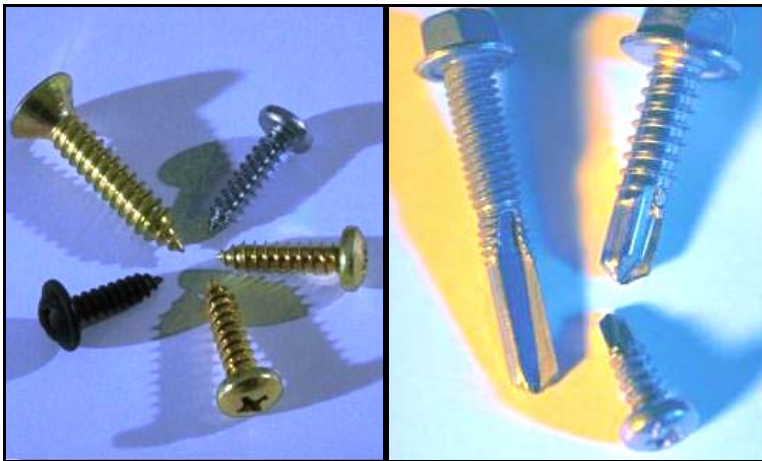
## **2.4 Screw Fastening**

Screw fastening technique is used for structural assembly in a wide range of engineering applications, particularly where high strength is required. They can also be found in smaller form in for example components where de- and re-assembly may be required e.g. in domestic appliances. Self-drilling screws may be used without the

need for pre-drilled holes. In thin materials, a screw with a special tip can be used to flow drill the hole in the material, providing additional thread engagement [18][19].

Self-tapping or thread-forming screws, on the other hand, require no nuts or tapped holes. Mostly used with pre-drilled holes although self-drilling screws are available, the screw forms a thread in the materials being joined when inserted, avoiding the need for tapping of the hole or for access to both sides. Flow drilling causing the material around the hole to be extended beyond the normal material thickness usually provides enough material for thread engagement, although if required an additional nut or clip may be used.

Self-drilling screws may be used without the need for pre-drilled holes. In thin materials, a screw with a special tip can be used to flow drill the hole in the material, providing additional thread engagement [19] [20]. Some of the common fasteners that are used for industrial purpose are shown in figure16.



**Figure16 Fasteners used in sheet metal [21]**

### **Benefits**

According to mechanical components course notes and Penn Fast Fastening Products, the benefits of using the above mechanical fastening techniques include:



- Joining of non-metals and dissimilar materials is feasible.
- Simple technique.
- Long tool life.
- Easy disassembly and re-assembly possible in the case of threaded fasteners.
- No pre-drilled hole required for self-drilling fasteners.
- Mechanized systems available.
- Low energy demand.
- Environmentally and user friendly.

## **2.5 Laser Welding**

Laser Beam Welding belongs to the category of welding processes that utilize light as the source of power for generating heat for welding. The principle of Laser is the use of stimulated energy to produce a beam of coherent light monochromatic that is in phase and has the same plane of polarization. When the beam is focused onto a small spot and there is sufficient energy, welding operation can be performed as shown in the figure 17.

Laser beam welding is a fusion joining process that uses the energy from a laser beam to melt and subsequently crystallize a metal, resulting in a bond between parts. Laser beam welding can be successfully used to join many metals to themselves as well as to dissimilar metals. Main applications are related to welding steels, titanium, and nickel alloys.

A high quality laser beam may be focused to a very small point, providing enough power density to enable keyhole welding. Keyhole welding is a method of laser welding in which the laser beam creates a vapour cavity in the part to be welded, which is then filled in with liquid metal. This process allows welding to occur with minimal heat input, resulting in low thermal distortion, which makes it ideal for welding thin sections and heat sensitive parts.

The advent of higher average powers, improved beam focusing systems and better beam quality has led to power density sufficient to overcome the high surface reflectivity of aluminium. Some alloys are prone to cracking, but optimization of the welding conditions and use of filler wire can eliminate this problem. Wire feed is also used for improving weld metal properties and tolerance to joint fit-up [22].

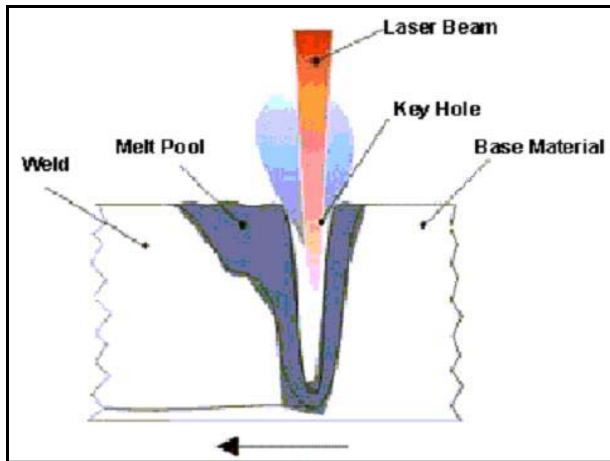


Figure 17 Laser Welding [23]

Sheet metal welding with a CO<sub>2</sub> laser beam is increasingly used in the manufacturing industries because of increased requirements concerning precision, flexibility and degree of automation. Realization of the CO<sub>2</sub> laser's installation will depend on exploiting its capabilities.

Therefore, according to TWI world centre for materials joining technology [22], the effects of variations in the following process parameters on the sheet metal welding have been studied:

- Focal position and range.
- Relation between output power and welding speed.
- Shielding gases.
- Deviations of laser beam.

Subsequently, some limitations of CO<sub>2</sub> laser welding for the following common welding joints have also been investigated:

- Overlap welding of two different materials.
- Butt joints.
- Overlap joints.
- Flange joints.

It can be concluded that the CO<sub>2</sub> laser can well tolerate some variations of process parameters, but for a good welded quality the combination of output power, welding speed, focal position, shielding gas and positioning accuracy should be correctly selected [22][24].

#### **Lasers are capable of welding**

- C-Mn steels
- Stainless steels
- Aluminium alloys
- Nickel alloys
- Titanium alloys
- Plastics

#### **Advantages of Laser Welding**

- Gas-tight weld
- No contamination by particles
- Perfect appearance
- Highly reproducible

## 2.6 Projection Welding

Projection welding is a development of resistance spot welding. In spot welding, the size and position of the welds are determined by the size of the electrode tip and the contact point on the work pieces, whereas in projection welding the size and position of the weld or welds are determined by the design of the component to be welded. The force and current are concentrated in a small contact area that occurs naturally, as in cross wire welding or is deliberately introduced by machining or forming. An embossed dimple is used for sheet joining and a 'V' projection or angle can be machined in a solid component to achieve an initial line contact with the component to which it is to be welded [25][26].

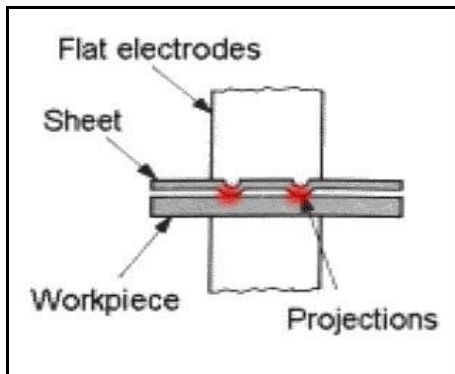


Figure 18 Projection Welding [27]

If the cross section of metal in the projection is fractured, the heat build up will form more rapidly in the stretched material than at the workpiece interface area. This will result in the projection collapsing before fusion takes place. When the projection is totally collapsed, further growth of a weld nugget will be impossible since the large surface of the copper electrodes will diffuse current density when the electrodes make full contact to the workpiece.

In sheet joining using embossed projection welds, a melted weld zone is produced, as in spot welding. However, when a solid formed or machined projection is used, a solid phase forge weld is produced without melting. The plastic deformation of the

heated parts in contact produces a strong bond across the weld interface. The process is widely used on sheet metal assemblies in automotive and white goods industries for both sheet joining and attaching nuts and studs [26].

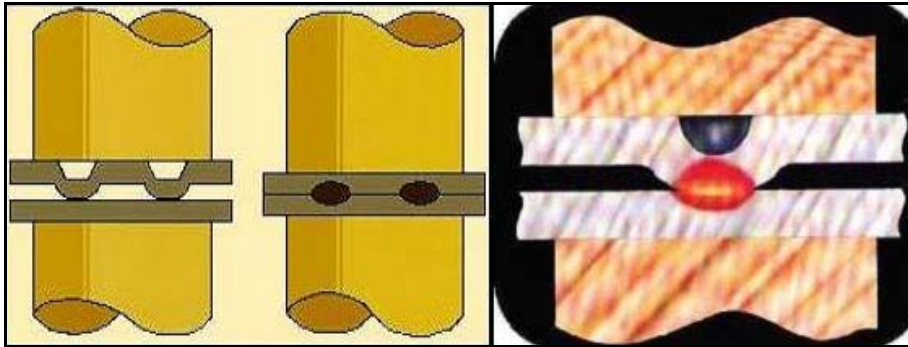


Figure 19 Projection Welding [26]

### Benefits

According to TWI world centre for materials joining technology [26] and Designinsite Welding firm, the advantages of projection welding include its versatility, the speed and ability to automate, the ability to make a number of welds simultaneously and minimization of marking on one side of joints in sheet materials. Capacitor discharge supplies used with machined annular projections can compete with power beam welding, as the weld is completed in a single shot within milliseconds.

### Limitations

According to TWI world centre for materials joining technology [26], there are some limitations on material weldability but attention to correct setting up and good process control can solve most production problems. The main safety factors are trapping hazards and splash metal. Little fume is produced but may need attention when welding coated steels or when oils or organic materials are present.

## 2.7 Adhesive Bonding

Adhesive bonding is an efficient and reliable joining process for a wide range of materials, components and operating conditions, because of the many advantages it has to offer, adhesive bonding can often replace a wide variety of traditional assembly techniques. In order to get the best performance from an adhesive bond it is important to design the component taking a design made for other methods. When we bond components together the adhesive first thoroughly wets the surface and fills the gap between, then it solidifies. When solidification is completed the bond can withstand the stresses of use. Some of the possible joint designs are shown in figure 20.

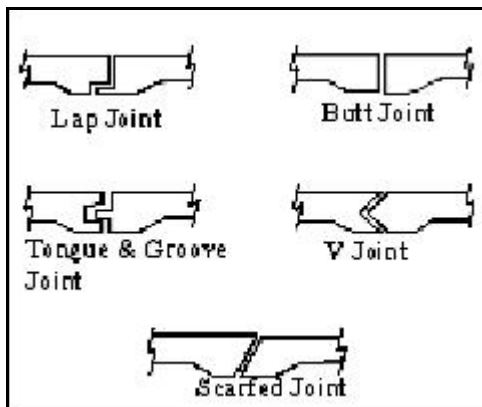


Figure 20 Joint Designs for Adhesive Bonding [28]

A smooth, bonded surface can help reduce drag because a fastener does not interrupt the contour of the part surface. Time-consuming operations required to remove welding slag and prepare the surface for finishing can be avoided with adhesives.

Adhesives allow assemblers to bond dissimilar metals as shown in figure.21, without promoting galvanic corrosion. They allow the bonding of coated, galvanized or painted metals without negatively affecting the surface finish. And, they can act as a dielectric insulator between components [28].

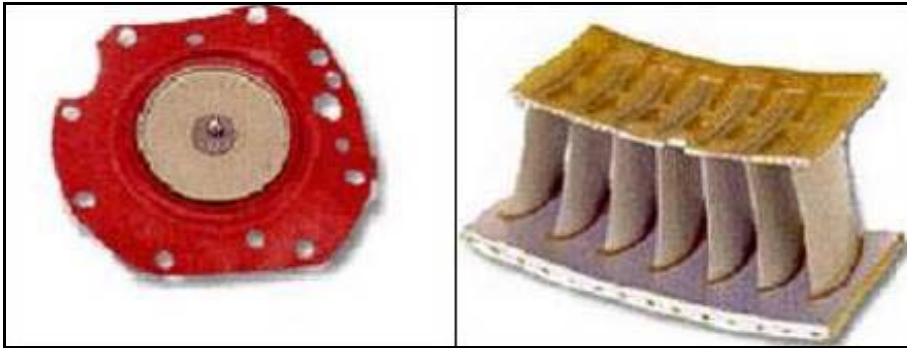


Figure 21 Bonded joints [29]

### Designing a bonded joint

According to Robert D. Adams, when designing bonded joints, the following considerations must be included for better results:

- Joint geometry.
- Adhesive selection.
- Mechanical properties of adhesive and adherent.
- Stress in the joint.
- Manufacturing conditions.

Bonded joints may be subjected to tensile, compressive, shear or peel stresses, often in combination. Adhesives are strongest in shear, compression and tension. They perform less effectively under peel and cleavage loading. A bonded joint needs to be designed so that the loading stresses will be directed along the lines of the adhesive's greatest strengths [28].

### Types of adhesives and their characters

Modern adhesives are classified either by the way they are used or by their chemical type. The strongest adhesives solidify by a chemical reaction. Less strong types

harden by some physical change. Key types in today's industrial scene are as follows [30].

**Anaerobics:** Anaerobic adhesives harden when in contact with metal and air is excluded, e.g. when a screw is tight in a thread. Often known as 'locking compounds' or 'sealants', they are used to secure, seal and retain turned, threaded, or similarly close-fitting parts. They are based on synthetic resins known as acrylics. Due to the curing process, anaerobic adhesives do not have gap-filling capability but have advantage of relatively rapid curing.

**Cyanoacrylates:** A special type of acrylic, cyanoacrylate adhesives cure through reaction with moisture held on the surfaces to be bonded. They need close-fitting joints. Usually they solidify in seconds and are suited to small plastic parts and to rubber. Cyanoacrylate adhesives have relatively little gap-filling capability but can be obtained in liquid and thixotropic (non-flowing) versions.

**Toughened Acrylics/Methacrylates:** A modified type of acrylic, these adhesives are fast curing and offer high strength and toughness. Supplied as two parts, resin and catalyst, they are usually mixed prior to application.

**UV curable adhesives:** Specially modified acrylic and epoxy adhesives, which can be cured very rapidly by exposure to UV radiation. Acrylic UV adhesives cure extremely rapidly on exposure to UV but require one substrate to be UV transparent. The UV initiated epoxy adhesives can be irradiated before closing the bond line, and cures in a few hours at ambient temperature or may be cured at elevated temperature.

**Epoxies:** Epoxy adhesives consist of an epoxy resin plus a hardener. They allow great versatility in formulation since there are many resins and many different hardeners. They form extremely strong durable bonds with most materials. Epoxy adhesives are available in one-part or two-part form and can be supplied as flowable liquids, as highly thixotropic products.



**Polyurethanes:** Polyurethane adhesives are commonly one part moisture curing or two-part. They provide strong resilient joints, which are resistant to impacts. They are useful for bonding glassfibre-reinforced plastics and certain thermoplastic materials and can be made with a range of curing speeds and supplied as liquids or with gap-filling capability of up to 25mm.

**Modified Phenolics:** The first adhesives for metals, modified phenolics now have a long history of successful use for making high strength metal-to-metal and metal-to-wood joints, and for bonding metal to brake-lining materials. Modified phenolic adhesives require heat pressure for the curing process.

The above types set by chemical reactions. Types that are less strong, but important industrially, are as follows:

**Hot Melts:** Related to one of the oldest forms of adhesive, sealing wax, today's industrial hot melts are based on modern polymers. Hot melts are used for the fast assembly of structures designed to be only lightly loaded.

**Plastisols:** Plastisol adhesives are modified PVC dispersions that require heat to harden, the resultant joints are often resilient and tough.

**Rubber adhesives:** Based on solutions of latexes, rubber adhesives solidify through loss of solvent or water. They are not suitable for sustained loading.

**Polyvinyl Acetates:** Vinyl acetate is the principal constituent of the PVA emulsion adhesives. They are suited to the bonding of porous materials.

**Pressure-sensitive adhesives:** Suited to use on tapes and labels, pressure-sensitive adhesives do not solidify but are often able to withstand adverse environments. They are not suitable for sustained loading.

### **Advantages of Adhesive Bonding**

According to Huntsman's user guide to adhesives [30], the following are the advantages of the adhesive bonding:

- More uniform stress distribution.
- Materials of varying types and thickness can now be assembled.
- The material around the joint is little subject to alteration: bonding temperatures are not excessively high, parts are not pierced, and there is no electrochemical corrosion.
- Elasticity of adhesive joints: vibrations are attenuated.
- Adhesive joints can provide impermeability to air and water as well as insulation against electricity, electro-magnetic waves, Etc.
- Structures are lighter.
- Adhesive bonding gives clean-looking results.
- Production cost is generally lower than with traditional assembly methods.
- The assembly operation can be easily automated to achieve high production rates.
- Adhesive joining methods typically offer significant material and labour cost savings over welding and mechanical joining methods.

### **Limitations**

According to Huntsman's user guide to adhesives [30], and Robert D. Adams [28], there are some limitations that are given below:

- Resistance to heat is often limited.
- Chemical resistance depends on environment.
- Mid-term durability in harsh environments.
- Surface treatments often require.

- Low resistance to peel stress.
- Disassembling is difficult.
- Bonding time can be long in some cases.

## **2.8 Hybrid Joining**

The various methods explained above have advantages as well as disadvantages. By combining the benefits of two methods and utilizing those cancels out some disadvantages and hence gives rise to a new method with more advantages. The combination of methods like adhesive bonding and mechanical joining, which includes clinching, riveting and screw fastening can be developed which can be termed as hybrid joining. This technique can be used as a good replacement for the traditional joining methods. In this technique, the limitations of the mechanical joining and adhesive joining overcome and thus provide a good industrial future [31].

### **Advantages**

According to Global Spec. The Engineering Search Engine [35], the advantages of hybrid joining includes:

- Method will be considered good alternative for sheet metal products.
- Resistance provided to bonding will be better than with that of adhesive bonding.
- Lifetime of the product can be increased as it can offer more durability to harsh environments.
- The amount of the surface treatment will be less when compare to adhesive bonding
- More stress resistant.
- Disassembly is comparatively less complicated then adhesive bonding.

- Bonding time of the joints can be shortened.
- Less economical compared to adhesive bonding.

### **Limitations**

According to Global Spec. The Engineering Search Engine [35], the limitations of hybrid joining are as follows:

- It needs careful implementation of both joining methods adhesive bonding and mechanical joining.
- It cannot provide smooth surfaces as adhesive bonding because this method includes mechanical joining methods.

### **2.9 Self Clip**

Self-Clip joining technique is a traditional method that is used for many decades; due to its various drawbacks it is not so successful. It can be better to amalgamate this method with some other joining method make it more efficient and economical. This joining technique can be used in sheet metal production, which is applicable to all materials with good bending properties. This method is individually not so successful and when it used with the combination of mechanical joining methods such as clinching, riveting and screw fastening, it will prove to be more efficient [32].



**Figure 22 Self-Clip [33]**

**Advantages**

According to U.S. Patent, online database [33], there are several advantages of slip clip mentioned below:

- More flexible in assemble and disassemble of the joints.
- Professional skill requirements are minimal.
- Low energy consumption.
- Low investments.

**Limitations**

According to U.S. Patent, online database, there are some limitations of slip clip mentioned below:

- This method is not so successful individually.
- Stiffness of the joint can be less.
- Application of load on the product is not recommendable.

### 3 CONCEPTION OF THE TABLE

As already mentioned there are different joining methods for manufacturing the sheet metal based products. To select the most suitable joining process some criterion is sought, on basis of which the performance of the sheet metal production method can be evaluated. On the basis of various joining processes and concerned references a table has been generated, containing a set of criterion that helps in evaluation of those various sheet metal joining processes and in selecting the most suitable process for a particular product.

The suitability of the joining method for various types of cases of different sheet metal products can be tested with the help of this table. This table contains four sections, which display the requirements of manufacturing. The important factor has been considered and given focus in the table, as how the usage of these parameters is important in percentages according to particular or individual case.

The main factors such as reproducibility, corrosion, pre-processing and joint tightness are considered for the evaluation and selection process for the best possible joining method of sheet metal products in this work. The table generated gives a clear idea in understanding the relationship between the joining methods and the factors affecting it; it compares different joining methods and also illustrates the extent upto which they fulfil the requirements.

In cases where the joining methods are closely related to the requirements of the joining process, the method for joining may be chosen by comparing their cost effectiveness. Many products and appliances may not require too complicated manufacturing processes, as it may increase unnecessary costs. Therefore, a common balance should be obtained while choosing the joining method considering all the parameters and requirements as well as the economic aspects.

### 3.1 Experimental Set-Up

In the experimental table (see table 1), nine joining methods and the required parameters are deliberated. The considered parameters are divided into four sections; the division does not refer to any particular ground, but is merely for the ease of the user. The comparative grading given for each parameter towards the method is on the basis of available information and data about the methods.

Table1 is generated for the sheet metal products, each method has some comparative advantages and disadvantages and this makes the selection multipart. The selected method in each case may not be the only premium and best feasible method; there has sometimes been a negotiation on some parameters while comparing the two methods with assorted but superior features. Application of this table is further shown in the experimental part.

Sections	Methods Parameters	Importance in % according to the case	Mechanical Joining				Thermal Joining		Other Processes		
			Clinching	Blind Riveting	Self Pierce riveting	Screw fastening	Laser Welding	Projection Welding	Bonding	Hybrid Joining	Self clip
Section I	A <sub>1</sub>										
	B <sub>1</sub>										
	C <sub>1</sub>										
	D <sub>1</sub>										
	E <sub>1</sub>										
Section II	A <sub>2</sub>										
	B <sub>2</sub>										
	C <sub>2</sub>										
	D <sub>2</sub>										
	E <sub>2</sub>	E <sub>21</sub> E <sub>22</sub>									
Section III	A <sub>3</sub>										
	B <sub>3</sub>										
	C <sub>3</sub>										
	D <sub>3</sub>										
	E <sub>3</sub>										
Section IV	A <sub>4</sub>										
	B <sub>4</sub>										
	C <sub>4</sub>										
	D <sub>4</sub>										

**Table 1**

- A<sub>1</sub> Materials
- B<sub>1</sub> Possibility of joining different materials
- C<sub>1</sub> Corrosion of material at the joints
- D<sub>1</sub> Possibility of joining fragile parts
- E<sub>1</sub> Dependence of joint result on surface quality
  
- A<sub>2</sub> Pre-processing
- B<sub>2</sub> Reachability
- C<sub>2</sub> Dynamic load-resistance
- D<sub>2</sub> Static Load Resistance
- E<sub>2</sub> Crush load-resistance
- E<sub>21</sub> *Shearing stress*
- E<sub>22</sub> *Head stress*
  
- A<sub>3</sub> Joining and strength alteration at joining point
- B<sub>3</sub> Joining consumable required
- C<sub>3</sub> Heating disadvantages
- D<sub>3</sub> Tightness
- E<sub>3</sub> Environmentally friendly
  
- A<sub>4</sub> Reproducibility
- B<sub>4</sub> Edges - Burning - Splinters
- C<sub>4</sub> Professional Skills
- D<sub>4</sub> Energy consumption



### **3.2 Description of Parameters**

The parameters displayed in experimental table are liable to affect the various joining methods depending upon the product concerned. Parameters that are prone to have a significant role in the selection of the appropriate joining method, are described according to the correlated study as described below:

#### **Materials**

Sheet metal involved in production of various products makes use of different materials for their respective purposes or applications. Materials such as steel sheets, aluminum-plated steel sheets, zinc-plated steel sheets, and aluminum sheets are commonly used in a wide range of fields related to automobiles, building materials, and consumer mechanical, electrical and electronic products.

The metal must be worked, or shaped into certain forms for use in industry. Metalworking is divided into two basic types: cold working, in which the metal is shaped after it has crystallized, and hot working, in which the metal is worked while soft. The study of the relationship between a metal's structure and its mechanical properties is known as physical metallurgy.

The physical properties of most metals include high density, or high mass per unit volume, and high strength, or the ability to resist being distorted from their original shape. Most metals also have great plasticity: they can change their shape without breaking. Zinc and aluminum, however, corrode in the atmosphere and generate corrosion products (known as white rust), which mar the appearance of the metal material and also adversely affect the paintability of the material.

The physical properties such as corrosion, workability, possibility of joining different materials and environmentally friendly, help us to select materials for joining according to the purpose of the application of the product. Furthermore, the material

is susceptible to fingerprints and other soiling when handled by workers in the course of the various steps of manufacturing the finished product at the user's plant; such soiling can markedly lower the commercial value of the product. Also, oils and the like are used as lubricants in pressing and other such working of the material, and this oil has to be removed after forming [34][35][36][43].

### **Possibility of joining different materials**

Sometimes, the requirement of the product to be manufactured is to have a part fabricated from two different types of materials. It can happen when the in-service conditions vary over the area of the product. Mechanical joining methods get advantage over the welding because the former doesn't need to melt the parts to join them.

Hence, the difference in chemical and physical composition of the two parts to be joined, doesn't affect the quality of the joint and as a result its strength. For example, laser welding of aluminium and stainless steel is not very practical because the melting point of aluminium and melting point of steel.

The joining methods such as clinching, riveting, screw fastening, adhesive bonding and self-clip have an advantage over welding processes that the selection process of different materials for joining may not be a tough task. This is due to the fact that there is no chemical and physical interaction between the materials, which would affect the joint of the product [37].

### **Corrosion of material at the joints**

Corrosion of material at the joints meant that the occurrence of the corrosion related to the selection of the manufacturing method. There are several methods, which are used to prevent these kinds of problems in the product. It will be understood that the various cleaning and pre-treatment steps can be performed with any variations desired

by the user. Coatings are applied in order to improve the appearance of the metal, prevent corrosion, stop unwanted chemical reactions with other materials, or otherwise preserve the surface. The most usual coatings are tin, zinc, nickel, chromium, cadmium, copper, aluminum, and bronze and paint, varnish, enamel, and lacquer [38].

The methods like coating find particular application in the treatment of small metal parts that are handled in bulk, which include, for example, nuts, bolts, screws, subassemblies, fasteners, clips stampings and brackets, such as those used in the manufacturing field. Therefore, corrosion of material due to joining is one of the important requirements while selecting the method for joining and coatings for the material is a solution for the problem [36].

### **Possibility of joining fragile parts**

In manufacturing, few complications could occur while joining fragile parts. It may be necessary to consider the joining of fragile parts according to the requirement of the particular case. The joining relates generally to methods and structures for joining a first part to a second part.

A problem relates to the forces that act upon such fragile parts. The forces that act upon a fragile part as a consequence of joining with another part could result in exceeding material property limits of the fragile part, leading to its destruction. A problem can also relating to differences in thermal expansion is that, when the joined parts are subjected to thermal cycling. In some joining methods due to improper fitting, play can develop in the joint so that the joint loosens and allows the parts to move with respect to each other, which is undesirable [8][11][35][43].

According to TWI world centre for materials joining technology [43] and Global Spec. The Engineering Search Engine [35], the requirement for joining of fragile parts for various methods are mentioned below:

- Clinching and Self Pierce Riveting both don't require pre-processes like drilling but demands high investments and are of limited applicability, limited choice of materials, non-fragile parts and low tolerances.
- Blind Riveting is highly versatile with controlled investments; it ensures high quality joints between different materials, non-metals and even fragile parts.
- Screw Fastening is labour intensive and difficult to automate and therefore expensive in medium to high production runs.
- Laser welding can be useful in joining fragile parts if the factors like laser power intensity, type of laser and other laser parameters are controlled according to the requirement.
- Projection Welding is even less versatile than Clinching and Self Pierce Riveting. The changes it brings to material structures and internal stresses make it even worse.
- Adhesive bonding is a new and promising joining technology for high-tech applications or mass production of high-performance products.
- Hybrid joining method has an advantage over other methods where it has benefits of two different methods. This method yields in more options for selection of materials.
- Self-clip being very useful in joining materials, it has a disadvantage in joining of fragile materials due to some physical properties of the materials. This can be overcome by introducing this method along with any mechanical joining method.

### **Joint result on surface quality**

Joint surface quality and shape do matter in many cases, especially in the products that have to go through variable stresses. Therefore the maintenance of the joint is more indispensable in order to avoid any kind of stress concentration; for example, in laser welding, the joint has even stress surface finish while in clinching, riveting and screw fastening, use of stress raisers is inevitable. Every joining technique may have

different methods for controlling the above-mentioned factors whilst maintaining the surface quality of the material [39].

### **Pre-processing**

In the phase of pre-processing there are all steps that hang together with the preparation for the manufacturing stages. It can be enhancement, transformation, or filtering before processing. In the selected manufacturing methods, some of the methods need pre-processing and some methods do not need pre-processing [8][14][22][28].

According to TWI world centre for materials joining technology [22], Assembly Magazine [14], and Robert D. Adams; Structural Adhesive Joints in Engineering [28], the requirement for pre-processing for various methods are mentioned below:

- Clinching and Self Pierce Riveting both don't require pre-processes like drilling.
- Blind Riveting and Screw fastening method needs drilling, it ensures high quality joints between different materials.
- Projection Welding and Laser Welding methods do not require processes like drilling, but they require pre-processes like surface cleaning and etching.
- In Adhesive Bonding, curing must be performed at required conditions like time, temperature and relative humidity. Design must account for fatigue loads, temperature of operation, surface preparation and gap filling.

### **Reachability**

Reachability of the joint or joint accessibility plays an important role in order to make the joining method more flexible. The ease of the access of joint location; more is the flexibility of production. Some joining methods may give advantage over other, for

example, laser welding, screw fastening, self-clipping and bonding can be accessed from one side. This is not the case with clinching, self-pierce riveting and projection welding.

On the other hand, clinching, self-pierce riveting and spot welding can be advantageous when the joint has to be made with a small tolerance from the free end. This cannot be done easily with laser welding, screw fastening, self-clipping or bonding. Hence, reachability is a major factor or requirement while selecting the joining method [8][14][19][22].

### **Load-resistance**

The selected process needs to be resistant to a load imposed by dynamic action, as distinguished from static load. It can also be mentioned as the output load that changes rapidly, normally specified as a load change value as well as a rate of change. The joints must have to be strong to withstand the loads and overcome problem like vibrations, which may be experienced by the product in use. The product may experience many different kinds of loads in its life. Therefore, a good joining method has to be selected for the best performance of the product [40].

### **Heating disadvantages**

The joining processes, which involve heating, sometimes change the chemical as well as physical properties of the material to be joined at the joining interface. The change in the property of the joining part is because of the change in microstructure of the welded part. This doesn't happen in the case of mechanical joining methods. Welding metallurgy and phase diagrams shows that some changes happen in the microstructure of the welded material when it is heated to very high temperature and then suddenly cooled down to room temperature [35].

This heating and subsequent cooling during welding processes may tend to form different phase structure such as austenitic, martensitic and pearlitic and consequently difference in the mechanical strength properties of the joint surface. This is not the case in mechanical joining methods, adhesive bonding and self-clipping, where change in the properties will not occur.

### **Environmental friendly**

Environmental conditions play an important role in the life of joints and affect different joining methods in different ways according to joint properties. For example, welded joint corrodes easily in the presence of moisture or other corrosive elements in the atmosphere like, sulphuric acid, carbonic acid etc.

Welding processes may render the material to corrosion more easily than other methods. Advanced joining methods, such as laser welding, have more safety precautions and other necessary steps that make the joint environmental friendly. Mechanical joining methods are more beneficial in this area of environmental considerations.

Joints, which are usually adhesive bonded, tend to lose their bonding capability when exposed to extreme conditions in the ambient atmosphere, but in no way the joint leaves any adverse effect on the environment. This method shows good joining properties when it is maintained according to the requirements and parameters [31][35].

### **Reproducibility**

In the lifetime of a product, it might be required for the product to be disassembled and assembled again for the purpose of maintaining, servicing or replacing parts. According to this property of reproducibility, selection of a suitable joining method is

essential for better performance of the product. The less damage done during disassembling, the more easy and economical it is to reproduce any product.

Screw fastening and self-clip is more flexible and advantageous as far as the reproducibility is concerned. In joining methods such as welding, clinching or adhesive bonding, the joints tend to distort the parts when it gets separated from the joint and hence not recommendable where the in service conditions are harsh and can damage the product, which needs to be reproduced [41][42].

### **Edges - Burning - Splinters**

Edges in the joining process may be of importance where precision of the product is more important. In laser welding and adhesive bonding, the tolerances are adjusted in such a way that the resulting joint has smooth edges, which is also maintained. In processes like mechanical joining, this requirement has to be taken care for creating smooth edges and also maintaining it.

Burning of the metal area around the joints is commonly found in processes where high energy and heat is involved for joining. Laser welding and projection welding have relative heat affected zones where the burning of metal might be found. Other methods like mechanical joining, adhesive bonding, clinching or riveting have relatively less chances of burning.

Splinters are formed in joining methods where the process of joining creates sharp and slender pieces of metal, split or broken off from the main body of the product. These are commonly found in processes such as mechanical joining, clinching or riveting, where the process involves removal of metal or deformation of the metal. Processes such as spot welding, laser welding and adhesive bonding have an advantage in terms of formation of splinters [35][39].



### **Professional Skills**

Professional skills of the person engaged in handling the process is also an important requirement when the process is advanced and automated. Due to this reason, the selection of the joining process becomes tedious, as we may have to consider other aspects. For example, laser welding needs high professional skills while the mechanical joining methods do not need high professional skills. Fewer requirements of professional skills make the process more flexible.

In joining methods such as clinching, riveting, adhesive bonding and other mechanical methods, process is easy to be performed by a relative less professional labour while the laser welding needs the worker to be professionally well trained. This is due to the fact that laser welding method involves high level of automation and the person handling or controlling should be a professional who should be able to understand the principle, working, safety, joining requirements, etc [1].

### **Energy consumption**

The fact that every joining process consumes energy is also important when considering the economical point of view. Energy consumption depends on the degree of automation of the process and the level of complexity of the machinery used for joining. Advanced processes, like laser welding consume more energy as compared to traditional mechanical joining methods. This may be due to the fact that laser requires higher power for better performance.

The degree of energy consumption also varied for different joining methods. Projection welding, adhesive bonding and hybrid joining also consume some amount of energy as compared to mechanical joining methods. The mechanical joining methods and self-clipping are more advantageous in terms of energy consumption as compared to the other joining methods mentioned above [39][43].

## 4 RESULTS

By considering the applications, advantages, disadvantages and assessment of the joining methods, the table has been created. The considered parameters are divided into four sections, the division does not refer to any particular grounds but it was merely for the ease of the user. The grading against each method for each parameter was done on the basis of available information and data about the methods.

The constructed table gives opportunity to select the method flexibly. The analysis of nine different joining methods has been done in the table and can be used while making further consideration for other cases. The analysis of the methods can be extended or altered by changing the parameters according to the constraint. The use of this table is flaunted by pertaining the cases from sheet metal production.

The three sheet metal products (washing machine, light fixture and cupboard) selected in the work have been labelled as case 1, case 2 and case 3, and are displayed in table 2, table 4 and table 6 respectively; the associated results are also listed in the same tables. The assessment of these results has been made after the thorough inspection of the outcome of this work.

#### 4.1 Case 1, Washing Machine

Sections	Methods Parameters	Importance in % according to the case	Mechanical Joining				Thermal Joining		Other Processes			
			Clinching	Blind Riveting	Self Pierce Riveting	Screw Fastening	Laser Welding	Projection Welding	Bonding	Hybrid Joining	Self clip	
Section I	A <sub>1</sub>	50	Only metals	All solid materials	Only metals	All solid materials	Weldable metals, Polymers	Only some metals	All solid materials	All solid materials	Metals with good bending properties	
	B <sub>1</sub>	0	4	5	4	5	4	0	5	5	4	
	C <sub>1</sub>	10	3	3	3	3	3	1	5	3	3	
	D <sub>1</sub>	0	0	5	0	4	4	0	5	4	0	
	E <sub>1</sub>	0	3	5	5	3	0	1	0	1	5	
Section II	A <sub>2</sub>	5	5	4	5	3	1	2	2	1	5	
	B <sub>2</sub>	0	4	4	4	4	3	4	4	4	4	
	C <sub>2</sub>	0	5	4	5	2	5	2	5	5	2	
	D <sub>2</sub>	10	2	2	3	2	5	2	3	5	2	
	E <sub>2</sub>	E <sub>21</sub>	0	4	5	5	5	5	5	4	5	4
		E <sub>22</sub>	0	4	5	5	5	5	5	4	5	4
Section III	A <sub>3</sub>	0	5	5	5	5	2	2	5	5	5	
	B <sub>3</sub>	5	5	3	3	3	3	5	3	3	5	
	C <sub>3</sub>	0	5	5	5	5	3	1	5	5	5	
	D <sub>3</sub>	10	3	3	3	3	5	5	4	4	2	
	E <sub>3</sub>	0	4	4	4	4	4	1	5	4	4	
Section IV	A <sub>4</sub>	10	1	3	1	5	1	1	1	1	5	
	B <sub>4</sub>	0	5	5	5	3	5	3	5	5	5	
	C <sub>4</sub>	0	5	5	5	5	2	5	5	5	5	
	D <sub>4</sub>	0	4	4	4	4	0	0	0	3	4	
<b>Total Points</b>			<b>140</b>	<b>145</b>	<b>140</b>	<b>160</b>	<b>160</b>	<b>125</b>	<b>155</b>	<b>150</b>	<b>170</b>	

Table 2

A<sub>1</sub> Materials  
 B<sub>1</sub> Possibility of joining different materials  
 C<sub>1</sub> Corrosion of material at the joints  
 D<sub>1</sub> Possibility of joining fragile parts  
 E<sub>1</sub> Dependence of joint result on surface quality

A<sub>2</sub> Pre-processing  
 B<sub>2</sub> Reachability  
 C<sub>2</sub> Dynamic load-resistance  
 D<sub>2</sub> Static Load Resistance  
 E<sub>2</sub> Crush load-resistance  
 E<sub>21</sub> *Shearing stress*  
 E<sub>22</sub> *Head stress*

A<sub>3</sub> Joining and strength alteration at joining point  
 B<sub>3</sub> Joining consumable required  
 C<sub>3</sub> Heating disadvantages  
 D<sub>3</sub> Tightness  
 E<sub>3</sub> Environmental friendly

- A<sub>4</sub>    Reproducibility  
 B<sub>4</sub>    Edges - Burning - Splinters  
 C<sub>4</sub>    Professional Skills  
 D<sub>4</sub>    Energy consumption

In case 1, the parameters considered (A<sub>1</sub>, C<sub>1</sub>, A<sub>2</sub>, D<sub>2</sub>, B<sub>3</sub>, D<sub>3</sub> and A<sub>4</sub>), have been assigned more significance as compared to other parameters because of the reasons given in table 3 below:

<b>Parameter</b>	<b>Reasons</b>
A <sub>1</sub>	The material selected has the highest significance because the material has to satisfy several requirements of design and manufacturing. Also the material selected should not influence or amend the preferred joining method.
C <sub>1</sub>	Along with the conditions of stress concentration at the joints, the usage of water in a washing machine raises the chances of several joints getting corroded.
A <sub>2</sub>	It is required so as to make the assembly of various parts of a washing machine feasible and effective.
D <sub>2</sub>	Washing machines are subjected to vibrations due to moving parts and sometimes even to overloading; hence the dynamic load resistance of the machine must be good enough to conform to these requirements.
B <sub>3</sub>	As a washing machine contains a large number of parts, the requirement of quality joining consumables is in equal proportion.
D <sub>3</sub>	Joint tightness has a great importance in case of washing machine that is subjected to cyclic loading. If there is any play in the joints, the cyclic loads coming on to the joints can lead to its failure.
A <sub>4</sub>	Reproducibility of the washing machine has a great importance, as it governs the possibility of the machine to get assembled and disassembled.

**Table 3**

In case 1, after analysis of the parameters, self-clipping method is the resultant selected method but it does not have very wide applications in practice. The reasons may be that it needs more experimental and research work needed for its successful implementation. If some mechanical joining methods used as supportive method with self-clipping method, then self-clipping method can come up with good results. The second best possible joining method that can be selected are screw fastening and laser welding methods. Hence, the second best method in this case contemplation to fulfils the requirements efficiently.

The parameters that have been assigned less significance in this case, can have better application in some other cases, which depends upon several factors like designing methods used, manufacturing procedures adopted, environmental conditions, customer requirements etc.

## 4.2 Case 2, Light Fixture

Sections	Methods Parameters	Importance in % according to the case	Mechanical Joining				Thermal Joining		Other Processes		
			Clinching	Blind Riveting	Self Pierce Riveting	Screw Fastening	Laser Welding	Projection Welding	Bonding	Hybrid Joining	Self clip
Section I	A <sub>1</sub>	40	Only metals	All solid materials	Only metals	All solid materials	Weldable metals, Polymers	Only some metals	All solid materials	All solid materials	Metals with good bending properties
	B <sub>1</sub>	0	4	5	4	5	4	0	5	5	4
	C <sub>1</sub>	15	3	3	3	3	3	2	5	3	3
	D <sub>1</sub>	0	0	5	0	4	4	0	5	4	0
	E <sub>1</sub>	0	3	5	5	3	0	1	0	1	5
Section II	A <sub>2</sub>	10	5	3	5	3	1	2	2	1	5
	B <sub>2</sub>	0	4	4	4	4	3	4	4	4	4
	C <sub>2</sub>	0	5	4	5	2	5	2	5	5	2
	D <sub>2</sub>	0	2	2	3	2	5	2	4	5	2
	E <sub>2</sub>	E <sub>21</sub>	0	4	5	5	5	5	5	4	5
E <sub>22</sub>		0	4	5	5	5	5	5	4	5	4
Section III	A <sub>3</sub>	0	5	5	5	5	2	2	5	5	5
	B <sub>3</sub>	5	5	3	3	3	3	5	3	3	5
	C <sub>3</sub>	0	5	5	5	5	3	1	5	5	5
	D <sub>3</sub>	15	3	3	3	3	5	5	4	4	2
	E <sub>3</sub>	15	4	4	4	4	4	2	3	4	4
Section IV	A <sub>4</sub>	0	3	4	1	5	1	1	2	2	5
	B <sub>4</sub>	0	5	5	5	3	5	3	5	5	5
	C <sub>4</sub>	0	5	5	5	5	2	5	5	5	5
	D <sub>4</sub>	0	4	4	4	4	0	0	0	3	4
Total Points			225	195	215	195	205	180	215	190	210

Table 4

A<sub>1</sub> Materials  
 B<sub>1</sub> Possibility of joining different materials  
 C<sub>1</sub> Corrosion of material at the joints  
 D<sub>1</sub> Possibility of joining fragile parts  
 E<sub>1</sub> Dependence of joint result on surface quality

A<sub>2</sub> Pre-processing  
 B<sub>2</sub> Reachability  
 C<sub>2</sub> Dynamic load-resistance  
 D<sub>2</sub> Static Load Resistance  
 E<sub>2</sub> Crush load-resistance  
 E<sub>21</sub> *Shearing stress*  
 E<sub>22</sub> *Head stress*

A<sub>3</sub> Joining and strength alteration at joining point  
 B<sub>3</sub> Joining consumable required  
 C<sub>3</sub> Heating disadvantages  
 D<sub>3</sub> Tightness  
 E<sub>3</sub> Environmental friendly

- A<sub>4</sub>    Reproducibility
- B<sub>4</sub>    Edges - Burning - Splinters
- C<sub>4</sub>    Professional Skills
- D<sub>4</sub>    Energy consumption

In case 2, the parameters considered (A<sub>1</sub>, C<sub>1</sub>, A<sub>2</sub>, B<sub>3</sub>, D<sub>3</sub> and E<sub>3</sub>), have been assigned more significance as compared to other parameters because of the reasons given in table 5 below:

<b>Parameter</b>	<b>Reasons</b>
A <sub>1</sub>	The material selected has to satisfy several requirements of various stages involved in production. Also the material selected should not influence or amend the preferred joining method.
C <sub>1</sub>	The light fixtures that are used outdoors, can be subjected to severe environmental conditions like extreme temperatures, humid atmosphere etc. Hence the corrosion resistance of the joints used in light fixtures should be strong enough to fulfil the desired requirements.
A <sub>2</sub>	It is required so as to make the parts to be efficiently joined and make the product feasible and effectual.
B <sub>3</sub>	The joining consumables concerned in the case of light fixture are significant as they can affect the durability of the product and can also hamper the performance. The consumables are chosen such that they need no maintenance throughout the lifetime of the product.
D <sub>3</sub>	Joint tightness has a great importance in case of light fixtures that are used outdoors and should be strong enough to prevent the failure of the product due to harsh ambient conditions.
E <sub>3</sub>	The joining method implemented should not produce any harmful stuff along with the main product, which could lead to adverse effects on the environment.

**Table 5**

In case 2, which is of light fixture, after analysis of the parameters, clinching method has shown beneficial results in accordance for the parameters used for joining methods. This method fulfils the requirements of the product that can be contending with other joining methods. The second option in this case can be selected as self-pierce riveting and self-clipping method because it meets the need of the product.

The parameters besides these, can have better application in some other cases, which depends upon several factors like designing methods used, manufacturing procedures adopted, environmental conditions, customer requirements etc.



### 4.3 Case 3, Cupboard

Sections	Methods Parameters	Importance in % according to the case	Mechanical Joining				Thermal Joining		Other Processes		
			Clinching	Blind Riveting	Self Pierce Riveting	Screw Fastening	Laser Welding	Projection Welding	Bonding	Hybrid Joining	Self clip
Section I	A <sub>1</sub>	60	Only metals	All solid materials	Only metals	All solid materials	Weldable metals, Polymers	Only some metals	All solid materials	All solid materials	Metals with good bending properties
	B <sub>1</sub>	0	4	5	4	5	4	0	5	5	4
	C <sub>1</sub>	0	3	3	3	3	3	1	5	3	3
	D <sub>1</sub>	0	0	5	0	4	4	0	5	4	0
	E <sub>1</sub>	10	3	5	5	3	2	2	1	1	5
Section II	A <sub>2</sub>	10	5	4	5	3	1	2	2	1	5
	B <sub>2</sub>	0	4	4	4	4	3	4	4	4	4
	C <sub>2</sub>	0	5	4	5	2	5	2	5	5	2
	D <sub>2</sub>	0	2	2	3	2	5	2	4	5	2
	E <sub>2</sub>	E <sub>21</sub>	0	4	5	5	5	5	5	4	5
E <sub>22</sub>		0	4	5	5	5	5	5	4	5	4
Section III	A <sub>3</sub>	0	5	5	5	5	2	2	5	5	5
	B <sub>3</sub>	10	5	3	3	3	3	5	3	3	5
	C <sub>3</sub>	0	5	5	5	5	3	1	5	5	5
	D <sub>3</sub>	0	3	3	3	4	5	5	4	4	2
	E <sub>3</sub>	0	4	4	4	4	4	1	5	4	4
Section IV	A <sub>4</sub>	0	3	3	3	5	1	1	3	2	4
	B <sub>4</sub>	10	5	5	5	4	4	3	5	5	5
	C <sub>4</sub>	0	5	5	5	4	2	5	5	5	5
	D <sub>4</sub>	0	4	4	4	4	0	0	0	3	4
<b>Total Points</b>			<b>180</b>	<b>170</b>	<b>180</b>	<b>130</b>	<b>100</b>	<b>120</b>	<b>110</b>	<b>100</b>	<b>200</b>

Table 6

- A<sub>1</sub> Materials  
 B<sub>1</sub> Possibility of joining different materials  
 C<sub>1</sub> Corrosion of material at the joints  
 D<sub>1</sub> Possibility of joining fragile parts  
 E<sub>1</sub> Dependence of joint result on surface quality

- A<sub>2</sub> Pre-processing  
 B<sub>2</sub> Reachability  
 C<sub>2</sub> Dynamic load-resistance  
 D<sub>2</sub> Static Load Resistance  
 E<sub>2</sub> Crush load-resistance  
 E<sub>21</sub> *Shearing stress*  
 E<sub>22</sub> *Head stress*

- A<sub>3</sub> Joining and strength alteration at joining point  
 B<sub>3</sub> Joining consumable required  
 C<sub>3</sub> Heating disadvantages  
 D<sub>3</sub> Tightness  
 E<sub>3</sub> Environmental friendly

- A<sub>4</sub>    Reproducibility
- B<sub>4</sub>    Edges - Burning - Splinters
- C<sub>4</sub>    Professional Skills
- D<sub>4</sub>    Energy consumption

In case 3, the parameters considered (A<sub>1</sub>, E<sub>1</sub>, B<sub>2</sub> and B<sub>4</sub>), have been assigned more significance as compared to other parameters because of the reasons given in table 7 below:

<b>Parameter</b>	<b>Reasons</b>
A <sub>1</sub>	The material selected should be worthy enough to ease out the suitability of other parameters in this case. Moreover the material should provide maximum flexibility in the manufacturing processes employed.
A <sub>2</sub>	It is required so as to make the assembly of various parts of a washing machine feasible and effective.
B <sub>2</sub>	As this product can be produced through unsophisticated technology, the reachability of the joining method should be such that the product can be successfully produced through lean production.
B <sub>4</sub>	As this product involves regular human intervention, hence the joining method concerned should not give rise to any uneven surfaces, which can hamper the portability of the product in normal usage.

**Table 7**

In case 3, which is cupboard, can be handled quite easily by the self-clipping method if some more emphasis are placed on the modern tool technology. Hence, as a second option, clinching and self-pierce riveting can meet the requirements with slight variations.

The parameters besides these, can have better application in some other cases, which depends upon several factors like designing methods used, manufacturing procedures adopted, environmental conditions, customer requirements etc.

## 5 ANALYSIS AND DISCUSSION

After considering applications, advantages, disadvantages and compatibilities of the joining methods, the generated table has been taken into account. The considered parameters are graded and the grading against each method for each parameter is done on the basis of available information and data about the methods. The scale of 5 is used to grade the methods for each parameter; the given grade 5 for any method corresponds to the maximum fulfilment of the specific requirement by the method. Although all the parameters are important to be considered but some parameters carries more importance according to the particular case. Percentage is allotted to these parameters based on the value and consideration they hold for the case. The total points obtained for each method are the sum of the multiplication of the percentage importance and the grade of the suitability.

The method that carries the maximum points is considered as the best joining method. This scaling, grading and selection of joining method is based on this thesis work, available resources, available literature and perception; hence this is not the only optimum choice. Moreover these grades and especially the percent importance of each parameter for the particular cases are considered in this work. These parameters may carry different weightage of importance in some other cases based on the application of the product.

Every method has some comparative advantages and disadvantages that make the selection intricate and the selected method in each case is not the only optimum and best possible choice. Sometimes, there has been a compromise on some parameters while comparing multiple methods with diverse yet superior features; the constructed table provides flexibility to method selection. The analysis of nine different joining methods has been done in the table and can be used while considering other cases.

The analysis of the methods can be extended or altered by changing the parameters according to the constraint.

On the other hand there are some methods in the table that although efficiently applicable, need more research work to be done in order to optimize their implementation. Sometimes it becomes difficult to grade the methods due to the lack of proper perception, which may create irrelevant shortcomings in the selection of the precise joining method.

### **5.1 Sensitive Analysis**

In the present work, the parameters have been given certain importance in percentage, depending upon the available data, references, literature and technical perception. Further the grading of several joining methods has been accomplished on the same basis as in case of parameters; meanwhile it is noticed that the parameters, which have been assigned more importance as compared to others, are the main aspects that make the suitability of the methods better than the others.

Now if the percentage importance of the selected or non-selected parameters is altered, the corresponding modification in the ultimate utility of the method gets influenced. Henceforth whenever the importance assigned to a certain parameter has to be amended, the grading of several methods for the same parameter must be estimated rather manipulated such that the final utility of the method is not affected severely, so that any unexpected results in the final utility of the method may not be obtained.

For the better application of the table, a certain standard (which facilitates the allocation of importance to various parameters) should be finalised and followed. Further research in the development of this table should be undertaken so as to obtain

the optimum allocation of percentage importance to various parameters and eventually obtain the most judicious utility of the joining methods.

In case laser welding is selected as the type of joining method, the bulk production should be sought after so as to compensate for the higher capital cost of lasers as compared to other methods. Although the utility of laser welding is seen to be very near to the mechanical joining methods, the higher cost of investment and running of lasers can be a deciding factor in the selection of the type of joining method, in case the bulk production is not feasible or not requisite.

### **Sensitive analysis for case 1, (Washing Machine)**

The chart 1 illustrates the behaviour of the minimum, the maximum and the mean values of the points obtained for each of the nine joining methods. The percentage importance to each of the nine joining methods was assigned in three sets and for each set the total points obtained were calculated (see appendix 1). Out of these three values, the maximum and minimum values were analysed and their mean value was calculated.

The points obtained for the mean values show the utility of each of the nine joining methods for a certain application (washing machine in case 1). The mean values, of the points obtained, can be useful in the judicious selection of the type of joining method. Also it can be seen that among mechanical joining methods the difference in the mean values is inferior to the difference in the mean values of non-mechanical joining methods. Hence the alteration in the choice of mechanical joining methods can have greater impact on the utility of the method as compared to non-mechanical joining methods.

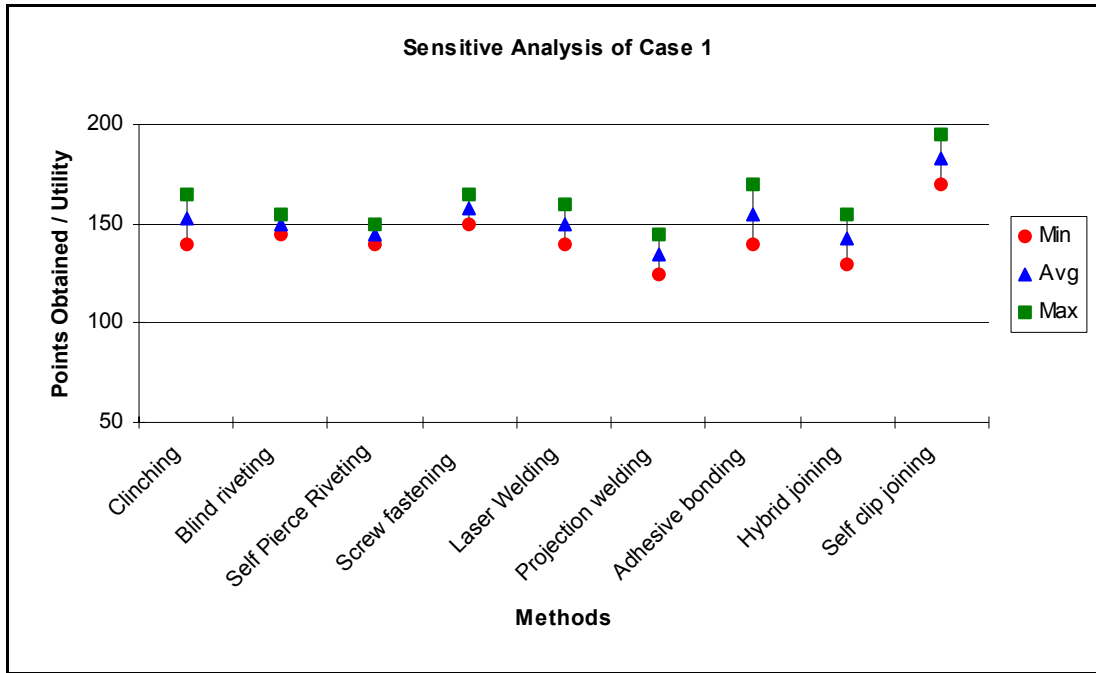


Chart 1 Sensitive Analysis for Case 1

### Sensitive analysis for case 2, (Light Fixture)

The chart 2 illustrates the behaviour of the minimum, the maximum and the mean values of the points obtained for each of the nine joining methods. The percentage importance to each of the nine joining methods was assigned in three sets and for each set the total points obtained were calculated (see appendix 2). Out of these three values, the maximum and minimum values were analysed and their mean value was calculated.

The points obtained for the mean values show the utility of each of the nine joining methods for a certain application (light fixture in case 2). The mean values, of the points obtained, can be useful in the judicious selection of the type of joining method. It can be seen that among the joining methods the difference in the mean values of the utility of clinching, self-pierce riveting and self-clipping is inferior to the difference

in the mean values of other joining methods. Hence the value of utility of the joining method can be the basis of selection of the type of joining method.

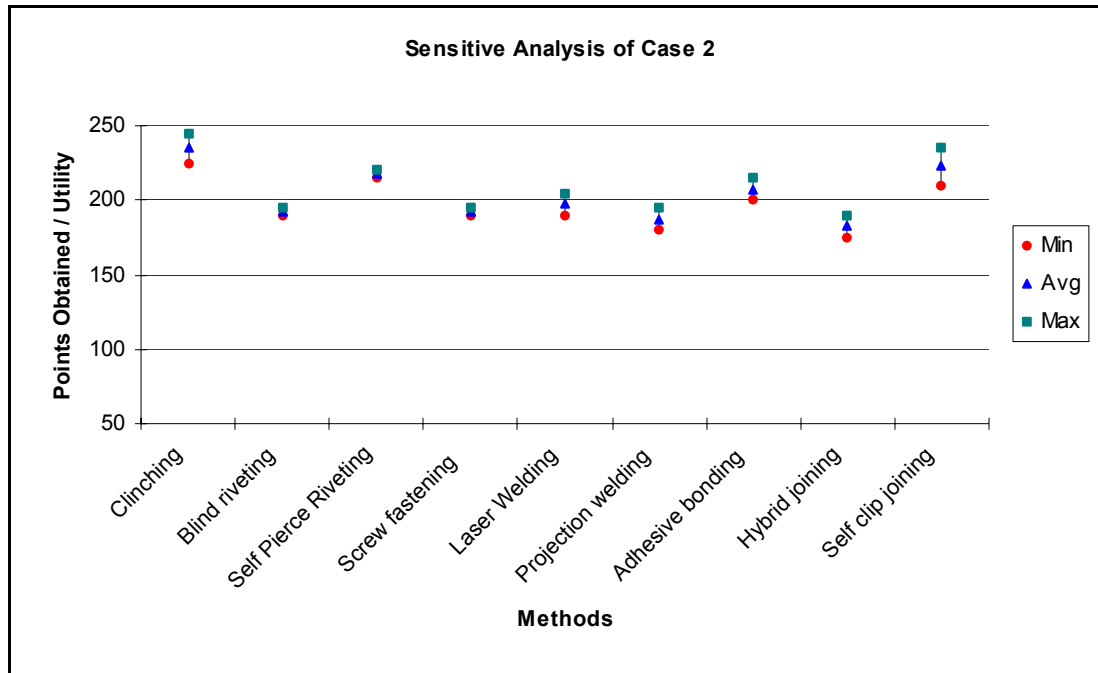


Chart 2 Sensitive Analysis for Case 2

### Sensitive analysis for case 3, (Cupboard)

The chart 3 illustrates the behaviour of the minimum, the maximum and the mean values of the points obtained for each of the nine joining methods. The percentage importance to each of the nine joining methods was assigned in three sets and for each set the total points obtained were calculated (see appendix 3). Out of these three values, the maximum and minimum values were analysed and their mean value was calculated.

The points obtained for the mean values show the utility of each of the nine joining methods for a certain application (cupboard in case 3). The mean values, of the points obtained, can be useful in the judicious selection of the type of joining method. Also it can be seen that among the joining methods like clinching, blind riveting, self-

pierce riveting and self-clip joining the difference in the mean values is inferior to the difference in the mean values of joining methods like laser welding, projection welding, adhesive bonding and hybrid joining. Hence the choice of joining methods in this case can be dependent upon the associated utility.

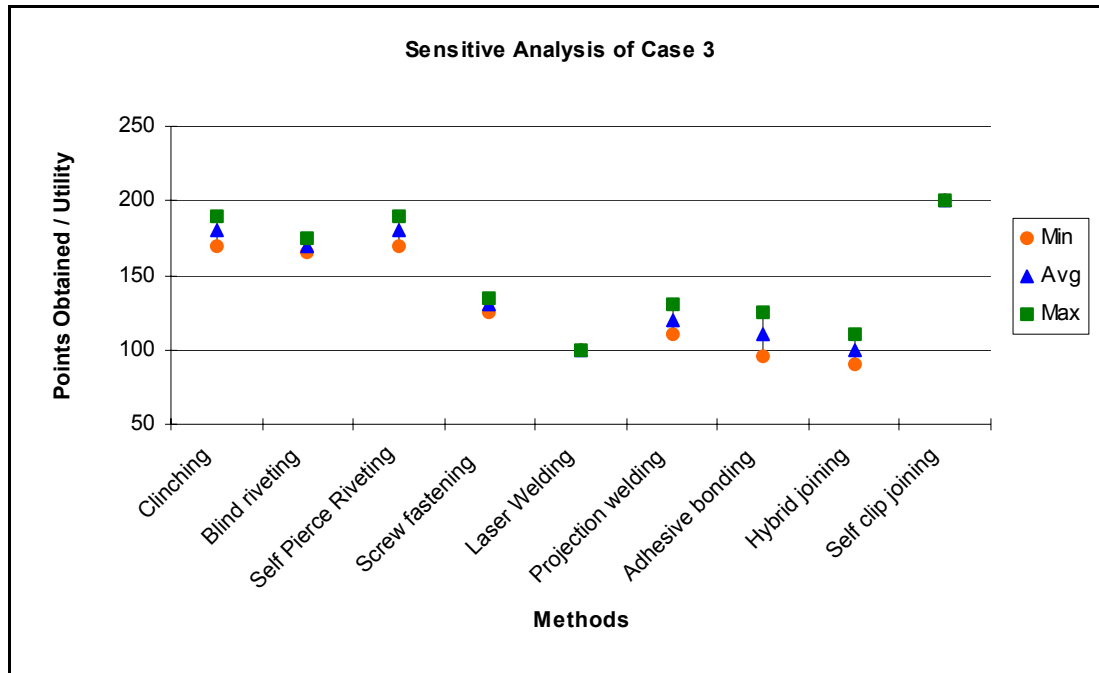


Chart 3 Sensitive Analysis for Case 3

## 5.2 Cost Analysis

In this work several joining methods considered, illustrate different costs of production. It has been noticed that the production cost of mechanical joining methods is much lower than the non-mechanical joining methods. The selection of the joining process depends upon the conditions of application of the product and the requirements of the customer.

For an accustomed application, one of the mechanical joining methods like clinching, blind riveting, self pierce riveting and screw fastening can be selected; all these



joining methods exhibit lower production cost as compared to other non-mechanical joining methods. If the cost of production is the priority of the selection, these mechanical joining methods can serve the purpose; moreover along with the lower cost of production, these joining methods do provide satisfactory results for a vast number of applications.

Further if the precedence has to be given to the high quality of the joint, the selection of joining methods has bigger domain, and the non mechanical joining methods like laser welding, projection welding, adhesive bonding, hybrid joining and self clip joining can also be chosen. These joining methods provide higher quality of the joint as compared to the mechanical joining methods, though they exhibit much higher production costs.

It is also noted that in some cases, the percentage difference in the cost of production between one of the mechanical joining methods and non-mechanical joining methods is more than 50%; for instance the percentage difference between the cost of production of clinching and projection welding is found to be about 70 %, which is quite detrimental for applications where the existing joining method is superseded by a new method. On the other hand if the new joining method, which replaces the existing one, is such that the percentage difference in the cost of production between the two is less than 50% (such as screw fastening and self-clip joint with a difference of about 27%), the choice of the new method can be accepted in certain applications.

In case the bulk production is sought after, the change of joining method can have big impact on the production cost. It is recommended that in such cases when a new joining method supersedes the existing one, the percentage change in the production cost is minimum, for example self-pierce riveting and adhesive bonding, where the percentage difference is 4.80 %. Again the final choice of the type of joining method depends on the requirements of the application and needs of the customer.

The chart 4 shown below displays the relationship between the total production cost of the process and the investment made in the machinery. For different types of joining methods like clinching, blind riveting, self pierce riveting, screw fastening, laser welding, projection welding, adhesive bonding, hybrid joining and self clip joining, the chart can be used to find the corresponding cost (euros/metre) for a certain value of investment (euros).

S. No	Process	No. Of joints /metre	Time Reqd. (sec/joint)	Cycle lead time (sec)	Total process time (sec)	Total process time for 1 metre (sec)	Cost of labour /metre (e/metre)	Energy rate of process (e/hr)	Cost of energy /metre	Machine investment (e)	Cost of machine investment / hr (e/metre)	Reqd. floor area (Sqmetre)
1	<b>Clinching</b>	5	2	4	6	30	0.15	0.5	0.0014	12000	0.0008	2
2	<b>Blind Riveting</b>	5	3	4	7	35	0.175	0.5	0.0021	1000	0.0001	2
3	<b>Self Pierce Riveting</b>	5	2	4	6	30	0.15	0.5	0.0014	12000	0.0008	2
4	<b>Screw Fastening</b>	5	3	4	7	35	0.175	0.5	0.0021	1000	0.0001	1
5	<b>Laser Welding</b>	5	5	4	9	45	0.225	2.5	0.0174	150000	0.0238	25
6	<b>Projection Welding</b>	5	20	0	20	100	0.5	1	0.0278	10000	0.0063	5
7	<b>Adhesive Bonding</b>	1	20	10	30	30	0.15	2	0.0111	8000	0.0010	5
8	<b>Hybrid Joining</b>	3	25	8	33	99	0.495	2	0.0417	10000	0.0048	6
9	<b>Self Clip Joining</b>	5	6	4	10	50	0.25	0.5	0.0042	1200	0.0002	2

S. No	Process	Cost of unit floor area/metre (e/metre)	Tools and Addnl. elements cost /metre (e/mtr)	Monthly Interest (e)	Working Hour interest (e/hr)	Interest per metre (e/metre)	Compensation /hr (e/hr)	Compensation per metre (e/metre)	Unit cost of process (e/ metre)
1	<b>Clinching</b>	0.000027	0.0250	200	0.581	0.005	0.00015	0.000001	<b>0.1820</b>
2	<b>Blind Riveting</b>	0.000040	0.1000	16.67	0.048	0.001	0.00002	0.000000	<b>0.2777</b>
3	<b>Self Pierce Riveting</b>	0.000027	0.0475	200	0.581	0.005	0.00015	0.000001	<b>0.2045</b>
4	<b>Screw Fastening</b>	0.000020	0.0625	16.67	0.048	0.000	0.00002	0.000000	<b>0.2402</b>
5	<b>Laser Welding</b>	0.000832	0.8350	2500	7.267	0.091	0.00476	0.000059	<b>1.1929</b>
6	<b>Projection Welding</b>	0.000666	0.0500	167.7	0.488	0.014	0.00127	0.000035	<b>0.5984</b>
7	<b>Adhesive Bonding</b>	0.000133	0.0500	133.34	0.388	0.003	0.00020	0.000002	<b>0.2155</b>
8	<b>Hybrid Joining</b>	0.000599	0.0300	166.7	0.485	0.014	0.00095	0.000026	<b>0.5854</b>
9	<b>Self Clip Joining</b>	0.000080	0.0750	25	0.073	0.001	0.00005	0.000001	<b>0.3305</b>

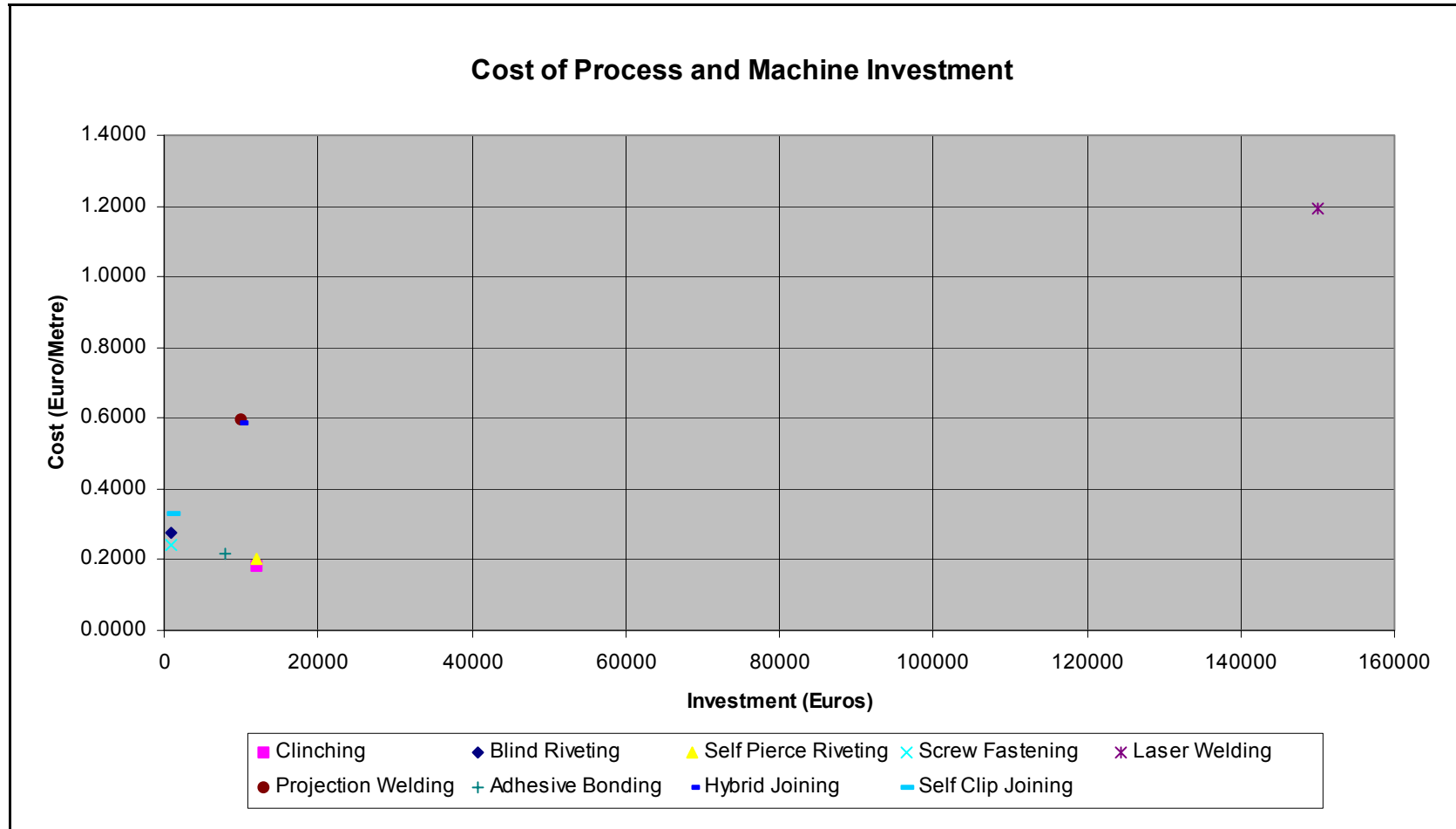


Chart 4 Investment Vs Cost

### **5.3 Analysis for DFMA**

Design for manufacturing and assembly can have various aspects on different types of joining methods. During manufacturing, several circumstances do occur, for which care must be taken during the design process itself. The designer should consider all the aspects of manufacturing, which are likely to happen during the manufacturing process. Similarly the designer must also take care of various problems or circumstances that might be met during the assembly process. If all these aspects are considered during the design process, the manufacturing and assembly processes could be very prosperous, as all the possible bottlenecks can be checked out during design process itself.

It will be thriving if the commencement of DFMA is from the beginning of the manufacturing process, with the design process considered as the first stage of manufacturing. The appropriate manufacturing methods should be distinguished in very early stages so that all aspects related to DFMA can be used judiciously without further needs of redesigns. Along with designer's ability to consider various aspects of manufacturing during design process, some professional teamwork is also needed.

The DFMA is proving beneficial for various sheet-metal processing corporations and ventures. In nearby future, the DFMA approach is bound to be a revelation in the sheet-metal processing industry.

### **5.4 Capacity**

The various types of joining methods exhibit diverse capacities associated with work. A large number of processes require pre and post processes so as to achieve the desired quality and attain the required standards in the joining process. The pre-processes and the post-processes may elevate the manufacturing expenses of the

product and also increase the manufacturing time and intricacy of the process. Although a number of joining methods are associated to several pre-processes and also some post-processes like various types of welding methods, several mechanical and chemical joining methods etc., the method should be flexible and worthy enough to get considered for several joining practices. The capacity of the joining processes should be such that minimum pre-processes or post-processes are needed while maintaining the desired standards.

### **5.5 Appearance**

The appearance of the joint, which is obtained after the termination of the joining process, depends upon a number of factors like properties of the materials used, types of joining methods employed, pre-processing and post-processing, joining consumables used, maintenance of surface quality, environmental conditions etc. The various joining techniques leave different impressions on the final product; in the various phases of assembly the joints should be handled in such a way that the appearance of the concluding joint is not hampered. In general the appearance of the joint rather the acceptance of the joint depends upon the requirements of the customer, which could be variable for diverse circumstances.

## 6 CONCLUSION

The applicability of the different joining methods for each of the selected cases has been studied and the conclusions obtained are listed below:

- The tables can be used for the estimation of various joining methods for each of the selected cases with an amalgamation of various joining methods and the corresponding advantages.
- The tables display the percentage applicability or utility of various joining methods for different cases selected, which is based on the technical thinking and maturity of the writer. This might be found dissimilar according to the perception and approach made in future.
- It has, in some cases, been found difficult to grade the various joining methods in accordance to several parameters and concerned characteristics involved.
- As stated in sensitive analysis, the percentage importance assigned to the various types of joining methods is mainly responsible for selection of the joining method and the effect of this percentage allocation overtakes the contribution of several parameters and also dominates the final utility of the method.
- As discussed in cost analysis, the replacement of the existing type of joining method with a new method depends upon the feasibility of the process and requirements of the customer.

- The design for manufacturing and assembly (DFMA) should be implemented in a company right from the beginning of the design process. Also DFMA is a great tool to break the wall between design and manufacturing and provide smoothness and flexibility to the manufacturing process.
- The capacity of the joining method should be able enough to maintain the desired quality and standard with minimum pre-process and post-process treatments, so as to make the joining method effective and economical.
- The appearance of the joint depends on the type of joining method used and various process parameters associated. The acceptance of the appearance of the joint has no rules as such and depends on the fields of application and needs of the customer.
- The future of this work lies with further assessment of various joining methods and the parameters concerned. The parameters can influence the properties of several joining methods, and the degree of influence can depend on the applications concerned.



## REFERENCES

- [1] Technical discussion with Prof. Juha.P.Varis on Monday 1.October, 2004
- [2] Mahmoud M. Farag; Materials and Process Selection in Engineering; ISBN 0-85334-824-3; pages 27...35, 66...88, 180...189
- [3] Daniel Sipper and Robert L. Bulfin, Jr. Production: Planning, Control, and Integration. The McGraw-Hill companies, Inc. ISBN 0-07-057682-3; pages 25...29, 34...40, 45...55
- [4] F.AA Crane and J A Charles; Selection and Use of Engineering Materials; ISBN 0-408-10858-4 and 0-408-10859-2; pages 08...13, 17...20
- [5] [Boothroyd Dewhurst Exploring Costs and Increasing Profits www-pages] [Retrieved March 22, 2005] From <http://www.dfma.com/>
- [6] [DFMA to RP www-pages] [Retrieved March 22, 2005] From <http://www.memagazine.org/backissues/september99/features/dfma/dfma.html>
- [7] Mikael Ollikainen, Research Report, DFMA- aspects of fabricating front panels for telecommunication cabinet plug-in units and use in similar product types. ISBN 951-764-534-1; pages 16...20
- [8] [TWI world centre for materials joining technology]. [Clinching www-page]. [Retrieved November 19, 2005] From [http://www.twi.co.uk/j32k/protected/band\\_3/kschjg001.html](http://www.twi.co.uk/j32k/protected/band_3/kschjg001.html)

- [9] [Clinching Image www-pages] [Retrieved March 21, 2005] From [http://www.twi.co.uk/j32k/unprotected/band\\_1/c1093.html](http://www.twi.co.uk/j32k/unprotected/band_1/c1093.html)
- [10] Roy. A. Lindberg: Welding and other joining processes, Library of Congress in Publication Data, ISBN 0-205-05000-X; pages 195...227
- [11] [Assembly Magazine www-pages]. [Retrieved March 14, 2005] From [http://www.assemblymag.com/CDA/ArticleInformation/features/BNP\\_\\_Features\\_\\_Item/0,6493,100045,00.html](http://www.assemblymag.com/CDA/ArticleInformation/features/BNP__Features__Item/0,6493,100045,00.html)
- [12] [Dehwaind Forming www-pages]. [Retrieved March 14 2005] From [http://www.daehwaind.com/products/blind\\_method.htm](http://www.daehwaind.com/products/blind_method.htm)
- [13] [Top Screw Metal Corporation www-pages]. [Retrieved March 15, 2005] From <http://www.topscrew.com.tw/e/047237159/next-01e.htm>
- [14] [Assembly Magazine www-pages]. [Retrieved March 03, 2005] From <http://www.assemblymag.com/CDA/ArticleInformation/features>
- [15] [Boellhoff Riveting www-pages] [Retrieved March 03, 2005] From [http://www.boellhoff.de/web/germany/en/web.nsf/HTML/produkte\\_rivset\\_dieidee.html](http://www.boellhoff.de/web/germany/en/web.nsf/HTML/produkte_rivset_dieidee.html)
- [16] [ATC Riveting www-pages] [Retrieved March 05, 2005] From <http://www.atcrivet.com/pics/sprivet2.gif>
- [17] [TWI world centre for materials joining technology] [Retrieved November 05, 2005] From [http://www.twi.co.uk/j32k/protected/band\\_3/kschjg002.html](http://www.twi.co.uk/j32k/protected/band_3/kschjg002.html)
- [18] [Styron Asia Limited www-pages] [Retrieved February 11, 2005] From <http://www.dow.com/sal/design/guide/fasteners.htm>

- [19] [Mechanical Components Course Notes for Mech 251 Peter Ostafichuk www-pages] [Retrieved March 10, 2005] From <http://www.mech.ubc.ca/~mech251/Mechanical1.pdf>
- [20] [Penn Fast Fastening Products www-pages] [Retrieved March 01, 2005] From [http://www.pennfast.com/fastening\\_products/pdf/Handbook.pdf](http://www.pennfast.com/fastening_products/pdf/Handbook.pdf)
- [21] [White Sell Screws www-pages] [Retrieved March 05, 2005] From <http://www.whitesell.ca/screws.htm>
- [22] [TWI world centre for materials joining technology]. [Laser welding www-page]. [Retrieved January 05, 2005]. From <http://www.twi.co.uk>
- [23] [Laser Welding Image www-pages] [Retrieved January 18, 2005] From [http://www.machinedesign.com/Content/Issue/10625/laser\\_3.jpg](http://www.machinedesign.com/Content/Issue/10625/laser_3.jpg)
- [24] [Preco Associated Companies www-pages] [Retrieved November 22, 2004] From <http://www.precolaser.com/metal.htm>
- [25] [Medar Welding Concepts www-pages] [Retrieved March 15, 2005]. From [http://www.medar.com/welding\\_concepts/projectionweld.html](http://www.medar.com/welding_concepts/projectionweld.html)
- [26] [TWI world center for materials joining technology] [Retrieved March 15, 2005] From [http://www.twi.co.uk/j32k/protected/band\\_3/kssaw003.html](http://www.twi.co.uk/j32k/protected/band_3/kssaw003.html)
- [27] [Designinsite Welding www-pages] [Retrieved March 15, 2005]. From <http://www.designinsite.dk/htmsider/pb0024.htm>
- [28] Robert D. Adams; Structural Adhesive Joints in Engineering, British Library Cataloguing in Publication Data, ISBN0-85334-263-6; pages 5...15, 271...282

- [29] [Adhesive Bonding Images www-pages] [Retrieved November 22, 2004].  
From <http://www.agcincorporated.com/manufaca.htm>
- [30] [Structural Adhesives, Huntsman's user guide to adhesives www-pages]  
[Retrieved March 10, 2005] From [http://www.huntsman.com/structural-adhesives/Media/usersGuide\\_Uk.pdf](http://www.huntsman.com/structural-adhesives/Media/usersGuide_Uk.pdf)
- [31] [U.S. Patent, Online Data Base] [Retrieved February 07, 2005] From  
<http://www.uspto.gov/patft/index.html>
- [32] [U.S. Patent, Online Data Base] [Retrieved February 09, 2005] From  
<http://www.uspto.gov/patft/index.html>
- [33] [Thomas Net News Room] [Retrieved January 11, 2005]  
<http://news.thomasnet.com/fullstory/19827>
- [34] Thomas T. Woodson, Introduction to Engineering Design, ISBN 07-071760-5,  
pages 109...117, 239...255
- [35] [Global Spec. The Engineering Search Engine www-pages] [Retrieved March  
01, 2005] From <http://sheet-metal-fabrication.globalspec.com/>
- [36] [U.S. Patent, online data base] [Retrieved February 22, 2005] From  
<http://www.uspto.gov/patft/index.html>
- [37] Myron L. Begeman and B. H. Amstead; Manufacturing Process, ISBN 68-  
30907-471062405; pages 288...290, 310...322
- [38] [Penton Machine Design www-pages] [Retrieved March 01, 2005] From  
<http://www.machinedesign.com/Content/Issue/10640>

- [39] High Productivity Joining Process, 7 International Aachen Welding Conference 2001; ISBN 3-8265-8759-6; pages 655...670, 637...654
- [40] [Thomas Net Industrial News Room www-pages] [Retrieved March 01, 2005]  
From <http://news.thomasnet.com/index.html>
- [41] James G. Balla, Hand Book of Product Design for Manufacturing, ISBN 0-07-007130-6, pages 3.1...3.17, 3.32...3.36
- [42] Robert O. Parmley, P.E, Standard Hand Book of Fastening and Joining, ISBN 0-07-048511-9, pages 12.1-12.20
- [43] [TWI world centre for materials joining technology] [Retrieved March 01, 2005]  
From [http://www.twi.co.uk/j32k/unprotected/band\\_1/research\\_core2004-06.html](http://www.twi.co.uk/j32k/unprotected/band_1/research_core2004-06.html)

# **APPENDICES**

**Appendix A**

**Appendix B**

**Appendix C**

**Sensitive Analysis of Case 1**

**Sensitive Analysis of Case 2**

**Sensitive Analysis of Case 3**

Case 1, Washing Machine

Parameters	Ex 1st	Ex 2nd	Ex 3rd	Clinching	Res 1st	Res 2nd	Res 3rd
B <sub>1</sub>	0	0	0	4	0	0	0
C <sub>1</sub>	10	5	15	3	30	15	45
D <sub>1</sub>	0	0	0	0	0	0	0
E <sub>1</sub>	0	0	0	3	0	0	0
A <sub>2</sub>	5	10	5	5	25	50	25
B <sub>2</sub>	0	0	0	4	0	0	0
C <sub>2</sub>	0	0	0	5	0	0	0
D <sub>2</sub>	10	5	10	2	20	10	20
E <sub>2</sub>	E <sub>21</sub>	0	0	0	4	0	0
	E <sub>22</sub>	0	0	0	4	0	0
A <sub>3</sub>	0	0	0	5	0	0	0
B <sub>3</sub>	5	10	10	5	25	50	50
C <sub>3</sub>	0	0	0	5	0	0	0
D <sub>3</sub>	10	10	5	3	30	30	15
E <sub>3</sub>	0	0	0	4	0	0	0
A <sub>4</sub>	10	10	5	1	10	10	5
B <sub>4</sub>	0	0	0	5	0	0	0
C <sub>4</sub>	0	0	0	5	0	0	0
D <sub>4</sub>	0	0	0	4	0	0	0
<b>Total Points</b>					<b>140</b>	<b>165</b>	<b>160</b>

Parameters	Ex 1st	Ex 2nd	Ex 3rd	Blind Riveting	Res 1st	Res 2nd	Res 3rd
B <sub>1</sub>	0	0	0	5	0	0	0
C <sub>1</sub>	10	5	15	3	30	15	45
D <sub>1</sub>	0	0	0	5	0	0	0
E <sub>1</sub>	0	0	0	5	0	0	0
A <sub>2</sub>	5	10	5	4	20	40	20
B <sub>2</sub>	0	0	0	4	0	0	0
C <sub>2</sub>	0	0	0	4	0	0	0
D <sub>2</sub>	10	5	10	2	20	10	20
E <sub>2</sub>	E <sub>21</sub>	0	0	0	5	0	0
	E <sub>22</sub>	0	0	0	5	0	0
A <sub>3</sub>	0	0	0	5	0	0	0
B <sub>3</sub>	5	10	10	3	15	30	30
C <sub>3</sub>	0	0	0	5	0	0	0
D <sub>3</sub>	10	10	5	3	30	30	15
E <sub>3</sub>	0	0	0	4	0	0	0
A <sub>4</sub>	10	10	5	3	30	30	15
B <sub>4</sub>	0	0	0	5	0	0	0
C <sub>4</sub>	0	0	0	5	0	0	0
D <sub>4</sub>	0	0	0	4	0	0	0
<b>Total Points</b>					<b>145</b>	<b>155</b>	<b>145</b>

Parameters	Ex 1st	Ex 2nd	Ex 3rd	Self-Pierce Riveting	Res 1st	Res 2nd	Res 3rd
B <sub>1</sub>	0	0	0	4	0	0	0
C <sub>1</sub>	10	5	15	3	30	15	45
D <sub>1</sub>	0	0	0	0	0	0	0
E <sub>1</sub>	0	0	0	5	0	0	0
A <sub>2</sub>	5	10	5	5	25	50	25
B <sub>2</sub>	0	0	0	4	0	0	0
C <sub>2</sub>	0	0	0	5	0	0	0
D <sub>2</sub>	10	5	10	3	30	15	30
E <sub>2</sub>	E <sub>21</sub>	0	0	0	5	0	0
	E <sub>22</sub>	0	0	0	5	0	0
A <sub>3</sub>	0	0	0	5	0	0	0
B <sub>3</sub>	5	10	10	3	15	30	30
C <sub>3</sub>	0	0	0	5	0	0	0
D <sub>3</sub>	10	10	5	3	30	30	15
E <sub>3</sub>	0	0	0	4	0	0	0
A <sub>4</sub>	10	10	5	1	10	10	5
B <sub>4</sub>	0	0	0	5	0	0	0
C <sub>4</sub>	0	0	0	5	0	0	0
D <sub>4</sub>	0	0	0	4	0	0	0
<b>Total Points</b>					<b>140</b>	<b>150</b>	<b>150</b>

Parameters	Ex 1st	Ex 2nd	Ex 3rd	Screw Fastening	Res 1st	Res 2nd	Res 3rd
B <sub>1</sub>	0	0	0	5	0	0	0
C <sub>1</sub>	10	5	15	3	30	15	45
D <sub>1</sub>	0	0	0	4	0	0	0
E <sub>1</sub>	0	0	0	3	0	0	0
A <sub>2</sub>	5	10	5	3	15	30	15
B <sub>2</sub>	0	0	0	4	0	0	0
C <sub>2</sub>	0	0	0	2	0	0	0
D <sub>2</sub>	10	5	10	2	20	10	20
E <sub>2</sub>	E <sub>21</sub>	0	0	0	5	0	0
	E <sub>22</sub>	0	0	0	5	0	0
A <sub>3</sub>	0	0	0	5	0	0	0
B <sub>3</sub>	5	10	10	3	15	30	30
C <sub>3</sub>	0	0	0	5	0	0	0
D <sub>3</sub>	10	10	5	3	30	30	15
E <sub>3</sub>	0	0	0	4	0	0	0
A <sub>4</sub>	10	10	5	5	50	50	25
B <sub>4</sub>	0	0	0	3	0	0	0
C <sub>4</sub>	0	0	0	5	0	0	0
D <sub>4</sub>	0	0	0	4	0	0	0
<b>Total Points</b>					<b>160</b>	<b>165</b>	<b>150</b>

Case 1, Washing Machine

Parameters	Ex 1st	Ex 2nd	Ex 3rd	Laser Welding	Res 1st	Res 2nd	Res 3rd
B <sub>1</sub>	0	0	0	4	0	0	0
C <sub>1</sub>	10	5	15	3	30	15	45
D <sub>1</sub>	0	0	0	4	0	0	0
E <sub>1</sub>	0	0	0	0	0	0	0
A <sub>2</sub>	5	10	5	1	5	10	5
B <sub>2</sub>	0	0	0	3	0	0	0
C <sub>2</sub>	0	0	0	5	0	0	0
D <sub>2</sub>	10	5	10	5	50	25	50
E <sub>2</sub>	E <sub>21</sub>	0	0	0	5	0	0
	E <sub>22</sub>	0	0	0	5	0	0
A <sub>3</sub>	0	0	0	2	0	0	0
B <sub>3</sub>	5	10	10	3	15	30	30
C <sub>3</sub>	0	0	0	3	0	0	0
D <sub>3</sub>	10	10	5	5	50	50	25
E <sub>3</sub>	0	0	0	4	0	0	0
A <sub>4</sub>	10	10	5	1	10	10	5
B <sub>4</sub>	0	0	0	5	0	0	0
C <sub>4</sub>	0	0	0	2	0	0	0
D <sub>4</sub>	0	0	0	0	0	0	0
<b>Total Points</b>					<b>160</b>	<b>140</b>	<b>160</b>

Parameters	Ex 1st	Ex 2nd	Ex 3rd	Projection Welding	Res 1st	Res 2nd	Res 3rd
B <sub>1</sub>	0	0	0	0	0	0	0
C <sub>1</sub>	10	5	15	1	10	5	15
D <sub>1</sub>	0	0	0	0	0	0	0
E <sub>1</sub>	0	0	0	1	0	0	0
A <sub>2</sub>	5	10	5	2	10	20	10
B <sub>2</sub>	0	0	0	4	0	0	0
C <sub>2</sub>	0	0	0	2	0	0	0
D <sub>2</sub>	10	5	10	2	20	10	20
E <sub>2</sub>	E <sub>21</sub>	0	0	0	5	0	0
	E <sub>22</sub>	0	0	0	5	0	0
A <sub>3</sub>	0	0	0	2	0	0	0
B <sub>3</sub>	5	10	10	5	25	50	50
C <sub>3</sub>	0	0	0	1	0	0	0
D <sub>3</sub>	10	10	5	5	50	50	25
E <sub>3</sub>	0	0	0	1	0	0	0
A <sub>4</sub>	10	10	5	1	10	10	5
B <sub>4</sub>	0	0	0	3	0	0	0
C <sub>4</sub>	0	0	0	5	0	0	0
D <sub>4</sub>	0	0	0	0	0	0	0
<b>Total Points</b>					<b>125</b>	<b>145</b>	<b>125</b>

Parameters	Ex 1st	Ex 2nd	Ex 3rd	Adhesive Bonding	Res 1st	Res 2nd	Res 3rd
B <sub>1</sub>	0	0	0	5	0	0	0
C <sub>1</sub>	10	5	15	5	50	25	75
D <sub>1</sub>	0	0	0	5	0	0	0
E <sub>1</sub>	0	0	0	0	0	0	0
A <sub>2</sub>	5	10	5	2	10	20	10
B <sub>2</sub>	0	0	0	4	0	0	0
C <sub>2</sub>	0	0	0	5	0	0	0
D <sub>2</sub>	10	5	10	3	30	15	30
E <sub>2</sub>	E <sub>21</sub>	0	0	0	4	0	0
	E <sub>22</sub>	0	0	0	4	0	0
A <sub>3</sub>	0	0	0	5	0	0	0
B <sub>3</sub>	5	10	10	3	15	30	30
C <sub>3</sub>	0	0	0	5	0	0	0
D <sub>3</sub>	10	10	5	4	40	40	20
E <sub>3</sub>	0	0	0	5	0	0	0
A <sub>4</sub>	10	10	5	1	10	10	5
B <sub>4</sub>	0	0	0	5	0	0	0
C <sub>4</sub>	0	0	0	5	0	0	0
D <sub>4</sub>	0	0	0	0	0	0	0
<b>Total Points</b>					<b>155</b>	<b>140</b>	<b>170</b>

Parameters	Ex 1st	Ex 2nd	Ex 3rd	Hybrid Joining	Res 1st	Res 2nd	Res 3rd
B <sub>1</sub>	0	0	0	5	0	0	0
C <sub>1</sub>	10	5	15	3	30	15	45
D <sub>1</sub>	0	0	0	4	0	0	0
E <sub>1</sub>	0	0	0	1	0	0	0
A <sub>2</sub>	5	10	5	1	5	10	5
B <sub>2</sub>	0	0	0	4	0	0	0
C <sub>2</sub>	0	0	0	5	0	0	0
D <sub>2</sub>	10	5	10	5	50	25	50
E <sub>2</sub>	E <sub>21</sub>	0	0	0	5	0	0
	E <sub>22</sub>	0	0	0	5	0	0
A <sub>3</sub>	0	0	0	5	0	0	0
B <sub>3</sub>	5	10	10	3	15	30	30
C <sub>3</sub>	0	0	0	5	0	0	0
D <sub>3</sub>	10	10	5	4	40	40	20
E <sub>3</sub>	0	0	0	4	0	0	0
A <sub>4</sub>	10	10	5	1	10	10	5
B <sub>4</sub>	0	0	0	5	0	0	0
C <sub>4</sub>	0	0	0	5	0	0	0
D <sub>4</sub>	0	0	0	3	0	0	0
<b>Total Points</b>					<b>150</b>	<b>130</b>	<b>155</b>



Case 1, Washing Machine

Parameters	Ex 1st	Ex 2nd	Ex 3rd	Self-Clip	Res 1st	Res 2nd	Res 3rd
B <sub>1</sub>	0	0	0	4	0	0	0
C <sub>1</sub>	10	5	15	3	30	15	45
D <sub>1</sub>	0	0	0	0	0	0	0
E <sub>1</sub>	0	0	0	5	0	0	0
A <sub>2</sub>	5	10	5	5	25	50	25
B <sub>2</sub>	0	0	0	4	0	0	0
C <sub>2</sub>	0	0	0	2	0	0	0
D <sub>2</sub>	10	5	10	2	20	10	20
E <sub>2</sub>	E <sub>21</sub>	0	0	4	0	0	0
	E <sub>22</sub>	0	0	4	0	0	0
A <sub>3</sub>	0	0	0	5	0	0	0
B <sub>3</sub>	5	10	10	5	25	50	50
C <sub>3</sub>	0	0	0	5	0	0	0
D <sub>3</sub>	10	10	5	2	20	20	10
E <sub>3</sub>	0	0	0	4	0	0	0
A <sub>4</sub>	10	10	5	5	50	50	25
B <sub>4</sub>	0	0	0	5	0	0	0
C <sub>4</sub>	0	0	0	5	0	0	0
D <sub>4</sub>	0	0	0	4	0	0	0
<b>Total Points</b>					<b>170</b>	<b>195</b>	<b>175</b>

Case 2, Light Fixture

Parameters	Ex 1st	Ex 2nd	Ex 3rd	Clinching	Res 1st	Res 2nd	Res 3rd
B <sub>1</sub>	0	0	0	4	0	0	0
C <sub>1</sub>	15	10	10	3	45	30	30
D <sub>1</sub>	0	0	0	0	0	0	0
E <sub>1</sub>	0	0	0	3	0	0	0
A <sub>2</sub>	10	15	10	5	50	75	50
B <sub>2</sub>	0	0	0	4	0	0	0
C <sub>2</sub>	0	0	0	5	0	0	0
D <sub>2</sub>	0	0	0	2	0	0	0
E <sub>2</sub>	E <sub>21</sub>	0	0	4	0	0	0
	E <sub>22</sub>	0	0	4	0	0	0
A <sub>3</sub>	0	0	0	5	0	0	0
B <sub>3</sub>	5	10	15	5	25	50	75
C <sub>3</sub>	0	0	0	5	0	0	0
D <sub>3</sub>	15	15	10	3	45	45	30
E <sub>3</sub>	15	10	15	4	60	40	60
A <sub>4</sub>	0	0	0	3	0	0	0
B <sub>4</sub>	0	0	0	5	0	0	0
C <sub>4</sub>	0	0	0	5	0	0	0
D <sub>4</sub>	0	0	0	4	0	0	0
<b>Total Points</b>					<b>225</b>	<b>240</b>	<b>245</b>

Parameters	Ex 1st	Ex 2nd	Ex 3rd	Blind Riveting	Res 1st	Res 2nd	Res 3rd
B <sub>1</sub>	0	0	0	5	0	0	0
C <sub>1</sub>	15	10	10	3	45	30	30
D <sub>1</sub>	0	0	0	5	0	0	0
E <sub>1</sub>	0	0	0	5	0	0	0
A <sub>2</sub>	10	15	10	3	30	45	30
B <sub>2</sub>	0	0	0	4	0	0	0
C <sub>2</sub>	0	0	0	4	0	0	0
D <sub>2</sub>	0	0	0	2	0	0	0
E <sub>2</sub>	E <sub>21</sub>	0	0	5	0	0	0
	E <sub>22</sub>	0	0	5	0	0	0
A <sub>3</sub>	0	0	0	5	0	0	0
B <sub>3</sub>	5	10	15	3	15	30	45
C <sub>3</sub>	0	0	0	5	0	0	0
D <sub>3</sub>	15	15	10	3	45	45	30
E <sub>3</sub>	15	10	15	4	60	40	60
A <sub>4</sub>	0	0	0	4	0	0	0
B <sub>4</sub>	0	0	0	5	0	0	0
C <sub>4</sub>	0	0	0	5	0	0	0
D <sub>4</sub>	0	0	0	4	0	0	0
<b>Total Points</b>					<b>195</b>	<b>190</b>	<b>195</b>

Parameters	Ex 1st	Ex 2nd	Ex 3rd	Self Pierce Riveting	Res 1st	Res 2nd	Res 3rd
B <sub>1</sub>		0	0		0	0	0
C <sub>1</sub>	15	10	10	3	45	30	30
D <sub>1</sub>		0	0		0	0	0
E <sub>1</sub>		0	0		0	0	0
A <sub>2</sub>		15	10		50	75	50
B <sub>2</sub>	0	0	0	4	0	0	0
C <sub>2</sub>		0	0	5	0	0	0
D <sub>2</sub>		0	0	3	0	0	0
E <sub>2</sub>	E <sub>21</sub>		0	5	0	0	0
	E <sub>22</sub>		0	5	0	0	0
A <sub>3</sub>		0	0	5	0	0	0
B <sub>3</sub>		10	15	3	15	30	45
C <sub>3</sub>		0	0	5	0	0	0
D <sub>3</sub>		15	10	3	45	45	30
E <sub>3</sub>		10	15	4	60	40	60
A <sub>4</sub>		0	0	1	0	0	0
B <sub>4</sub>		0	0	5	0	0	0
C <sub>4</sub>		0	0	5	0	0	0
D <sub>4</sub>		0	0	4	0	0	0
<b>Total Points</b>					<b>215</b>	<b>220</b>	<b>215</b>

Parameters	Ex 1st	Ex 2nd	Ex 3rd	Screw Fastening	Res 1st	Res 2nd	Res 3rd
B <sub>1</sub>		0	0		0	0	0
C <sub>1</sub>	15	10	10	3	45	30	30
D <sub>1</sub>		0	0		0	0	0
E <sub>1</sub>		0	0		0	0	0
A <sub>2</sub>		15	10		30	45	30
B <sub>2</sub>	0	0	0	4	0	0	0
C <sub>2</sub>		0	0		0	0	0
D <sub>2</sub>		0	0		0	0	0
E <sub>2</sub>	E <sub>21</sub>		0		0	0	0
	E <sub>22</sub>		0		0	0	0
A <sub>3</sub>		0	0		0	0	0
B <sub>3</sub>		10	15	3	15	30	45
C <sub>3</sub>		0	0		0	0	0
D <sub>3</sub>		15	10		45	45	30
E <sub>3</sub>		10	15		60	40	60
A <sub>4</sub>		0	0		0	0	0
B <sub>4</sub>		0	0		0	0	0
C <sub>4</sub>		0	0		0	0	0
D <sub>4</sub>		0	0		0	0	0
<b>Total Points</b>					<b>195</b>	<b>190</b>	<b>195</b>

Case 2, Light Fixture

Parameters	Ex 1st	Ex 2nd	Ex 3rd	Laser Welding	Res 1st	Res 2nd	Res 3rd
B <sub>1</sub>	0	0	0	4	0	0	0
C <sub>1</sub>	15	10	10	3	45	30	30
D <sub>1</sub>	0	0	0	4	0	0	0
E <sub>1</sub>	0	0	0	0	0	0	0
A <sub>2</sub>	10	15	10	1	10	15	10
B <sub>2</sub>	0	0	0	3	0	0	0
C <sub>2</sub>	0	0	0	5	0	0	0
D <sub>2</sub>	0	0	0	5	0	0	0
E <sub>2</sub>	E <sub>21</sub>	0	0	5	0	0	0
	E <sub>22</sub>	0	0	5	0	0	0
A <sub>3</sub>	0	0	0	2	0	0	0
B <sub>3</sub>	5	10	15	3	15	30	45
C <sub>3</sub>	0	0	0	3	0	0	0
D <sub>3</sub>	15	15	10	5	75	75	50
E <sub>3</sub>	15	10	15	4	60	40	60
A <sub>4</sub>	0	0	0	1	0	0	0
B <sub>4</sub>	0	0	0	5	0	0	0
C <sub>4</sub>	0	0	0	2	0	0	0
D <sub>4</sub>	0	0	0	0	0	0	0
<b>Total Points</b>					<b>205</b>	<b>190</b>	<b>195</b>

Parameters	Ex 1st	Ex 2nd	Ex 3rd	Projection Welding	Res 1st	Res 2nd	Res 3rd
B <sub>1</sub>	0	0	0	0	0	0	0
C <sub>1</sub>	15	10	10	2	30	20	20
D <sub>1</sub>	0	0	0	0	0	0	0
E <sub>1</sub>	0	0	0	1	0	0	0
A <sub>2</sub>	10	15	10	2	20	30	20
B <sub>2</sub>	0	0	0	4	0	0	0
C <sub>2</sub>	0	0	0	2	0	0	0
D <sub>2</sub>	0	0	0	2	0	0	0
E <sub>2</sub>	E <sub>21</sub>	0	0	5	0	0	0
	E <sub>22</sub>	0	0	5	0	0	0
A <sub>3</sub>	0	0	0	2	0	0	0
B <sub>3</sub>	5	10	15	5	25	50	75
C <sub>3</sub>	0	0	0	1	0	0	0
D <sub>3</sub>	15	15	10	5	75	75	50
E <sub>3</sub>	15	10	15	2	30	20	30
A <sub>4</sub>	0	0	0	1	0	0	0
B <sub>4</sub>	0	0	0	3	0	0	0
C <sub>4</sub>	0	0	0	5	0	0	0
D <sub>4</sub>	0	0	0	0	0	0	0
<b>Total Points</b>					<b>180</b>	<b>195</b>	<b>195</b>

Parameters	Ex 1st	Ex 2nd	Ex 3rd	Adhesive Bonding	Res 1st	Res 2nd	Res 3rd
B <sub>1</sub>		0	0	5	0	0	0
C <sub>1</sub>	15	10	10	5	75	50	50
D <sub>1</sub>		0	0	5	0	0	0
E <sub>1</sub>		0	0	0	0	0	0
A <sub>2</sub>		15	10		20	30	20
B <sub>2</sub>	0	0	0	4	0	0	0
C <sub>2</sub>		0	0		0	0	0
D <sub>2</sub>		0	0		0	0	0
E <sub>2</sub>	E <sub>21</sub>		0		0	0	0
	E <sub>22</sub>		0		0	0	0
A <sub>3</sub>		0	0		0	0	0
B <sub>3</sub>		10	15	3	15	30	45
C <sub>3</sub>		0	0		0	0	0
D <sub>3</sub>		15	10		60	60	40
E <sub>3</sub>		10	15		45	30	45
A <sub>4</sub>		0	0		0	0	0
B <sub>4</sub>		0	0		0	0	0
C <sub>4</sub>		0	0		0	0	0
D <sub>4</sub>		0	0		0	0	0
<b>Total Points</b>					<b>215</b>	<b>200</b>	<b>200</b>

Parameters	Ex 1st	Ex 2nd	Ex 3rd	Hybrid Joining	Res 1st	Res 2nd	Res 3rd
B <sub>1</sub>		0	0	5	0	0	0
C <sub>1</sub>	15	10	10	3	45	30	30
D <sub>1</sub>		0	0	4	0	0	0
E <sub>1</sub>		0	0	1	0	0	0
A <sub>2</sub>		15	10	1	10	15	10
B <sub>2</sub>	0	0	0	4	0	0	0
C <sub>2</sub>		0	0	5	0	0	0
D <sub>2</sub>		0	0	5	0	0	0
E <sub>2</sub>	E <sub>21</sub>		0	5	0	0	0
	E <sub>22</sub>		0	5	0	0	0
A <sub>3</sub>		0	0	5	0	0	0
B <sub>3</sub>		10	15	3	15	30	45
C <sub>3</sub>		0	0	5	0	0	0
D <sub>3</sub>		15	10	4	60	60	40
E <sub>3</sub>		10	15	4	60	40	60
A <sub>4</sub>		0	0	2	0	0	0
B <sub>4</sub>		0	0	5	0	0	0
C <sub>4</sub>		0	0	5	0	0	0
D <sub>4</sub>		0	0	3	0	0	0
<b>Total Points</b>					<b>190</b>	<b>175</b>	<b>185</b>

Case 2, Light Fixture

Parameters	Ex	Ex	Ex	Self-Clip	Res	Res	Res
	1st	2nd	3rd		1st	2nd	3rd
B <sub>1</sub>	0	0	0	4	0	0	0
C <sub>1</sub>	15	10	10	3	45	30	30
D <sub>1</sub>	0	0	0	0	0	0	0
E <sub>1</sub>	0	0	0	5	0	0	0
A <sub>2</sub>	10	15	10	5	50	75	50
B <sub>2</sub>	0	0	0	4	0	0	0
C <sub>2</sub>	0	0	0	2	0	0	0
D <sub>2</sub>	0	0	0	2	0	0	0
E <sub>2</sub>	E <sub>21</sub>	0	0	0	4	0	0
	E <sub>22</sub>	0	0	0	4	0	0
A <sub>3</sub>	0	0	0	5	0	0	0
B <sub>3</sub>	5	10	15	5	25	50	75
C <sub>3</sub>	0	0	0	5	0	0	0
D <sub>3</sub>	15	15	10	2	30	30	20
E <sub>3</sub>	15	10	15	4	60	40	60
A <sub>4</sub>	0	0	0	5	0	0	0
B <sub>4</sub>	0	0	0	5	0	0	0
C <sub>4</sub>	0	0	0	5	0	0	0
D <sub>4</sub>	0	0	0	4	0	0	0
<b>Total Points</b>					<b>210</b>	<b>225</b>	<b>235</b>

Case 3, Cupboard

Parameters	Ex 1st	Ex 2nd	Ex 3rd	Clinching	Res 1st	Res 2nd	Res 3rd
B <sub>1</sub>	0	0	0	4	0	0	0
C <sub>1</sub>	0	0	0	3	0	0	0
D <sub>1</sub>	0	0	0	0	0	0	0
E <sub>1</sub>	10	5	15	3	30	15	45
A <sub>2</sub>	10	15	5	5	50	75	25
B <sub>2</sub>	0	0	0	4	0	0	0
C <sub>2</sub>	0	0	0	5	0	0	0
D <sub>2</sub>	0	0	0	2	0	0	0
E <sub>2</sub>	E <sub>21</sub>	0	0	4	0	0	0
	E <sub>22</sub>	0	0	4	0	0	0
A <sub>3</sub>	0	0	0	5	0	0	0
B <sub>3</sub>	10	5	15	5	50	25	75
C <sub>3</sub>	0	0	0	5	0	0	0
D <sub>3</sub>	0	0	0	3	0	0	0
E <sub>3</sub>	0	0	0	4	0	0	0
A <sub>4</sub>	0	0	0	3	0	0	0
B <sub>4</sub>	10	15	5	5	50	75	25
C <sub>4</sub>	0	0	0	5	0	0	0
D <sub>4</sub>	0	0	0	4	0	0	0
<b>Total Points</b>					<b>180</b>	<b>190</b>	<b>170</b>

Parameters	Ex 1st	Ex 2nd	Ex 3rd	Blind Riveting	Res 1st	Res 2nd	Res 3rd
B <sub>1</sub>	0	0	0	5	0	0	0
C <sub>1</sub>	0	0	0	3	0	0	0
D <sub>1</sub>	0	0	0	5	0	0	0
E <sub>1</sub>	10	5	15	5	50	25	75
A <sub>2</sub>	10	15	5	4	40	60	20
B <sub>2</sub>	0	0	0	4	0	0	0
C <sub>2</sub>	0	0	0	4	0	0	0
D <sub>2</sub>	0	0	0	2	0	0	0
E <sub>2</sub>	E <sub>21</sub>	0	0	5	0	0	0
	E <sub>22</sub>	0	0	5	0	0	0
A <sub>3</sub>	0	0	0	5	0	0	0
B <sub>3</sub>	10	5	15	3	30	15	45
C <sub>3</sub>	0	0	0	5	0	0	0
D <sub>3</sub>	0	0	0	3	0	0	0
E <sub>3</sub>	0	0	0	4	0	0	0
A <sub>4</sub>	0	0	0	3	0	0	0
B <sub>4</sub>	10	15	5	5	50	75	25
C <sub>4</sub>	0	0	0	5	0	0	0
D <sub>4</sub>	0	0	0	4	0	0	0
<b>Total Points</b>					<b>170</b>	<b>175</b>	<b>165</b>

Parameters	Ex 1st	Ex 2nd	Ex 3rd		Res 1st	Res 2nd	Res 3rd
B <sub>1</sub>		0	0		0	0	0
C <sub>1</sub>	0	0	0	3	0	0	0
D <sub>1</sub>		0	0		0	0	0
E <sub>1</sub>		5	15		50	25	75
A <sub>2</sub>		15	5		50	75	25
B <sub>2</sub>	0	0	0	4	0	0	0
C <sub>2</sub>		0	0		0	0	0
D <sub>2</sub>		0	0		0	0	0
E <sub>2</sub>	E <sub>21</sub>		0		0	0	0
	E <sub>22</sub>		0		0	0	0
A <sub>3</sub>		0	0		0	0	0
B <sub>3</sub>		5	15	3	30	15	45
C <sub>3</sub>		0	0		0	0	0
D <sub>3</sub>		0	0		0	0	0
E <sub>3</sub>		0	0		0	0	0
A <sub>4</sub>		0	0		0	0	0
B <sub>4</sub>		15	5		50	75	25
C <sub>4</sub>		0	0		0	0	0
D <sub>4</sub>		0	0		0	0	0
<b>Total Points</b>					<b>180</b>	<b>190</b>	<b>170</b>

Parameters	Ex 1st	Ex 2nd	Ex 3rd		Res 1st	Res 2nd	Res 3rd
B <sub>1</sub>		0	0		0	0	0
C <sub>1</sub>	0	0	0	3	0	0	0
D <sub>1</sub>		0	0		0	0	0
E <sub>1</sub>		5	15		30	15	45
A <sub>2</sub>		15	5		30	45	15
B <sub>2</sub>	0	0	0	4	0	0	0
C <sub>2</sub>		0	0		0	0	0
D <sub>2</sub>		0	0		0	0	0
E <sub>2</sub>	E <sub>21</sub>		0		0	0	0
	E <sub>22</sub>		0		0	0	0
A <sub>3</sub>		0	0		0	0	0
B <sub>3</sub>		5	15	3	30	15	45
C <sub>3</sub>		0	0		0	0	0
D <sub>3</sub>		0	0		0	0	0
E <sub>3</sub>		0	0		0	0	0
A <sub>4</sub>		0	0		0	0	0
B <sub>4</sub>		15	5		40	60	20
C <sub>4</sub>		0	0		0	0	0
D <sub>4</sub>		0	0		0	0	0
<b>Total Points</b>					<b>130</b>	<b>135</b>	<b>125</b>

Case 3, Cupboard

Parameters	Ex 1st	Ex 2nd	Ex 3rd	Laser Welding	Res 1st	Res 2nd	Res 3rd
B <sub>1</sub>	0	0	0	4	0	0	0
C <sub>1</sub>	0	0	0	3	0	0	0
D <sub>1</sub>	0	0	0	4	0	0	0
E <sub>1</sub>	10	5	15	2	20	10	30
A <sub>2</sub>	10	15	5	1	10	15	5
B <sub>2</sub>	0	0	0	3	0	0	0
C <sub>2</sub>	0	0	0	5	0	0	0
D <sub>2</sub>	0	0	0	5	0	0	0
E <sub>2</sub>	E <sub>21</sub>	0	0	5	0	0	0
	E <sub>22</sub>	0	0	5	0	0	0
A <sub>3</sub>	0	0	0	2	0	0	0
B <sub>3</sub>	10	5	15	3	30	15	45
C <sub>3</sub>	0	0	0	3	0	0	0
D <sub>3</sub>	0	0	0	5	0	0	0
E <sub>3</sub>	0	0	0	4	0	0	0
A <sub>4</sub>	0	0	0	1	0	0	0
B <sub>4</sub>	10	15	5	4	40	60	20
C <sub>4</sub>	0	0	0	2	0	0	0
D <sub>4</sub>	0	0	0	0	0	0	0
<b>Total Points</b>					<b>100</b>	<b>100</b>	<b>100</b>

Parameters	Ex 1st	Ex 2nd	Ex 3rd	Projection Welding	Res 1st	Res 2nd	Res 3rd
B <sub>1</sub>	0	0	0	0	0	0	0
C <sub>1</sub>	0	0	0	1	0	0	0
D <sub>1</sub>	0	0	0	0	0	0	0
E <sub>1</sub>	10	5	15	2	20	10	30
A <sub>2</sub>	10	15	5	2	20	30	10
B <sub>2</sub>	0	0	0	4	0	0	0
C <sub>2</sub>	0	0	0	2	0	0	0
D <sub>2</sub>	0	0	0	2	0	0	0
E <sub>2</sub>	E <sub>21</sub>	0	0	5	0	0	0
	E <sub>22</sub>	0	0	5	0	0	0
A <sub>3</sub>	0	0	0	2	0	0	0
B <sub>3</sub>	10	5	15	5	50	25	75
C <sub>3</sub>	0	0	0	1	0	0	0
D <sub>3</sub>	0	0	0	5	0	0	0
E <sub>3</sub>	0	0	0	1	0	0	0
A <sub>4</sub>	0	0	0	1	0	0	0
B <sub>4</sub>	10	15	5	3	30	45	15
C <sub>4</sub>	0	0	0	5	0	0	0
D <sub>4</sub>	0	0	0	0	0	0	0
<b>Total Points</b>					<b>120</b>	<b>110</b>	<b>130</b>

Parameters	Ex 1st	Ex 2nd	Ex 3rd		Res 1st	Res 2nd	Res 3rd
B <sub>1</sub>		0	0	5	0	0	0
C <sub>1</sub>	0	0	0	5	0	0	0
D <sub>1</sub>		0	0	5	0	0	0
E <sub>1</sub>		5	15	1	10	5	15
A <sub>2</sub>		15	5		20	30	10
B <sub>2</sub>	0	0	0	4	0	0	0
C <sub>2</sub>		0	0		0	0	0
D <sub>2</sub>		0	0		0	0	0
E <sub>2</sub>	E <sub>21</sub>		0		0	0	0
	E <sub>22</sub>		0		0	0	0
A <sub>3</sub>		0	0		0	0	0
B <sub>3</sub>		5	15	3	30	15	45
C <sub>3</sub>		0	0		0	0	0
D <sub>3</sub>		0	0		0	0	0
E <sub>3</sub>		0	0		0	0	0
A <sub>4</sub>		0	0		0	0	0
B <sub>4</sub>		15	5		50	75	25
C <sub>4</sub>		0	0		0	0	0
D <sub>4</sub>		0	0		0	0	0
<b>Total Points</b>					<b>110</b>	<b>125</b>	<b>95</b>

Parameters	Ex 1st	Ex 2nd	Ex 3rd		Res 1st	Res 2nd	Res 3rd
B <sub>1</sub>		0	0	5	0	0	0
C <sub>1</sub>	0	0	0	3	0	0	0
D <sub>1</sub>		0	0	4	0	0	0
E <sub>1</sub>		5	15	1	10	5	15
A <sub>2</sub>		15	5	1	10	15	5
B <sub>2</sub>	0	0	0	4	0	0	0
C <sub>2</sub>		0	0	5	0	0	0
D <sub>2</sub>		0	0	5	0	0	0
E <sub>2</sub>	E <sub>21</sub>		0	5	0	0	0
	E <sub>22</sub>		0	5	0	0	0
A <sub>3</sub>		0	0	5	0	0	0
B <sub>3</sub>		5	15	3	30	15	45
C <sub>3</sub>		0	0	5	0	0	0
D <sub>3</sub>		0	0	4	0	0	0
E <sub>3</sub>		0	0	4	0	0	0
A <sub>4</sub>		0	0	2	0	0	0
B <sub>4</sub>		15	5	5	50	75	25
C <sub>4</sub>		0	0	5	0	0	0
D <sub>4</sub>		0	0	3	0	0	0
<b>Total Points</b>					<b>100</b>	<b>110</b>	<b>90</b>

Case 3, Cupboard

Parameters	Ex	Ex	Ex	Self-Clip	Res	Res	Res	
	1st	2nd	3rd		1st	2nd	3rd	
B <sub>1</sub>	0	0	0	4	0	0	0	
C <sub>1</sub>	0	0	0	3	0	0	0	
D <sub>1</sub>	0	0	0	0	0	0	0	
E <sub>1</sub>	10	5	15	5	50	25	75	
A <sub>2</sub>	10	15	5	5	50	75	25	
B <sub>2</sub>	0	0	0	4	0	0	0	
C <sub>2</sub>	0	0	0	2	0	0	0	
D <sub>2</sub>	0	0	0	2	0	0	0	
E <sub>2</sub>	E <sub>21</sub>	0	0	0	4	0	0	0
	E <sub>22</sub>	0	0	0	4	0	0	0
A <sub>3</sub>	0	0	0	5	0	0	0	
B <sub>3</sub>	10	5	15	5	50	25	75	
C <sub>3</sub>	0	0	0	5	0	0	0	
D <sub>3</sub>	0	0	0	2	0	0	0	
E <sub>3</sub>	0	0	0	4	0	0	0	
A <sub>4</sub>	0	0	0	4	0	0	0	
B <sub>4</sub>	10	15	5	5	50	75	25	
C <sub>4</sub>	0	0	0	5	0	0	0	
D <sub>4</sub>	0	0	0	4	0	0	0	
<b>Total Points</b>					<b>200</b>	<b>200</b>	<b>200</b>	